



SURGICAL INSTRUMENTS



Sagalain International

Manufacturer & Exporters of all kinds of Surgical Instruments

Email: info@sagalain.com

Web: www.sagalain.com



Shabbir Hussain Shabbir
Founder



Sultan Haider Shabbir
Chief Executive

WARRANTY CERTIFICATE

The reusable medical devices (*Surgical - Dental, & Veterinary Instruments*) are fabricated by *Sagalain International* from high quality Stainless Steel of Standard Specification. Using high Quality control checks with Boil testing and Passivation, we fully assure conformity with specified requirements.

We stand guarantee for any malfunction or non-conformity whatsoever.

Our this warranty stands valid for Five Years, but does not cover damages caused due to users negligence or improper care.

All Doctors & Hospitals prefer to use "*Sagalain*" Instruments throughout the world.

FOREWORD

Saqalain International engage in the manufacturing & exporting of Veterinary Instruments, since 1957, are steadily improving due to the use of modern implements and applications of Scientific research methods, as well as the skilled team of experts employed, which ensure the high quality instruments and apparatus illustrated in this catalogue.

We have prepared this catalogue, which have included most modern Veterinary Instruments, and in case you are interested in such other items not illustrated and mentioned in it. Please bring those into our notice, and then we will immediately submit our samples and most competitive prices for your consideration.

Our factory is well equipped with modern machinery, and engaged highly skilled labor, which help us in improving our standard, and this factor make our prices most competitive.

Please just drop a letter or fax us, and we will be immediately be at your service.

Our organization is cGMP, ISO-9001 : ISO-13485 & CE Mark Certified.

With Best Regards.



Revised 4th Edition
Date: Year 2013

Saqalain International

"Shabbir Villa" Khadim Ali Road,
P.O.Box 2716, Sialkot - Pakistan

Tel : + 92-52-3552000, 3550200

Fax: + 92-52-3559642

Email: info@saqalain.com

<http://www.saqalain.com>



01-101
TROEMNER
Size: 245 mm



01-102
DEJERINE
Size: 200 mm



01-103
DEJERINE
With Needle
Size: 210 mm



01-104
TAYLOR
Size: 195 mm



01-105
BERLINER
Size: 200 mm



01-106
BUCK
With Needle
And Brush
Size: 180 mm



01-107
RABINER
With Needle
And Brush
Size: 255 mm



01-108
ALY
Size: 190 mm



01-109
WARTENBERG
Pinwheel For
Neurological
Examination
Size: 185 mm



01-110
PINARD (Aluminum)
Size: 155 mm



01-111
aus Holz (Wooden)
Size: 145 mm



01-112
BOWLES
Stethoscope
With Diaphragm



01-113
ANESTOPHON



01-114
FORD-BOWLES
Duel Chest Piece
With Two Outlets



01-115
BOWLES

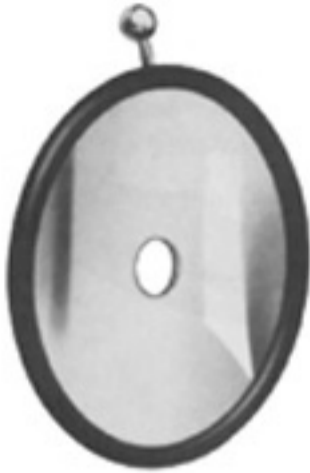

01-116
ZIEGLER Ø mm
Head mirror only
with rubber coating

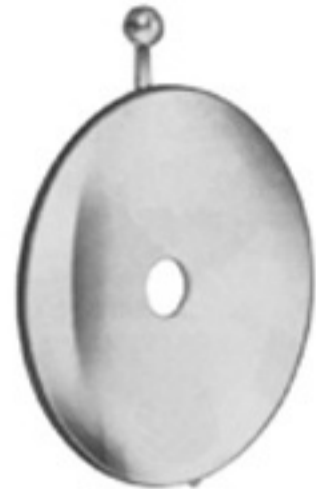

01-117
ZIEGLER Ø mm
Head mirror only
with metal coating



01-118
ZIEGLER
Head band of plastic black

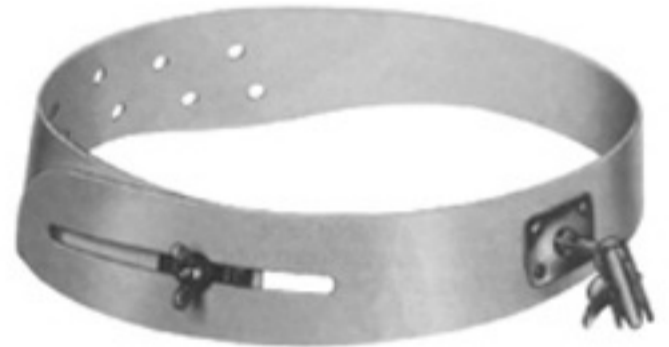

01-120
MURPHY
Head band of celluloid, white

01-119
ZIEGLER
Head band of plastic white



01-121
Head band of plastic,
white, soft pattern



01-122
Head mirror with black
plastic head band.

01-123

CLAR

Head light, 6 volt, with adjustable joint,
white celluloid head band,
cord with plugs for transformer

01-124

White celluloid head band, only, for

01-125

Spare mirror only, for



01-127

CLAR

Head light, 6 volt, with adjustable joint,
white celluloid head band, with foam rubber pad
and cord with plugs for transformer

01-128

White celluloid head band, only, for head light

01-129

mirror only, for head light

spare foam rubber pad, for head band



01-131

CLAR

Head light, 6 volt, with adjustable joint,
white plastic head band,
cord with plugs for transformer



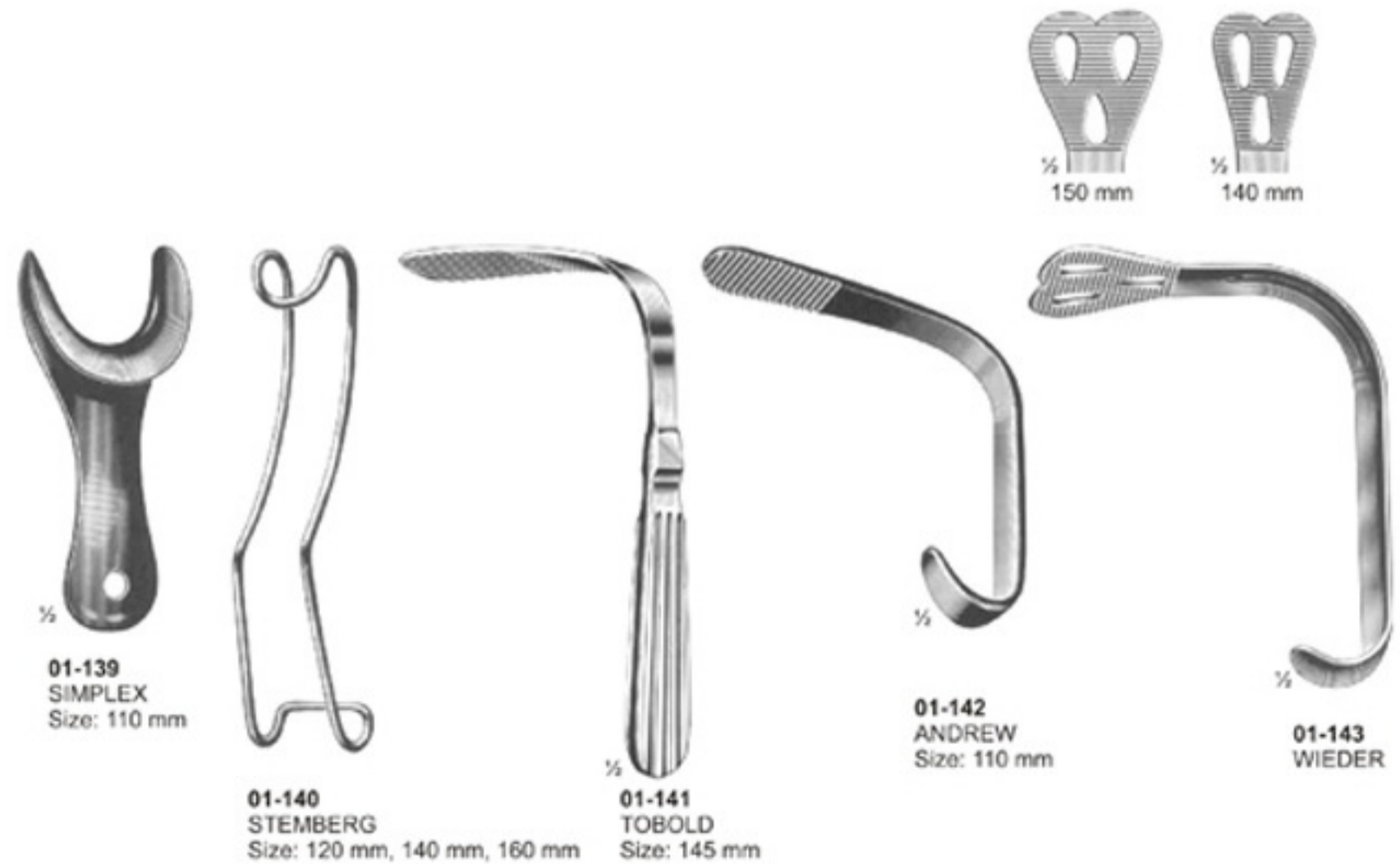
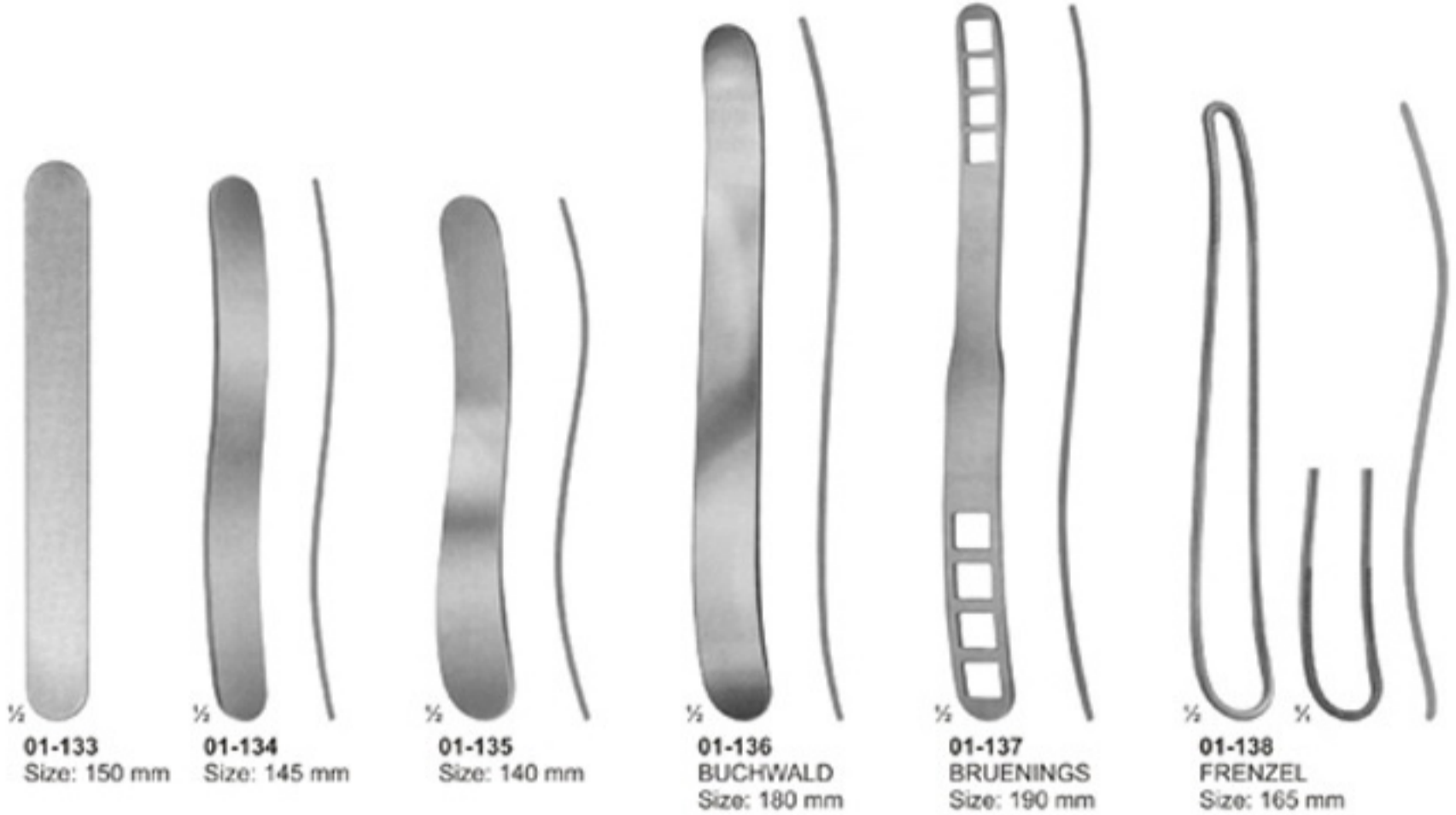



1/2
01-144
SCHIMMELBUSCH
Ether Mask



1/2
01-145
HEISTER
Mouth Gag
Size: 130 mm



1/2
01-146
FERGUSON-ACKLAND
Mouth Gag
Size: 145 mm



1/2
01-147
DENHARDT
Mouth Gag With Silicon
Inserts, Interchangeable
Size: 125 mm



1/2
01-148
ROSER KONIG
Mouth Gag
Size: 160 mm, 185 mm

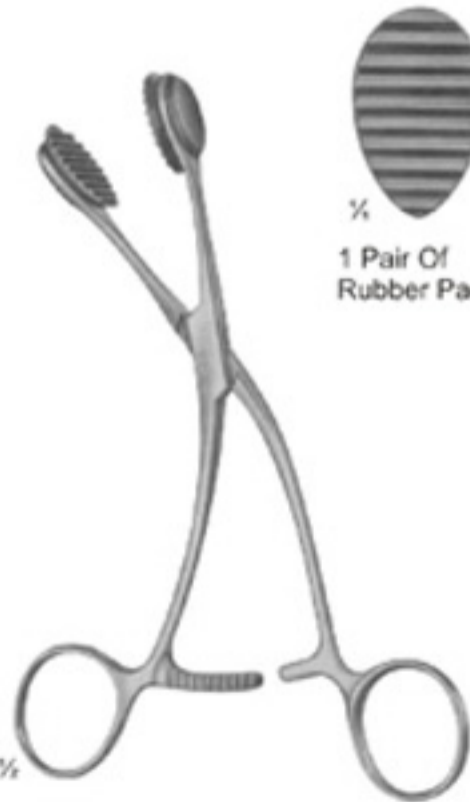

1/2
01-149
YOUNG
Size: 165 mm



1/2
1 Pair Of
Rubber Pads

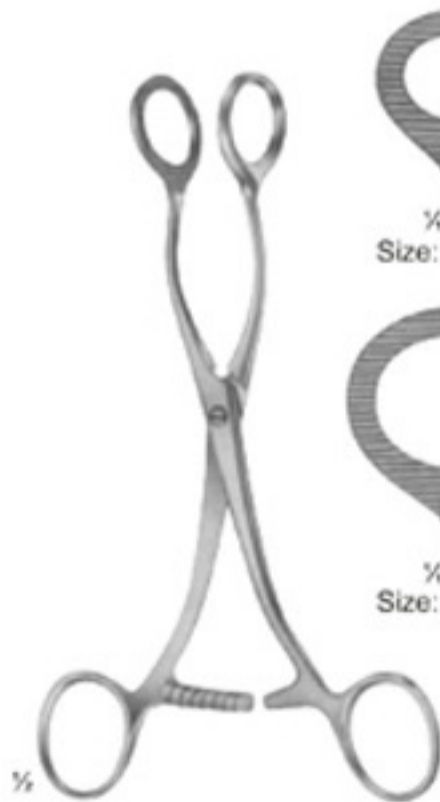

1/2
01-150
COLLIN
Size: 160 mm, 170 mm

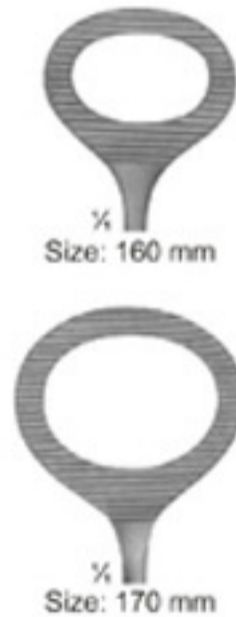

1/2
Size: 160 mm

1/2
Size: 170 mm



1/2
01-151
HEYWOOD-SMITH modif.
Size: 215 mm

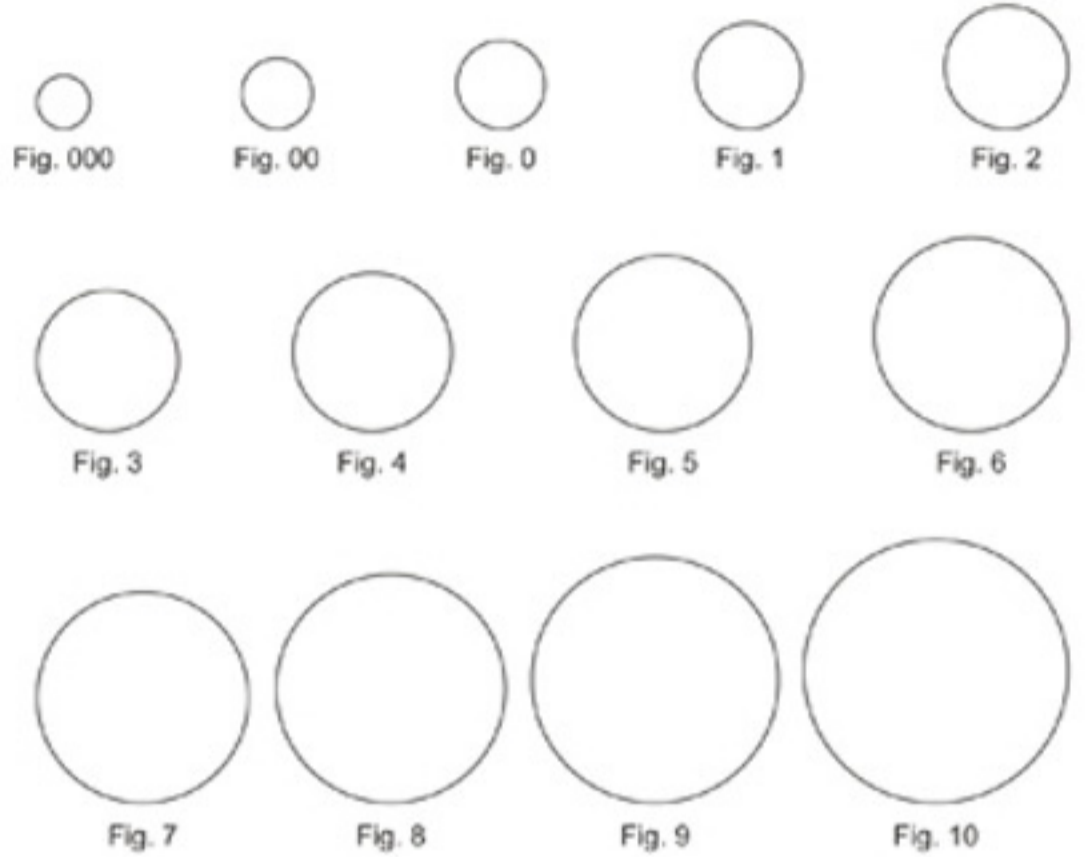



1/2
01-160 - 162
MAGILL



01-160
Infants
Size: 150 mm



01-161
Children
Size: 200 mm



01-162
Adults
Size: 250 mm



1/2
01-163
Medium battery handle
only, 25 mm diam.



01-163-A
Spare bulb
2.7 volt, for
otoscopes



01-163-B
Spare bulb
2.6 volt, for
ophthalmoscopes



01-164
Otoscope Set, Consists Of
Battery Handle Without Batteries,
3 Ear Specula, 1 Bulb In Velvet Lined Case



01-165
Diagnostic Set, Otoscope With Three Specula,
Nasal Speculum, Lamp Holder, Two Laryngeal
Mirrors, Tongue Blade Holder



01-166
MILLER
 Laryngoscope Set, Consists Of Battery Handle (Without Battery)
 With Four Miller Laryngoscope Blades

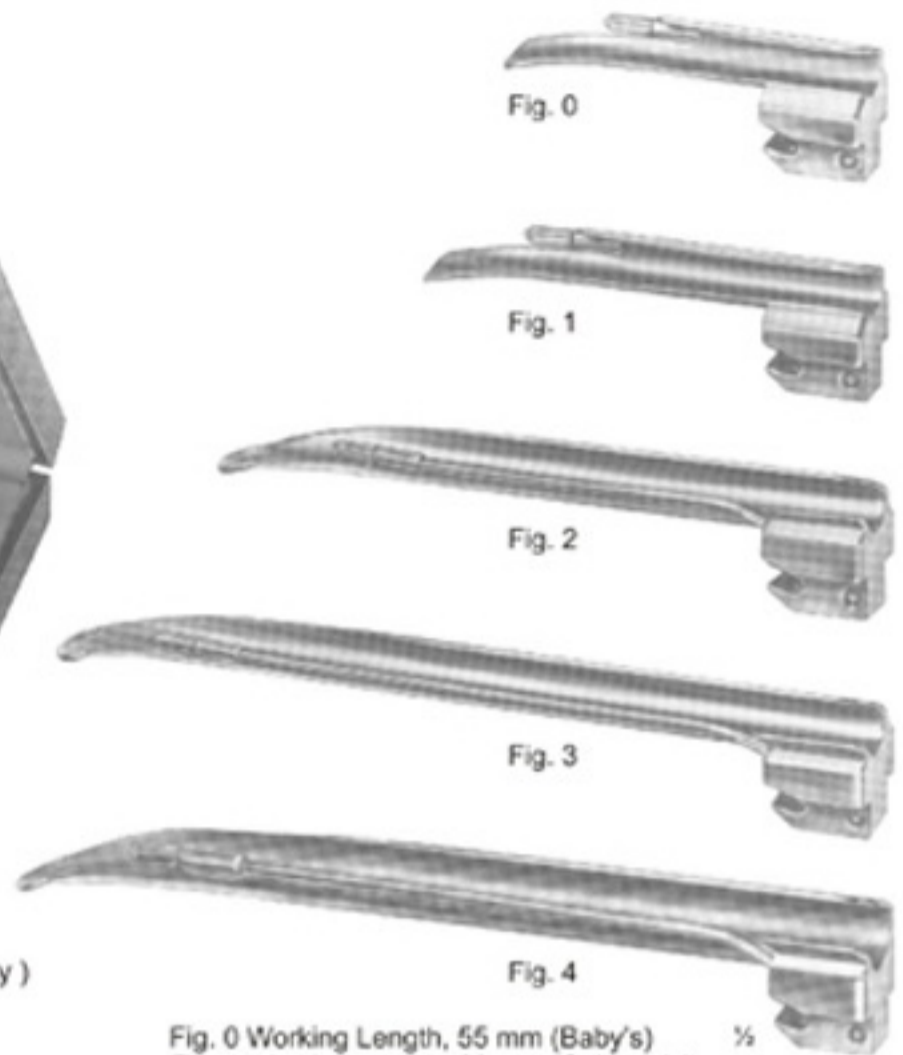

Fig. 0 Working Length, 55 mm (Baby's)
 Fig. 1 Working Length, 80 mm (Children's)
 Fig. 2 Working Length, 130 mm (Adolescent's)
 Fig. 3 Working Length, 170 mm (Women's)
 Fig. 4 Working Length, 180 mm (Men's)



01-167
GUEDEL-NEGUS
 Laryngoscope Set, Consists Of Battery Handle (Without Battery)
 With Four Miller Laryngoscope Blades



Fig. 1 Working Length, 70 mm (Children's)
 Fig. 2 Working Length, 90 mm (Adolescent's)
 Fig. 3 Working Length, 110 mm (Women's)
 Fig. 4 Working Length, 135 mm (Men's)



01-168
McIntosh
Laryngoscope Set, Consists Of Battery Handle (Without Battery)
With Three McIntosh Blades, Fig. 1, Fig. 2, Fig. 3

01-169
McIntosh
Laryngoscope Set, Consists Of Battery Handle (Without Battery)
With Five McIntosh Blades, Fig. 1, Fig. 2, Fig. 3, Fig. 4, Fig. 5



Fig. 0



Fig. 1



Fig. 2



Fig. 3



Fig. 4

- Fig. 0 Working Length, 55 mm (Baby's)
- Fig. 1 Working Length, 75 mm (Children's)
- Fig. 2 Working Length, 90 mm (Adolescent's)
- Fig. 3 Working Length, 110 mm (Women's)
- Fig. 4 Working Length, 135 mm (Men's)

01-170
FOREGGER
Laryngoscope Set, Consists Of
Battery Handle (Without Battery)
With Three Foregger Blades,
Fig. 1, Fig. 2, Fig. 3,



01-171
FOREGGER
Laryngoscope Set, Consists Of
Battery Handle (Without Battery)
With Five Foregger Blades,
Fig. 1, Fig. 2, Fig. 3, Fig. 4, Fig. 5



Fig. 1



Fig. 2



Fig. 3

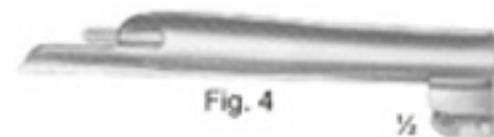

Fig. 4

- Fig. 1 Working Length, 70 mm (Children's)
- Fig. 2 Working Length, 90 mm (Adolescent's)
- Fig. 3 Working Length, 110 mm (Women's)
- Fig. 4 Working Length, 135 mm (Men's)



01-172
Fiber Optic
Battery Handle



01-173
Fiber Optic
Battery Handle



01-174
Replacement Lamp
(Krypton) 2.5 V



01-175
Replacement Lamp
(Halogen) 2.5 V



01-176
Caliper Of Aluminum
Up To 180 mm



01-177
VERNIER
Universal Caliper Of Steel
Up To 120 mm



01-178
CAROLL
Size: 140 mm



01-179
TOWNLEY
Size: 100 mm



01-180
COLLIN
Druck Pressure 72 kg
Size: 125 mm



01-181
BERTILLON
Caliper For Measuring The Head
Size: 320 mm



01-182
CASTROVIEJO
Caliper



01-183
MOLTGEN
Goniometer

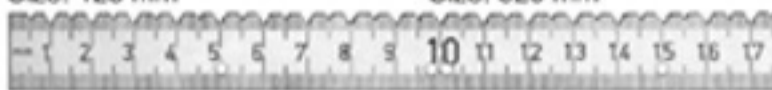

01-184
Size: 500 mm



01-185



1/2

02-101 - 110
Fig. 1 - 10



1/2

02-101
Fig. 1



02-102
Fig. 2



02-103
Fig. 3



02-104
Fig. 4



02-105
Fig. 5



1/2

02-106
Fig. 6



02-107
Fig. 7



02-108
Fig. 8



02-109
Fig. 9



02-110
Fig. 10

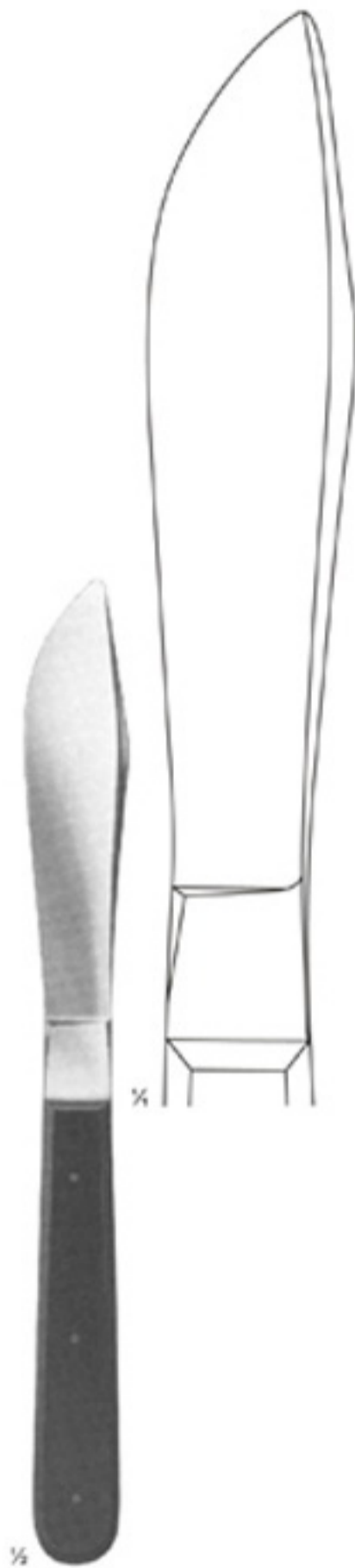

02-111
Size: 255 mm

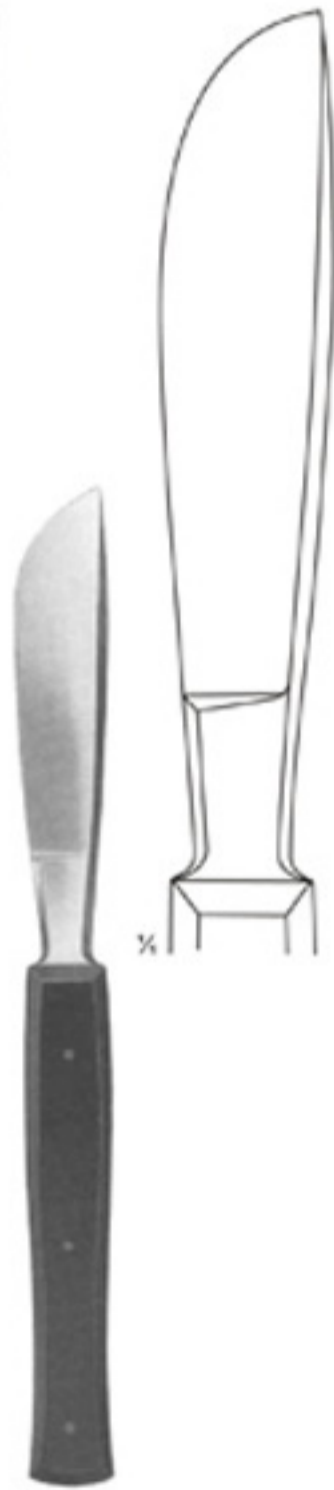

02-112
VIRCHOW



02-113 - 115
WALB

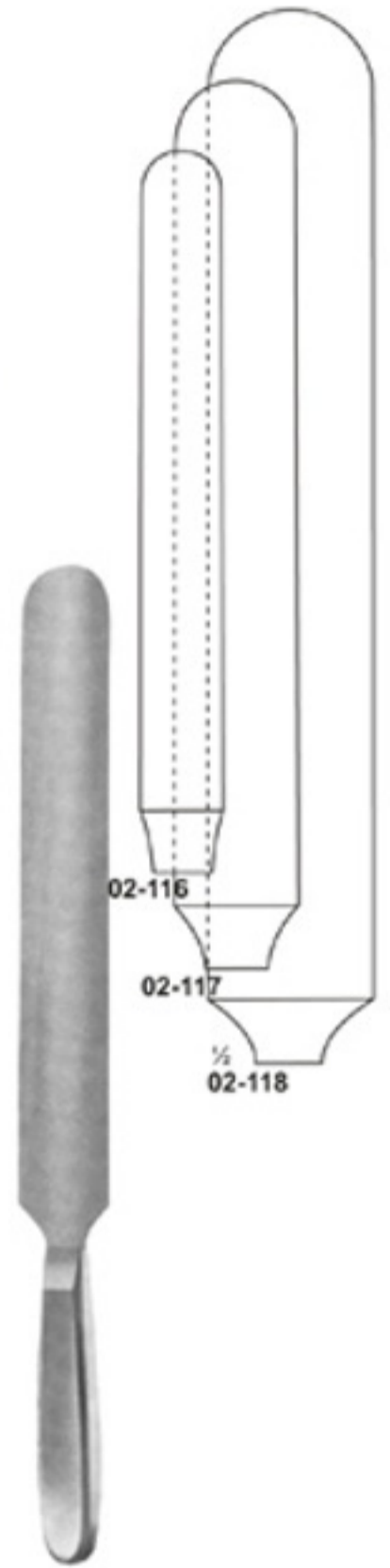
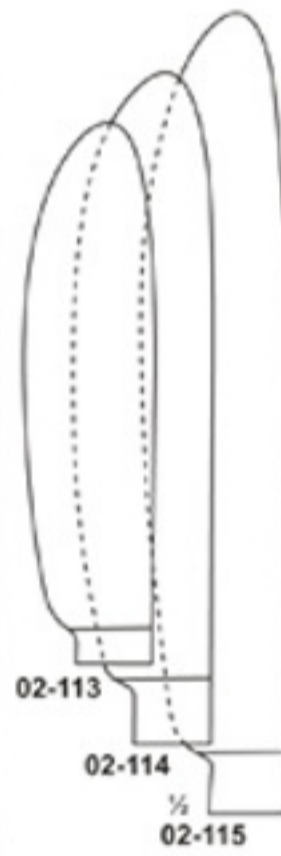

02-116 - 118
VIRCHOW

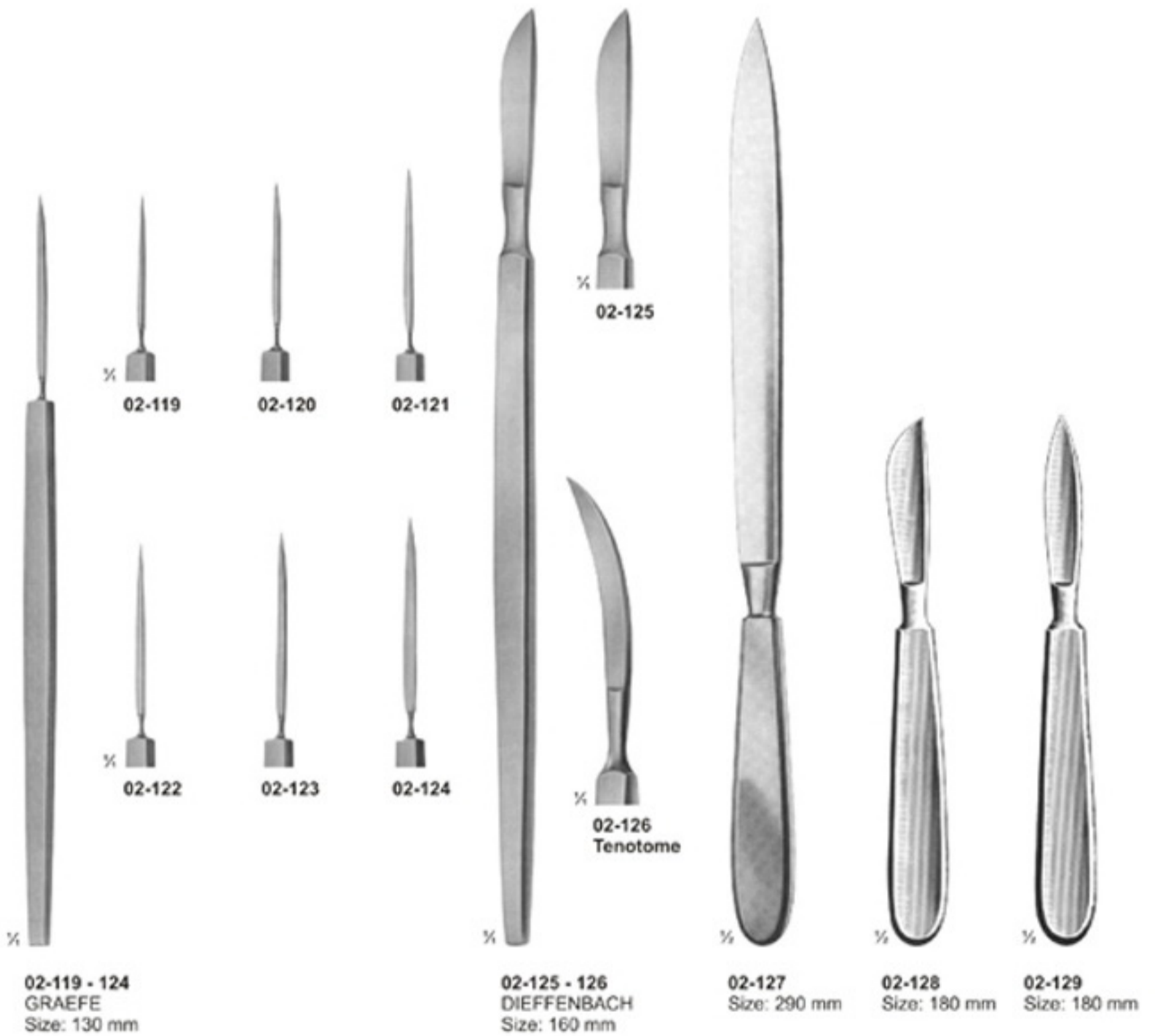

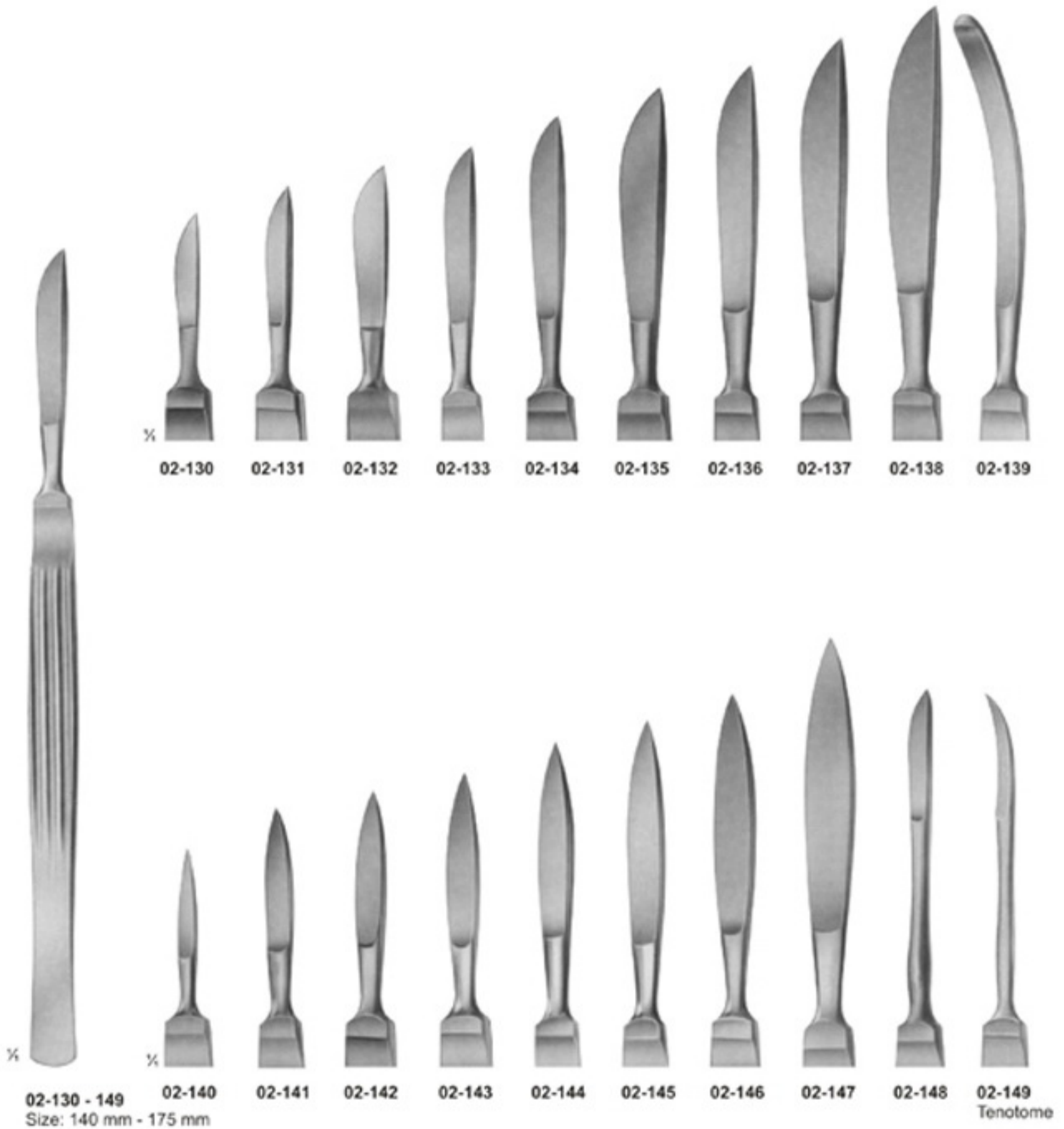



02-150 Size: 130 mm	02-154 CATLIN Size: 160 mm	02-155 LANGENBECK Size: 120 mm	02-156 Size: 110 mm	02-157 Size: 55 mm	02-158 Size: 70 mm	02-159 Size: 80 mm	02-160 Size: 195 mm
02-151 Size: 160 mm	Blade Length	Blade Length	Blade Length	Blade Length	Blade Length	Blade Length	Blade Length
02-152 Size: 190 mm	Amputating	Flap Knives	Interosseous	With Raspatory,	Wooden Handle	Metal Handle	Metal Handle
02-153 Size: 200 mm	Knives	Knives	Knives	Wooden Handle			

Blade Length
Amputating Knives



02-161
AYRE
 Size: 235 mm
 Cone Knife

02-162
 Size: 230 mm
 Cone Knife

02-163
SEGOND
 Size: 270 mm
 Myomatome

02-164
OLIVECRONA
 Size: 205 mm
 Trigeminal
 Knife

02-165
 Size: 230 mm
 Trigeminal
 Knife

02-166
FOWLER
 Size: 200 mm
 Tonsil Knife

02-167
ABRAHAM
 Size: 215 mm
 Tonsil Knife

02-168
BRUNINGS
 Size: 215 mm
 Tonsil Knife



02-169
Straight

02-170
Curved

02-169 - 170
JOSEPH
Size: 145 mm
Double Edged
Nasal Knives, Pointed

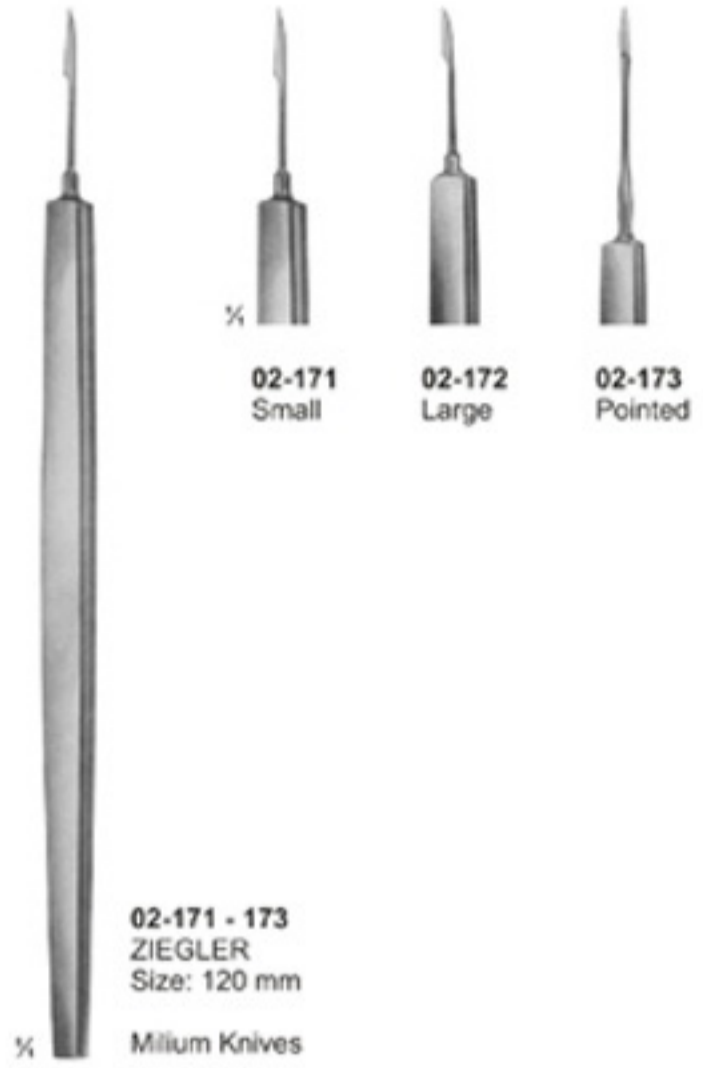

02-171
Small

02-172
Large

02-173
Pointed

02-171 - 173
ZIEGLER
Size: 120 mm
Milium Knives



02-174
VIDAL
Lupus Scraper
Size: 135 mm



02-175
MONCORPS
Milium Knives
Size: 130 mm



02-176
SAALFELD
Size: 100 mm

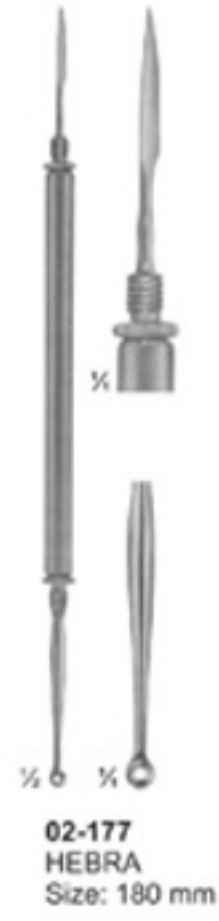

02-177
HEBRA
Size: 180 mm

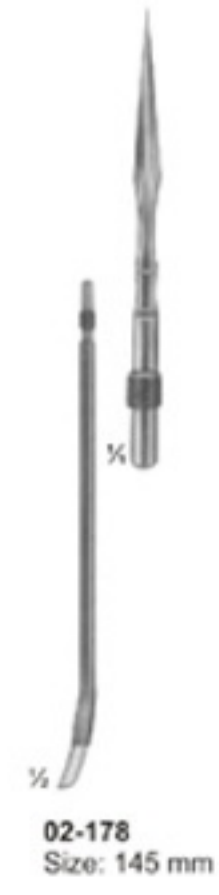

02-178
Size: 145 mm



02-179
UNNA
Size: 145 mm



02-180
TROUTMAN-CHRIS
Size: 100 mm



02-181
TROUTMAN-CHRIS
Size: 100 mm



02-182
Size: 110 mm



02-183
CASTROVIEJO
Size: 130 mm



02-184
Size: 185 mm



02-185
STANDARD
No. 4
Solid

02-186
Double Handel
No. 4 + No. 3
Solid

02-187
No. 4 L
Straight
Solid

02-188
No. 4 L
Solid Angled

02-189
COLLIN
No. 8
Hollow

02-190
COLLIN
No. 9
Hollow

02-191
Plastic

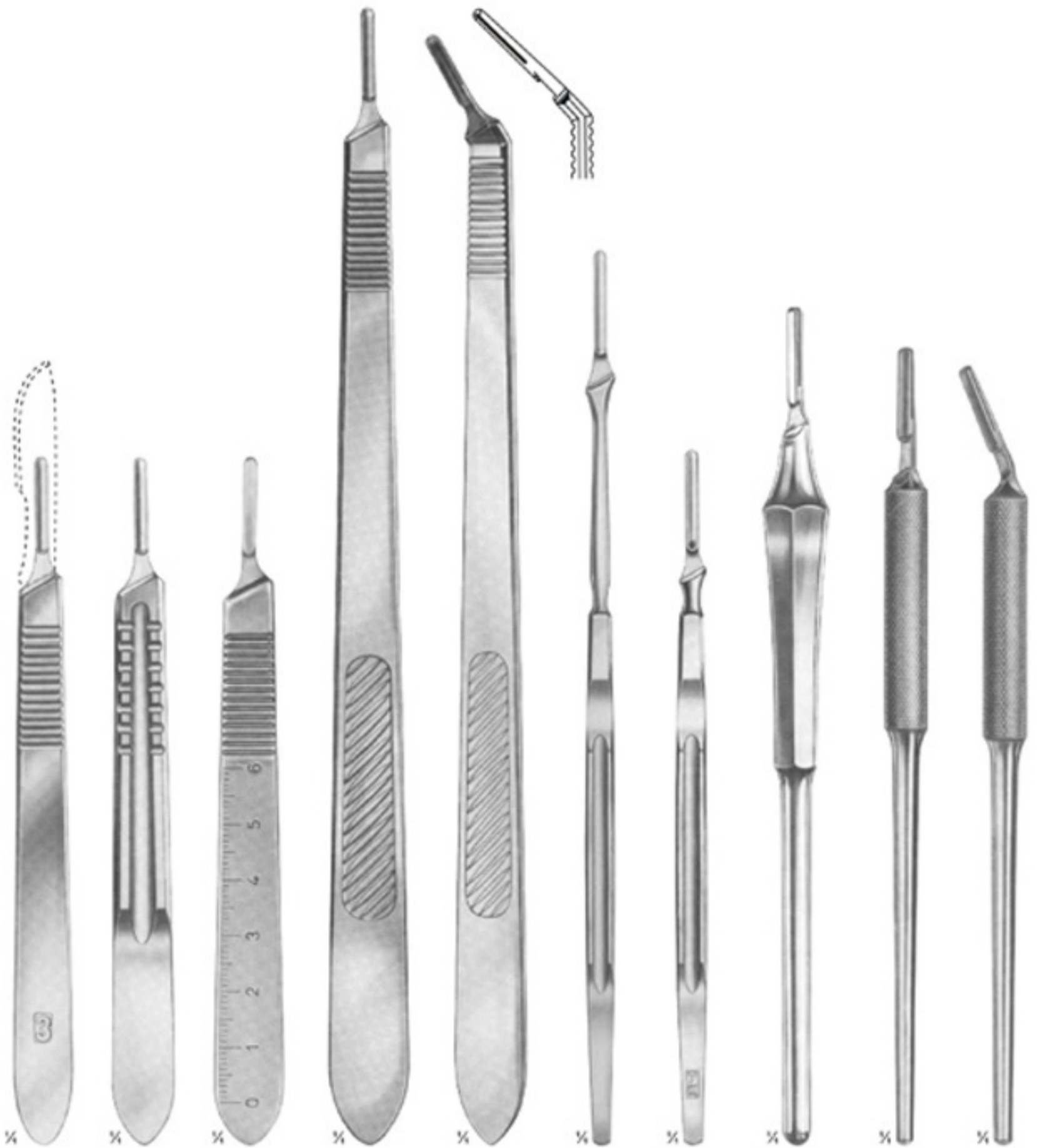

02-192
STANDARD
No. 3
Solid

02-193
No. 3
Solid

02-194
No. 3
Solid

02-195
No. 3 L
Straight
Solid

02-196
No. 3 L
Angled
Solid

02-197
No. 7
Solid

02-198
No. 7 K
Solid

02-199
Hollow-Round

02-200
No. 3
Straight
Solid

02-201
No. 3
Angled
Solid

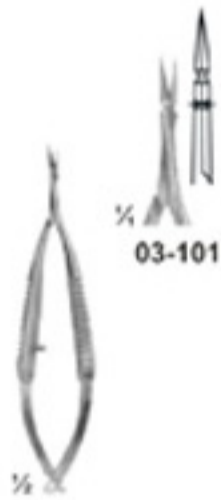

03-101



03-102



03-103

03-101 - 103
VANNAS
Size: 85 mm



03-104



03-105

03-104 - 105
CASTROVIEJO
Size: 95 mm

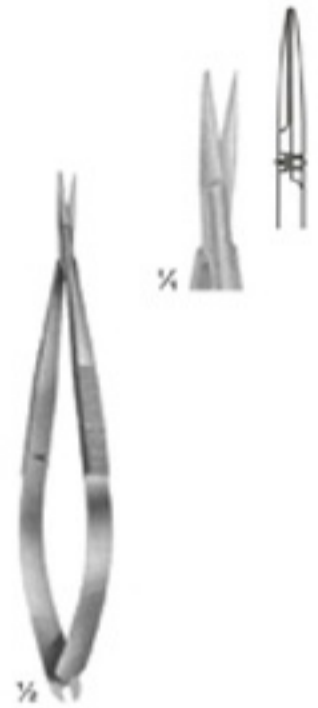

03-106
NOYES
Size: 125 mm

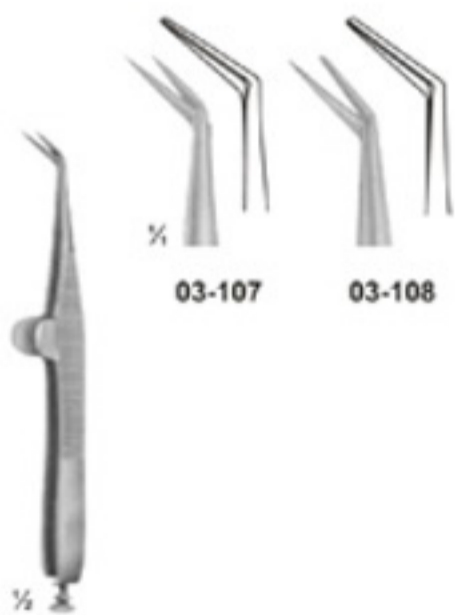

03-107



03-108

03-107 - 108
WECKER
Eye Scissor
Size: 110 mm



03-109

03-109
CASTROVIEJO
Eye Scissor
Size: 115 mm

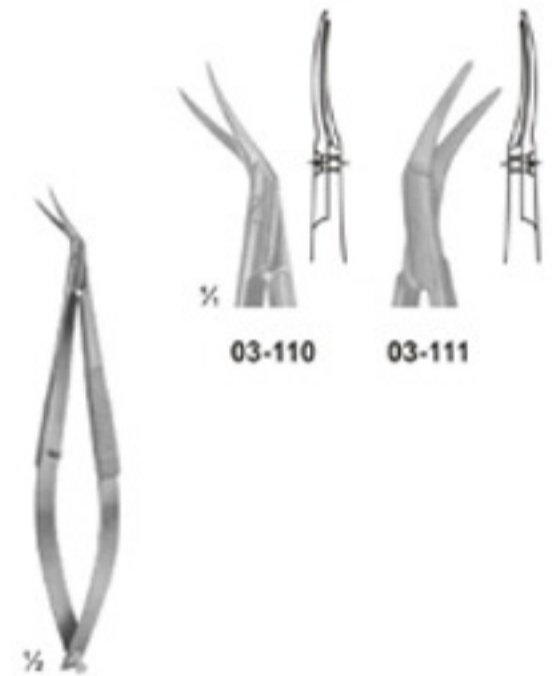

03-110



03-111

03-110 - 111
CASTROVIEJO
Eye Scissor
Size: 110 mm

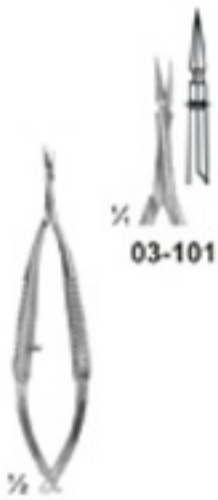

03-101



03-102



03-103

03-101 - 103
VANNAS
Size: 85 mm



03-104



03-105

03-104 - 105
CASTROVIEJO
Size: 95 mm



03-106
NOYES
Size: 125 mm



03-107



03-108

03-107 - 108
WECKER
Eye Scissor
Size: 110 mm



03-109

03-109
CASTROVIEJO
Eye Scissor
Size: 115 mm



03-110



03-111

03-110 - 111
CASTROVIEJO
Eye Scissor
Size: 110 mm

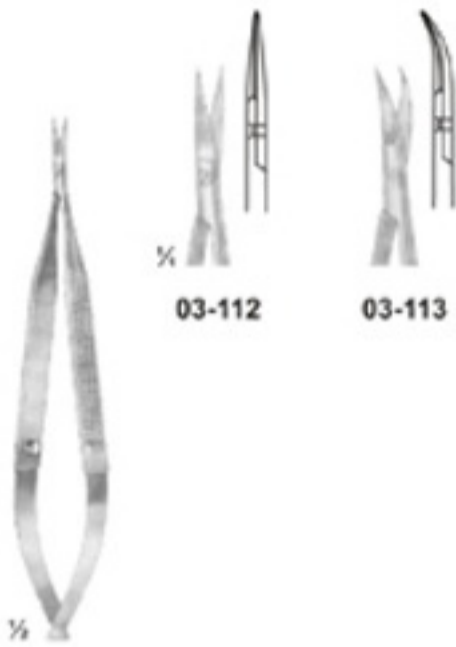

03-112 - 113
Size: 120 mm



03-114
BIEMER
Vein Scissor
Size: 130 mm

03-115
Size: 160 mm

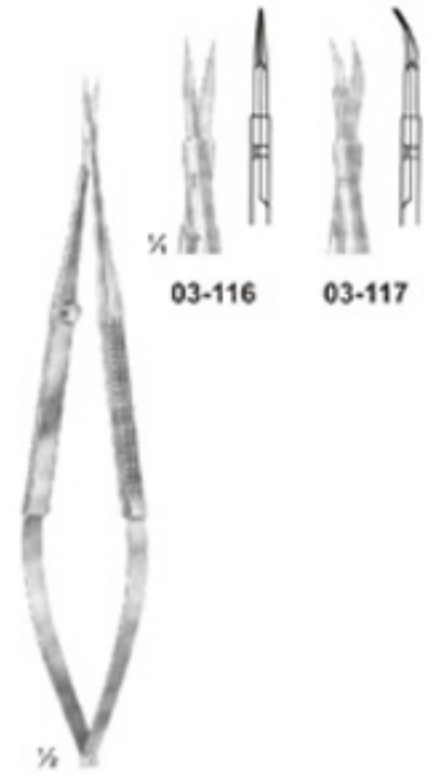

03-116 - 117
VANNAS
Size: 160 mm

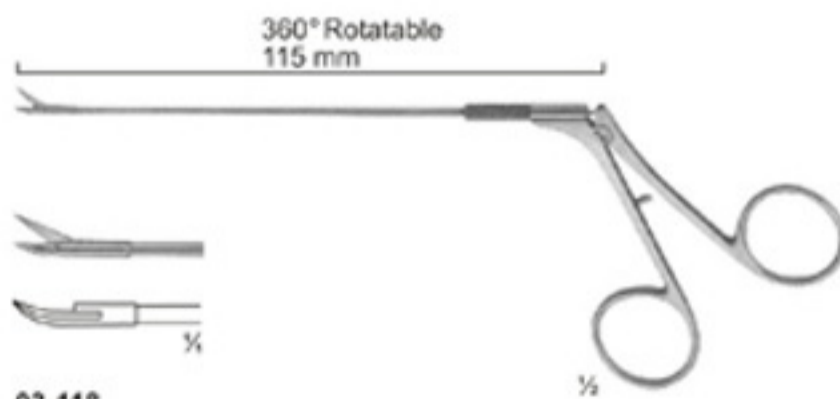

03-118
CASPAR
Micro Scissor Curved
Size: 115 mm

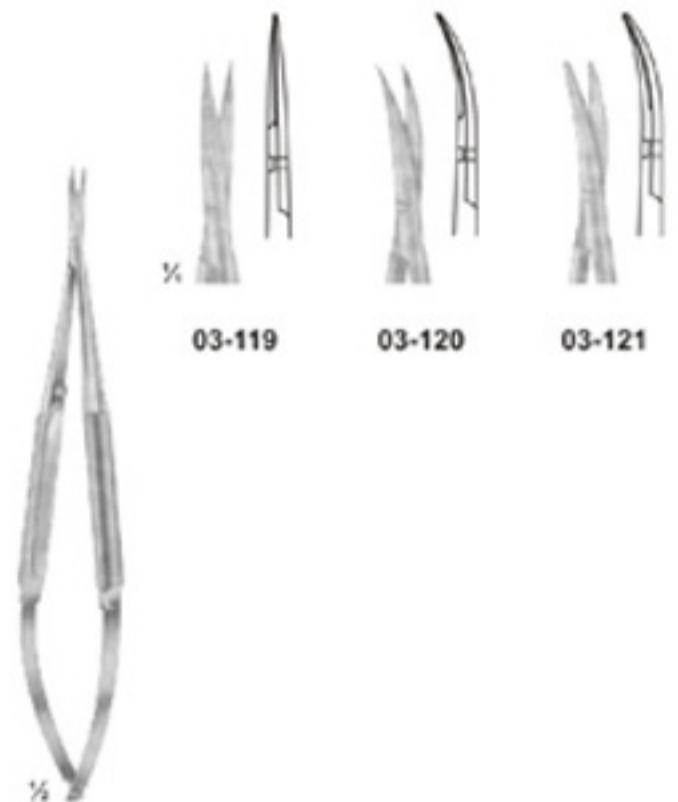

03-119 - 121
Micro Dissecting Scissor
Size: 145 mm



03-122
YASARGIL
Size: 245 mm



03-123



03-124

03-123 - 124
Laterally Angled
Size: 200 mm



03-125
Laterally Angled
Size: 190 mm



03-126

03-127



03-126 - 127
YASARGIL
Size: 225 mm

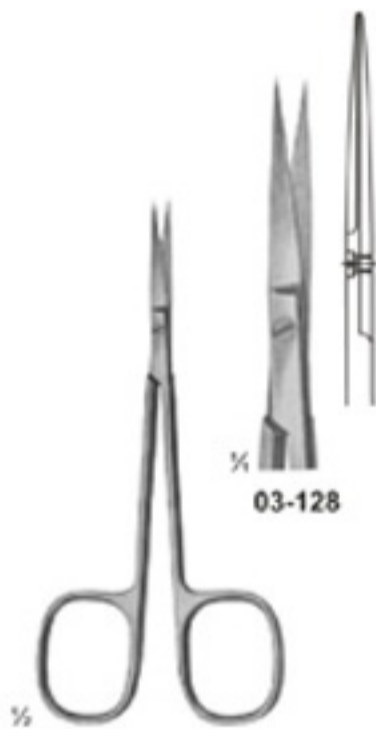

03-128



03-129

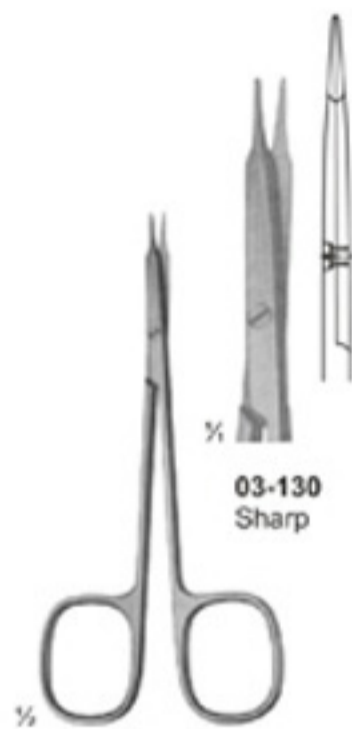

03-130
Sharp



03-131
Sharp



03-132
Blunt



03-133
Blunt

03-128 - 129
Size: 120 mm

03-130 - 133
STEVENS
Dissecting Scissors
Size: 115 mm

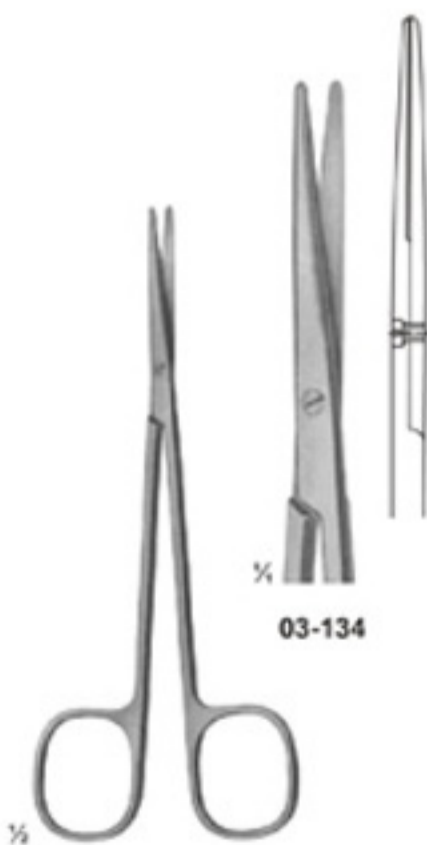

03-134



03-135

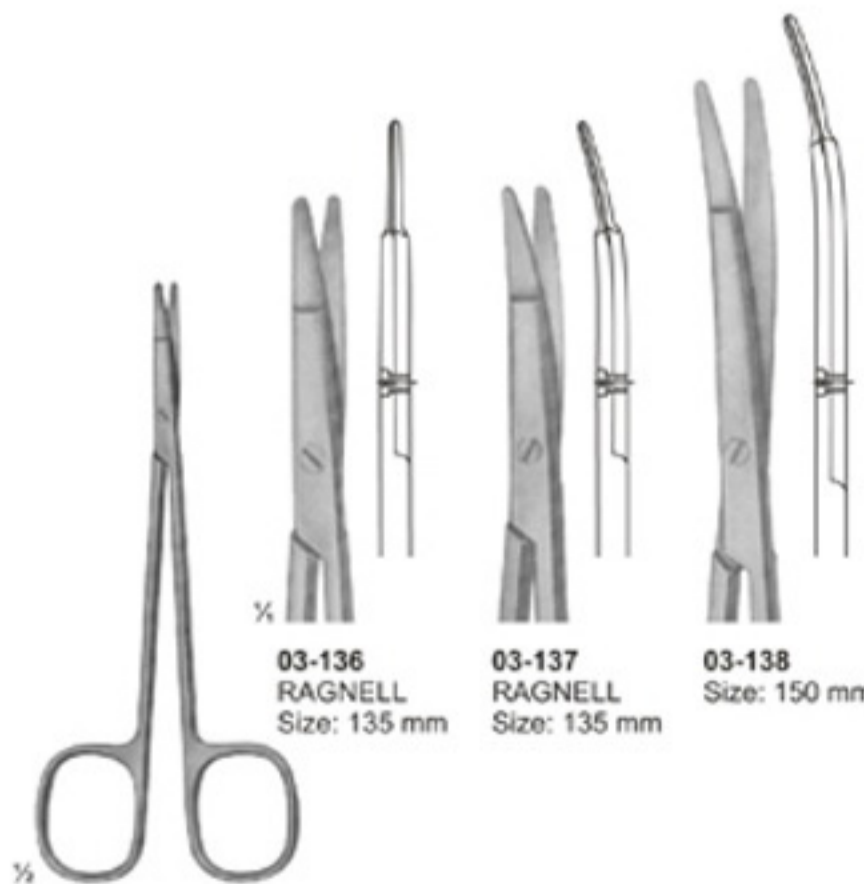

03-136
RAGNELL
Size: 135 mm

03-137
RAGNELL
Size: 135 mm

03-138
Size: 150 mm

03-134 - 135
METZENBAUM
Dissecting Scissors
Size: 145 mm

03-136 - 138
Special flat points for
dissecting and
undermining the skin
Size: 145 mm

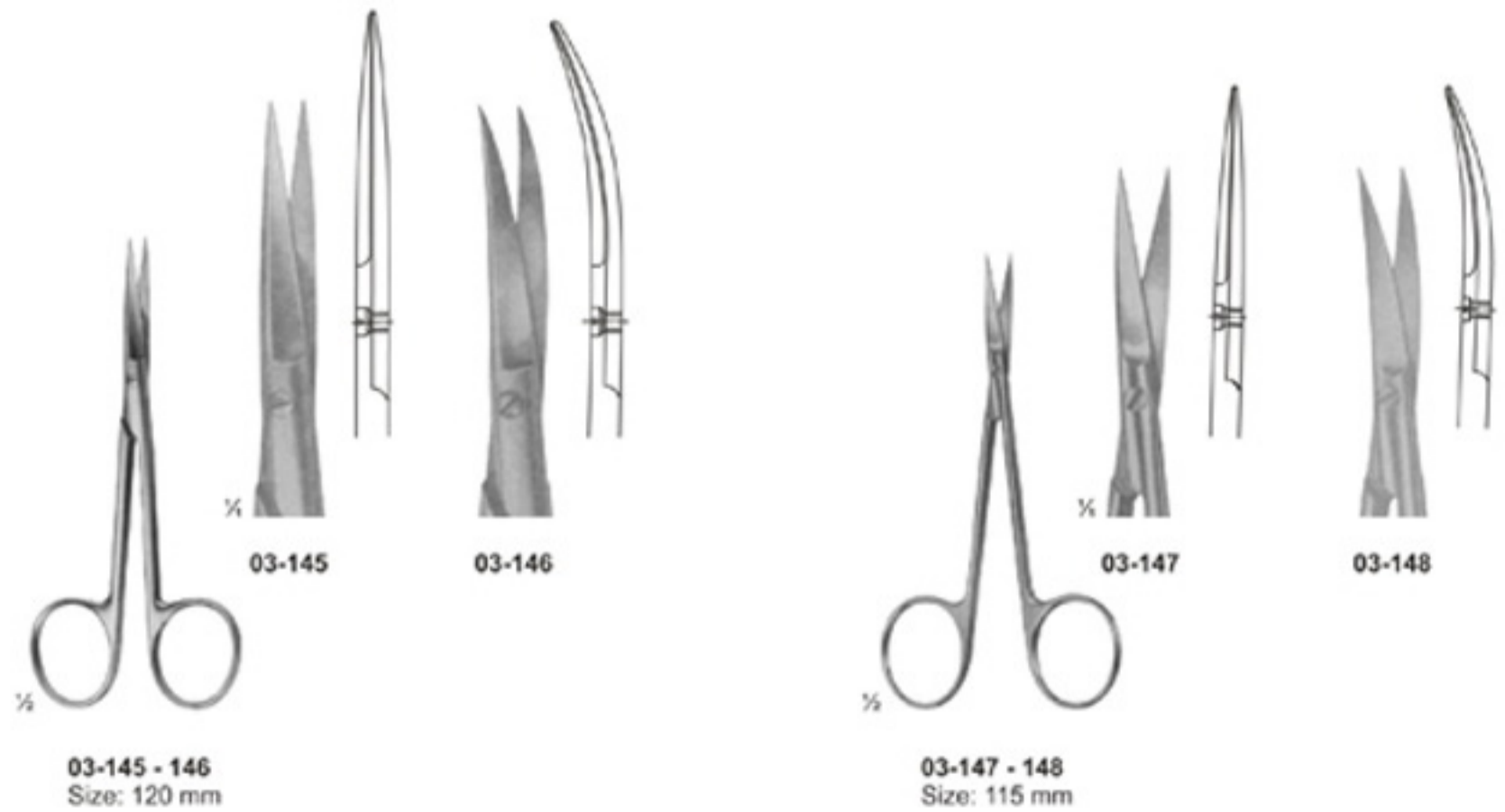
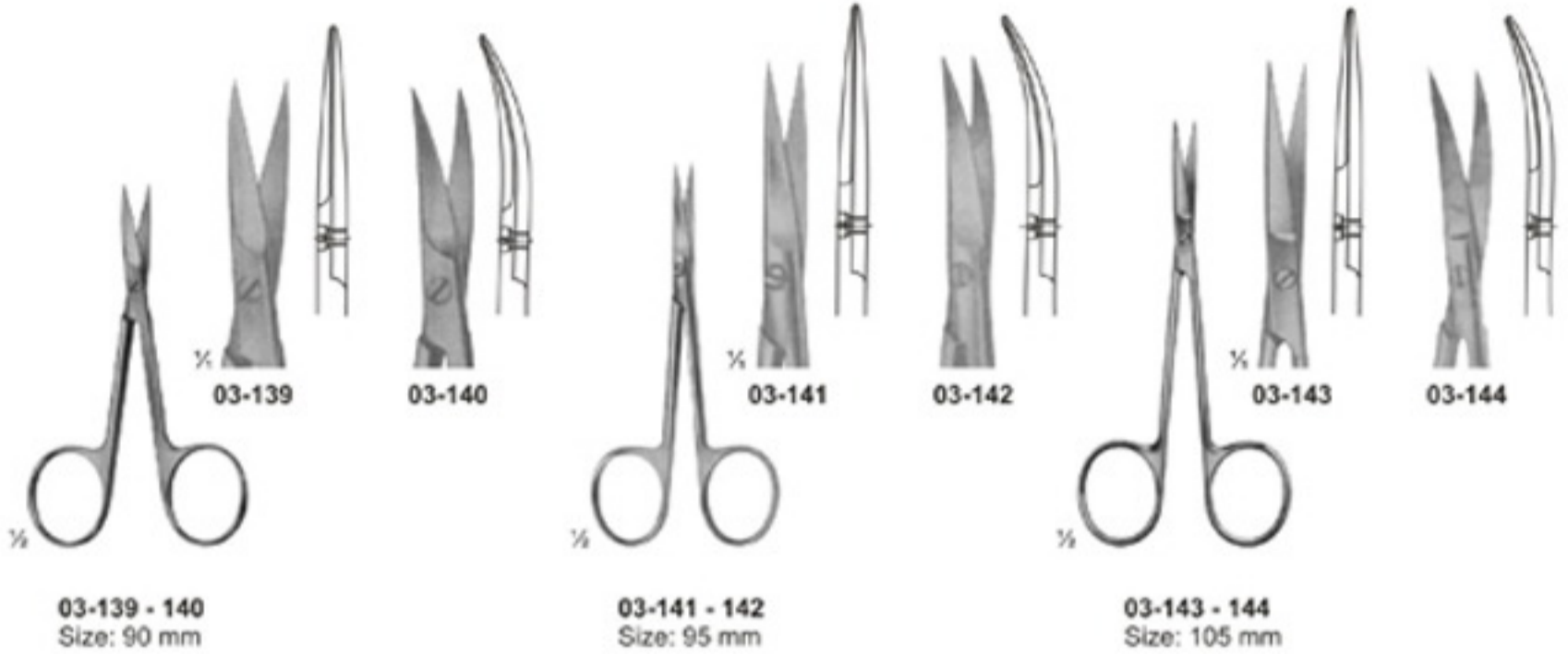



03-149 - 151
Size: 120 mm



03-149



03-150



03-151



03-152 - 155
Size: 130 mm



03-152



03-153

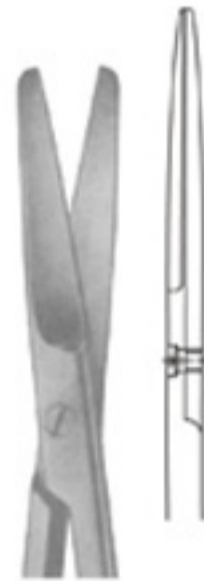

03-154



03-155

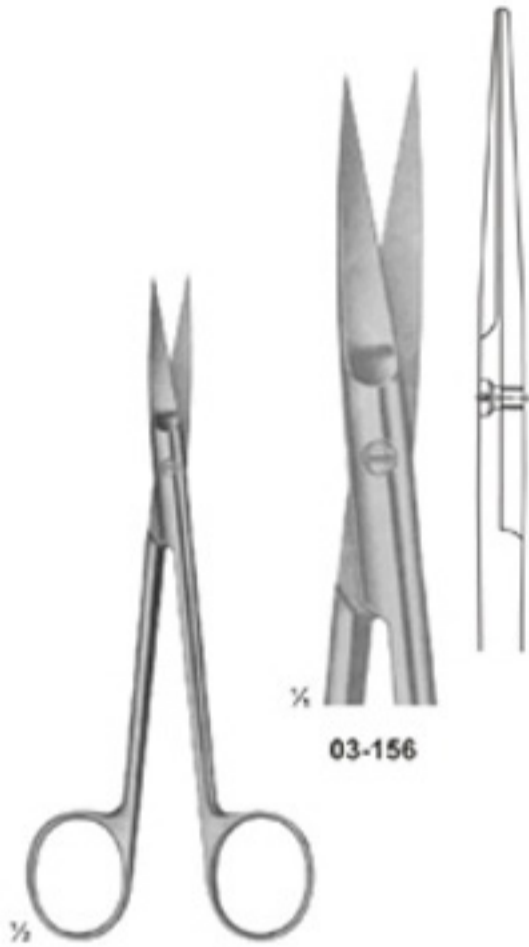

03-156



03-157

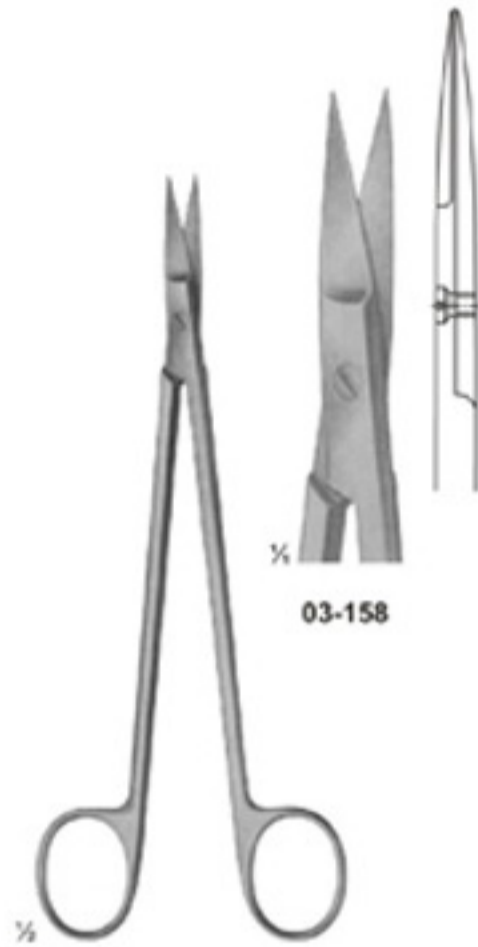

03-158

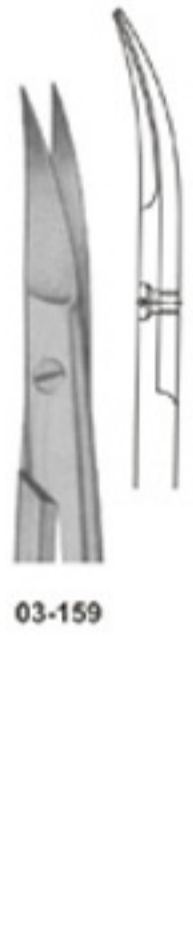

03-159

03-156 - 157
JOSEPH
Size: 150 mm

03-158 - 159
KELLY
Size: 175 mm



03-160
QUINBY
Size: 130 mm

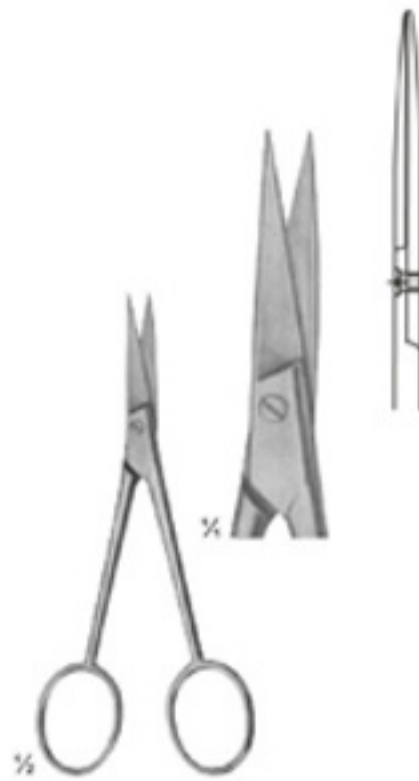

03-161
Size: 110 mm



03-162 - 170 (Standard Types)
03-162 (105 mm)
03-163 (115 mm)
03-164 (130 mm)
03-165 (145 mm)
03-166 (150 mm)
03-167 (165 mm)
03-168 (175 mm)
03-169 (185 mm)
03-170 (200 mm)



03-171 - 177 (Standard Types)
03-171 (115 mm)
03-172 (130 mm)
03-173 (145 mm)
03-174 (150 mm)
03-175 (165 mm)
03-176 (175 mm)
03-177 (185 mm)

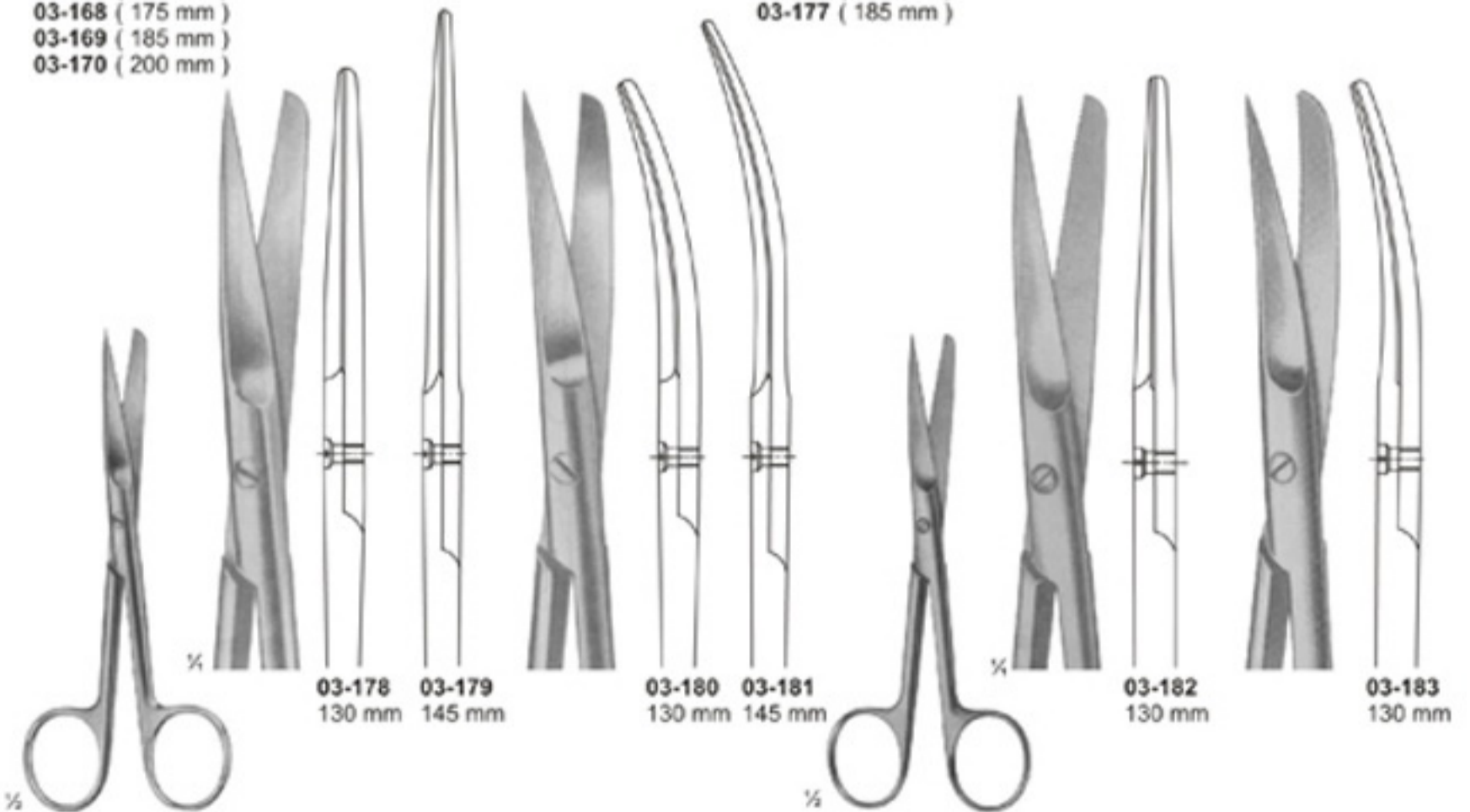

03-178 - 181
 Slender Types

03-182 - 183
 For Wound Edges
 1 Blade Serrated

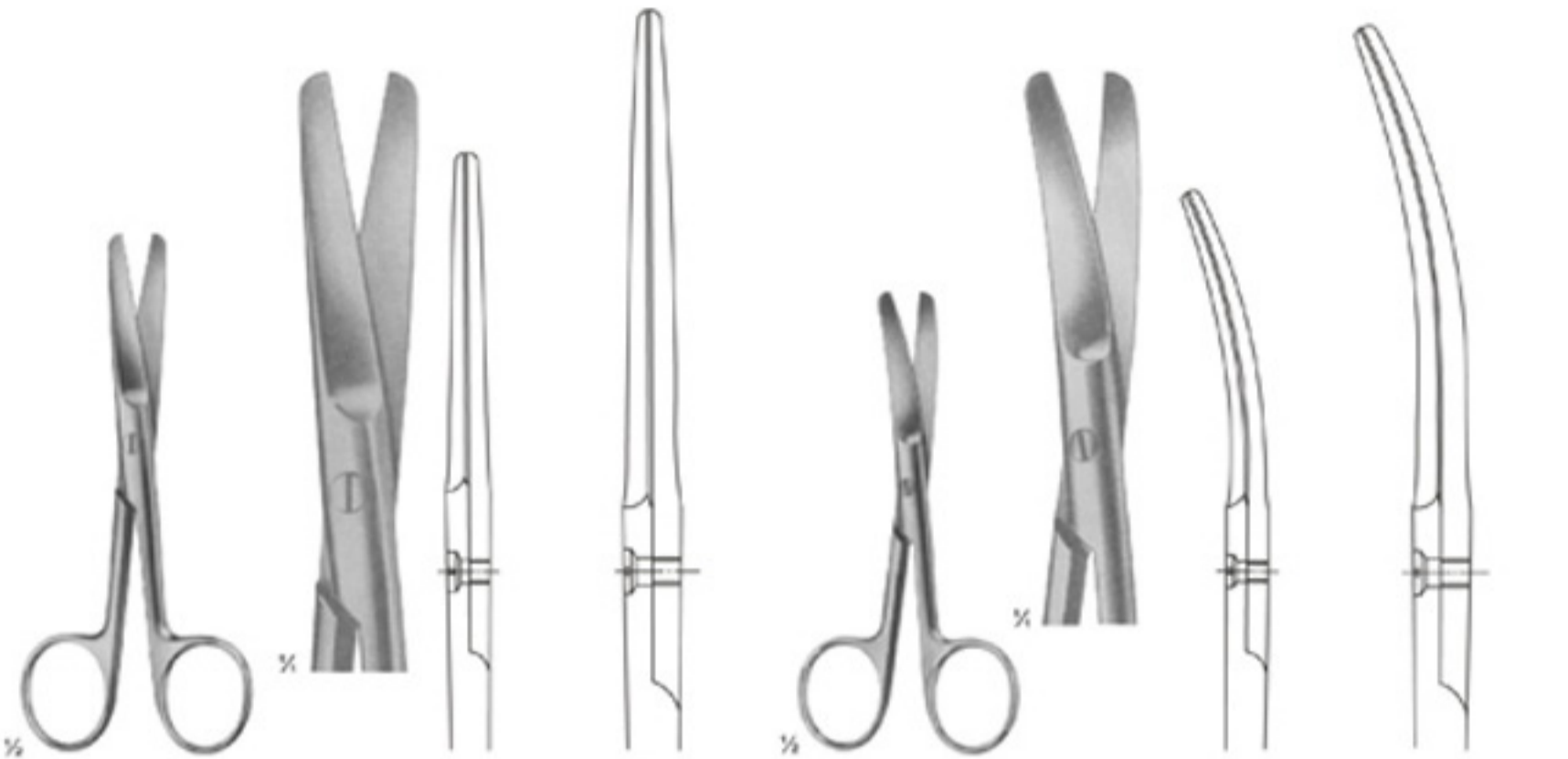

03-184 - 188 (Standard Types)
 03-184 (130 mm)
 03-185 (145 mm)
 03-186 (150 mm)
 03-187 (165 mm)
 03-188 (175 mm)

03-184 Size: 130 mm
03-188 Size: 175 mm

03-189 - 194 - COOPER
 Standard Types
 03-189 (115 mm)
 03-190 (130 mm)
 03-191 (145 mm)
 03-192 (150 mm)
 03-193 (165 mm)
 03-194 (175 mm)

03-189 Size: 115 mm
03-194 Size: 175 mm

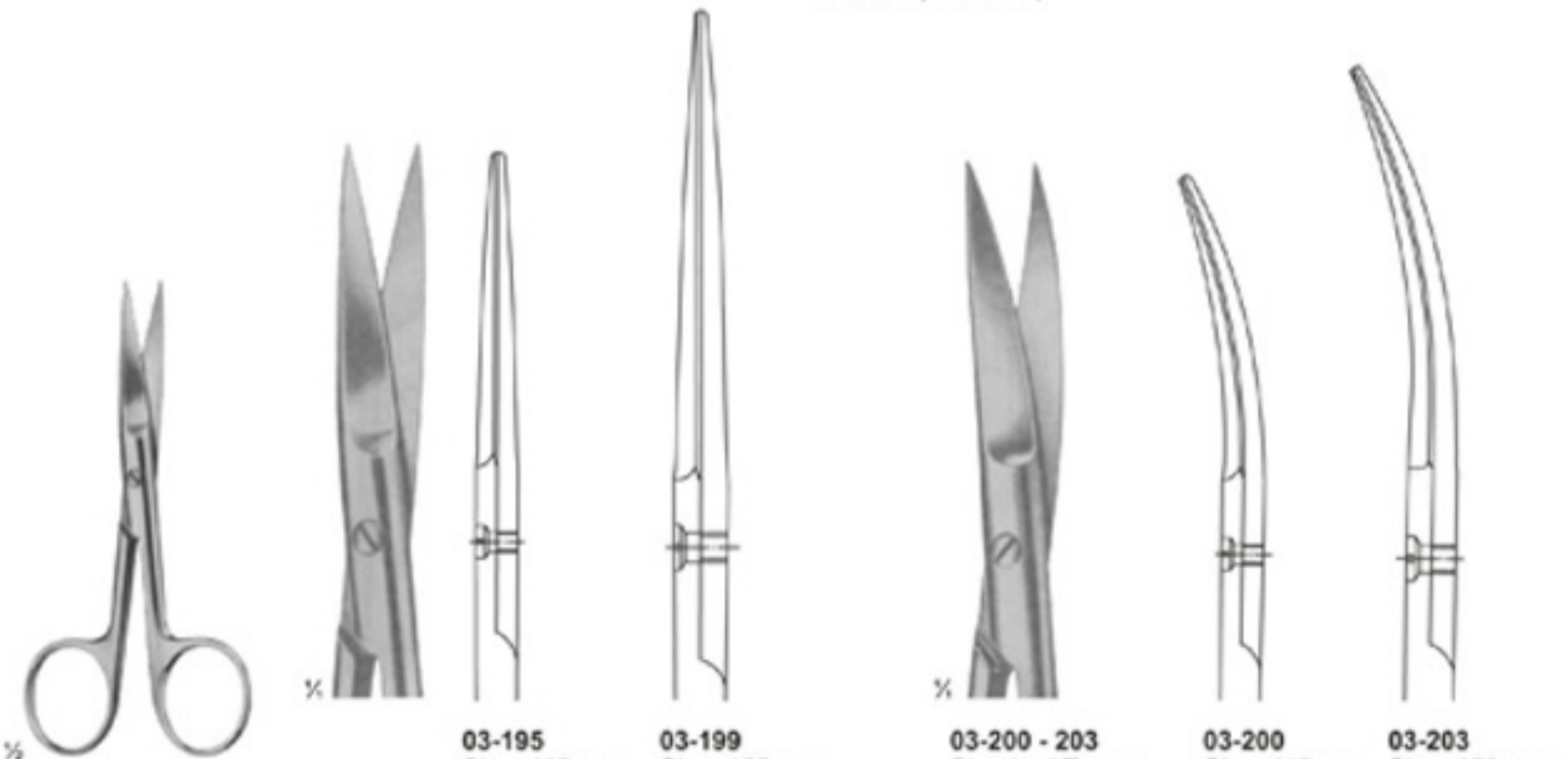

03-195 - 199
 Standard Types
 03-195 (115 mm)
 03-196 (130 mm)
 03-197 (145 mm)
 03-198 (150 mm)
 03-199 (165 mm)

03-195 Size: 115 mm
03-199 Size: 165 mm

03-200 - 203
 Standard Types
 03-200 (115 mm)
 03-201 (130 mm)
 03-202 (145 mm)
 03-203 (150 mm)

03-200 Size: 115 mm
03-203 Size: 150 mm



03-204 - 206
DEAVER
With flat lock

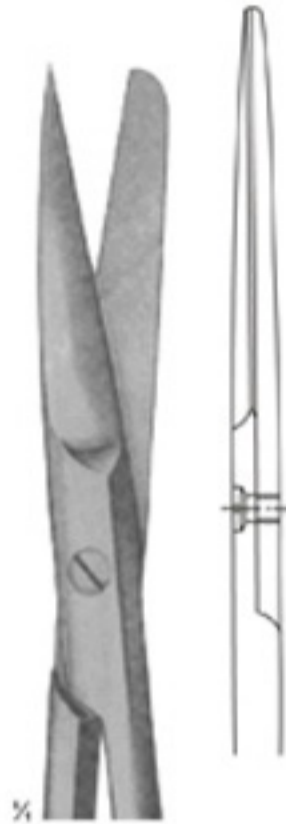

03-204
Size: 145 mm

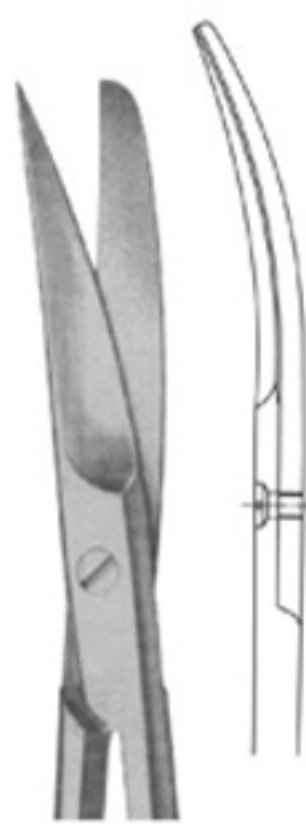

03-205
Size: 145 mm

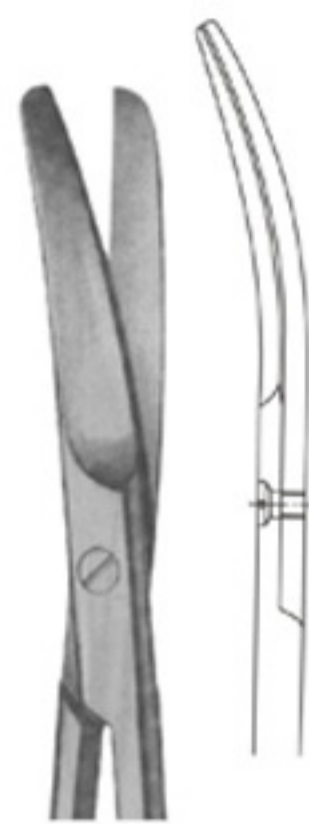

03-206
Size: 145 mm



03-207 - 209
Incision Scissors



03-207
Size: 130 mm



03-208
Size: 145 mm



03-209
Size: 165 mm



03-210
SYSTRUNK
Nail Splitting Scissors



03-210
Size: 130 mm

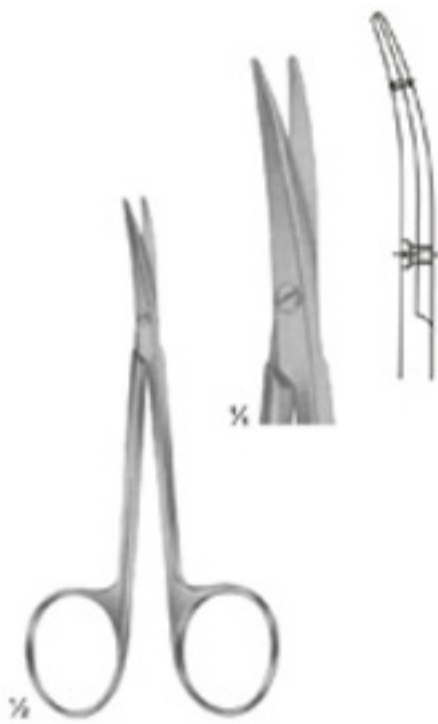

03-211
LITTLER
Dissecting Scissors
Tips with eye for suture
Size: 115 mm

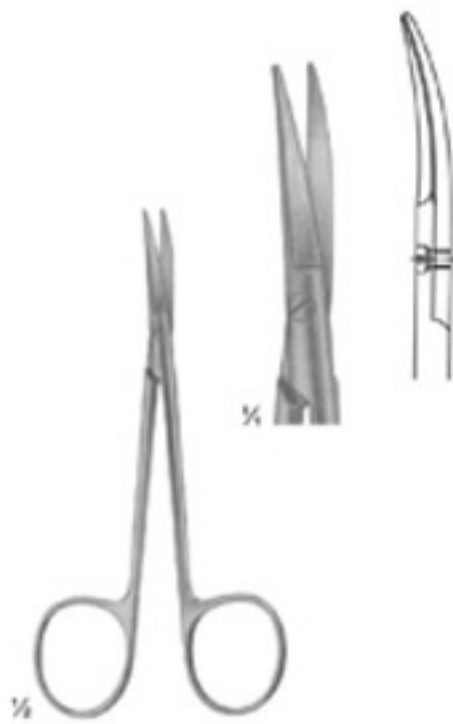

03-212
COTTLE
Bulldog Scissors
Size: 115 mm



03-213 **03-214**
Size: 100 mm Size: 100 mm

03-213 - 214
STEVENS
Vessel and tendon Scissors
Size: 100 mm



03-215
STEVENS
Fine Dissecting Scissors
Size: 110 mm

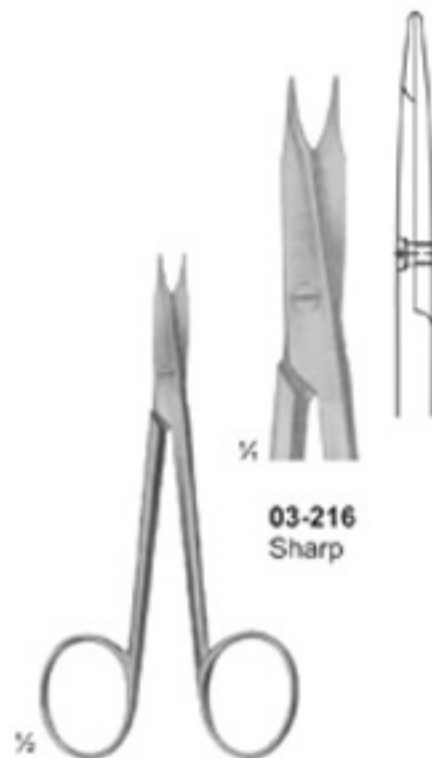

03-216 - 219
STEVENS
Vessel and tendon Scissors
Size: 110 mm

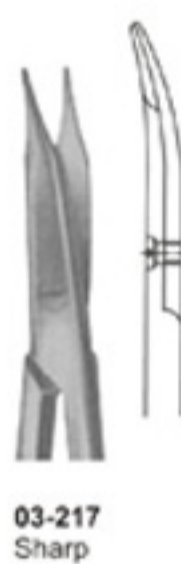

03-217
Sharp



03-218
Blunt

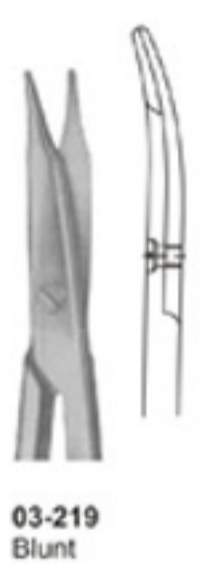

03-219
Blunt

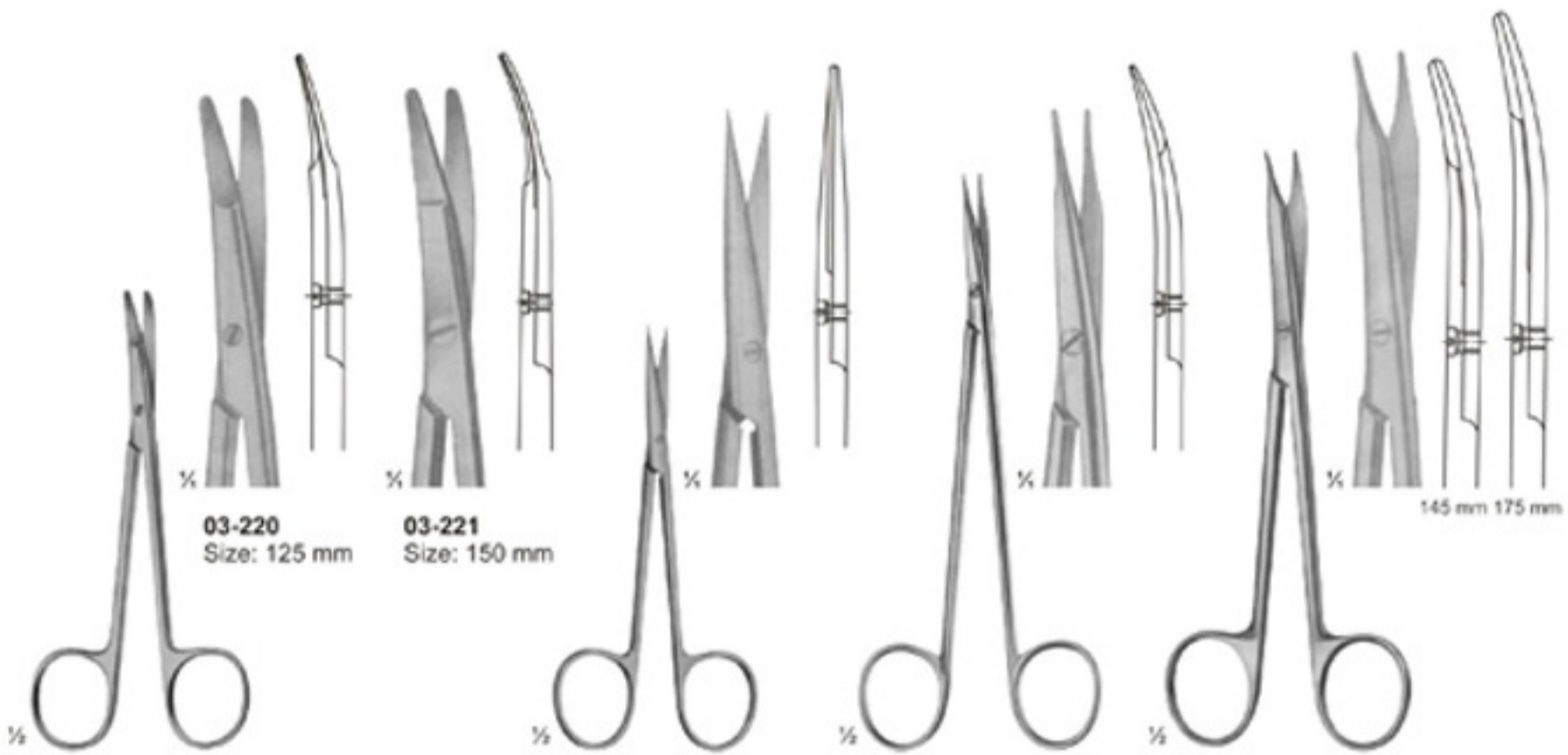

03-220 - 221
KILNER
 Special flat points for dissecting and undermining the skin

03-222
KILNER
 Fine dissecting scissors
 Size: 115 mm

03-223
JAMESON
 Dissecting scissors
 Size: 150 mm

03-224
REYNOLDS
 Dissecting scissors
 Size: 145 - 175 mm



03-225
DE BAKEY
 Ateriotomy scissors
 Size: 175 mm

03-226 - 227
TOENNIS ADSON
 Dissecting scissors
 Size: 175 mm

03-228 - 230
TOENNIS
 Dissecting scissors
 Size: 150 mm

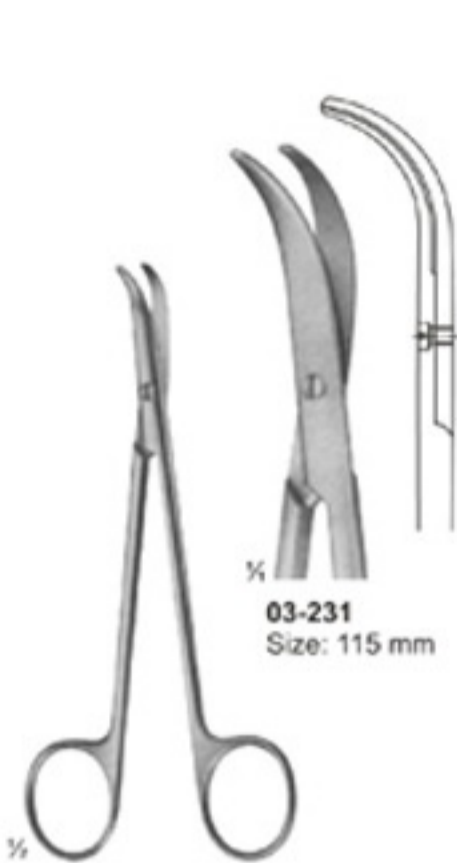

03-231
Size: 115 mm

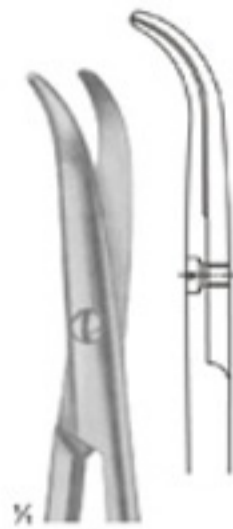

03-232
Size: 135 mm

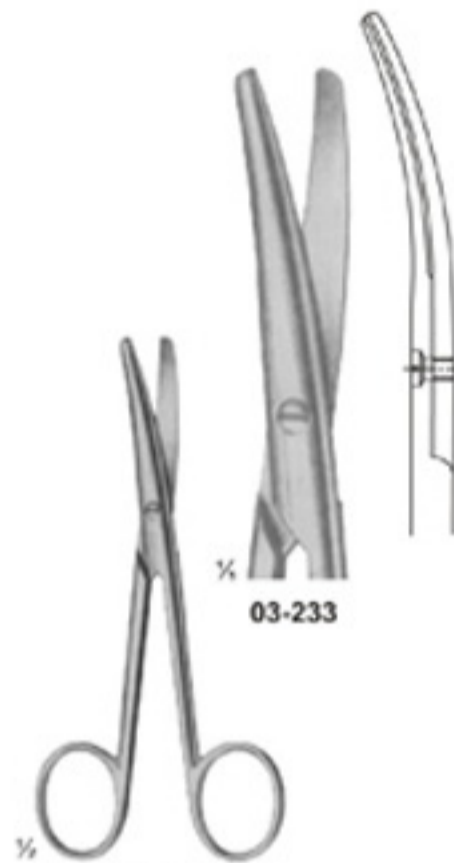

03-233

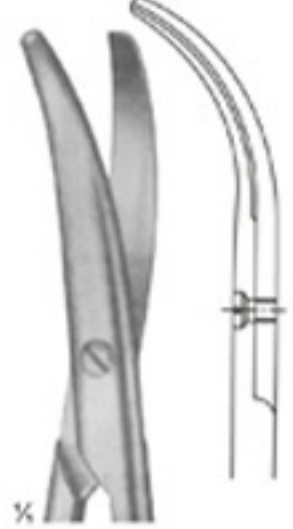

03-234

03-231 - 232
FOMON
Lower lateral scissors

03-233 - 234
LANDOLT
Enucleation scissors
Size: 120 mm

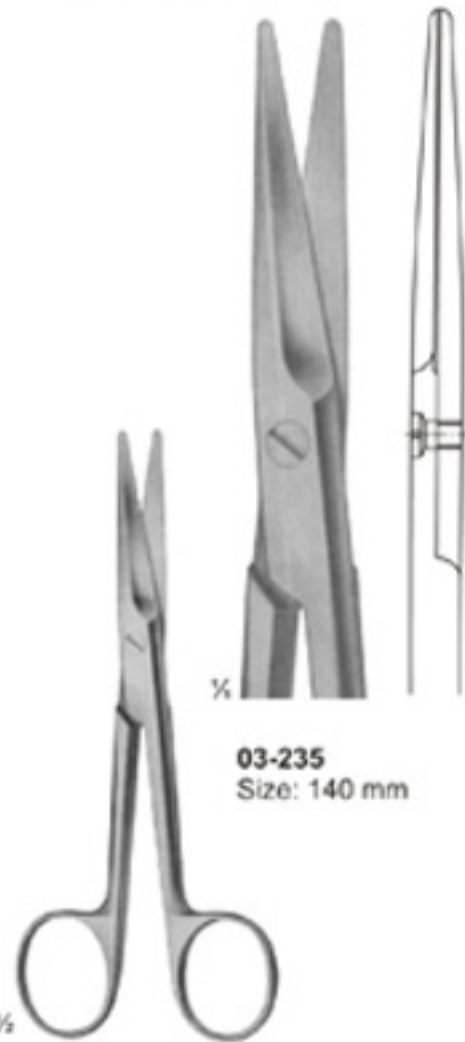

03-235
Size: 140 mm

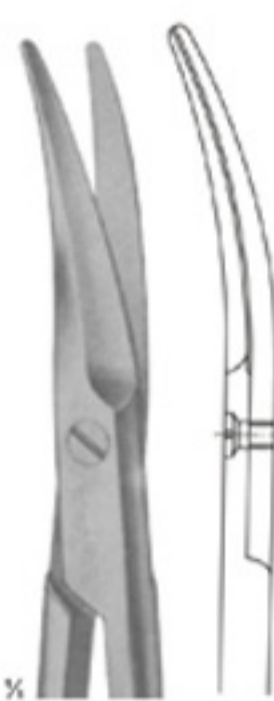

03-238 - 240
MAYO
03-238 (140 mm)
03-239 (155 mm)
03-240 (170 mm)

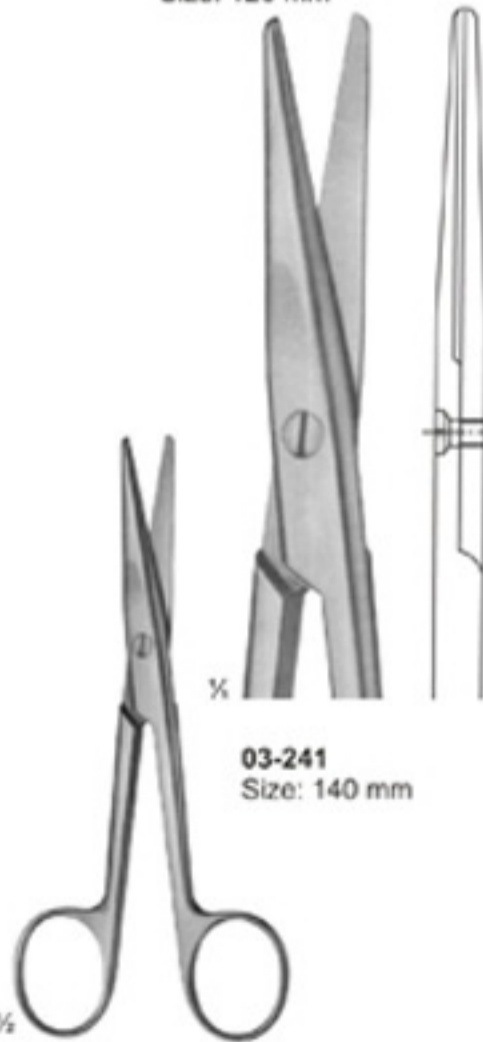

03-241
Size: 140 mm



03-243 - 244
MAYO-STILLE
03-243 (140 mm)
03-244 (170 mm)

03-235 - 237
MAYO
03-235 (140 mm)
03-236 (155 mm)
03-237 (170 mm)

03-241 - 242
MAYO-STILLE
03-241 (140 mm)
03-242 (170 mm)

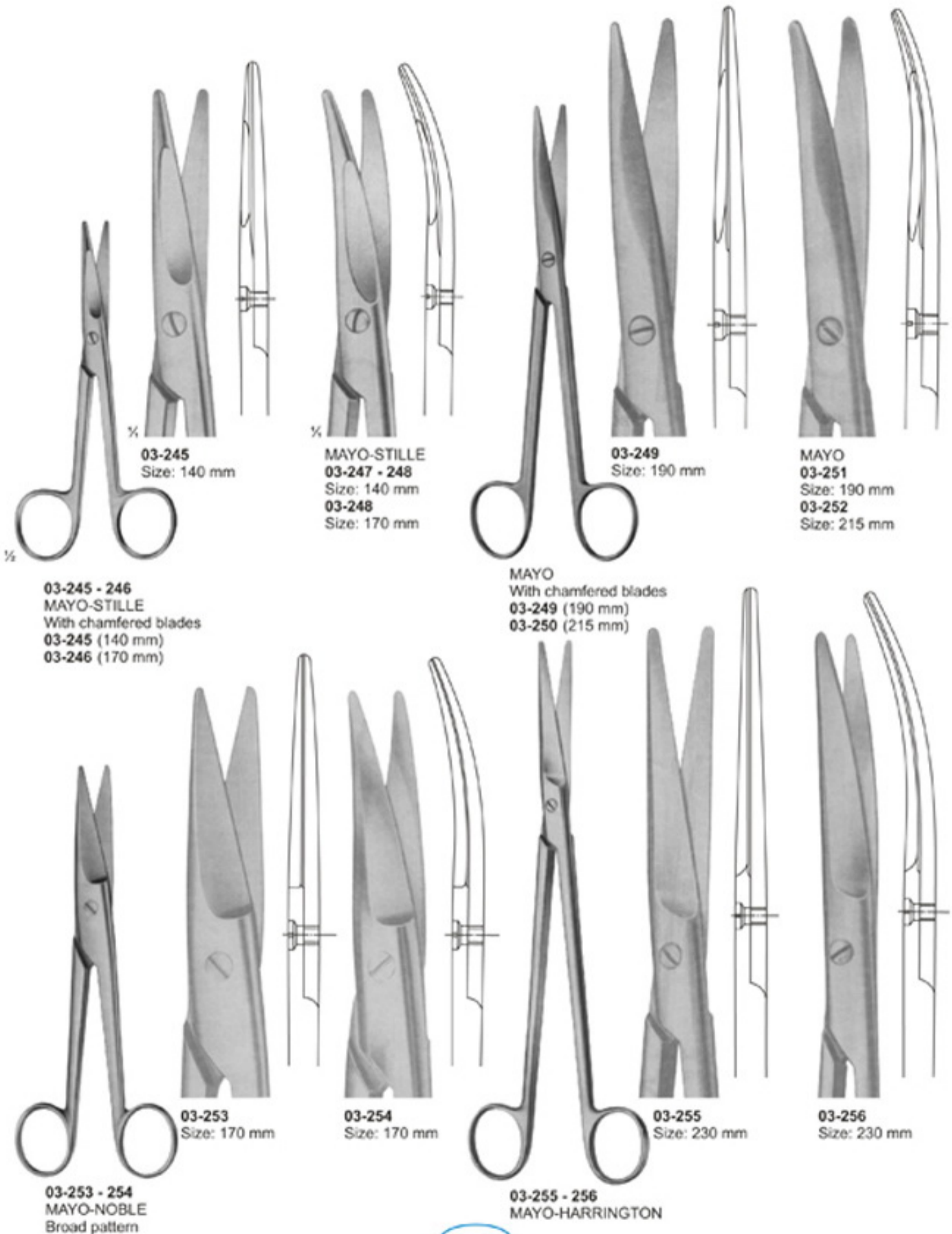

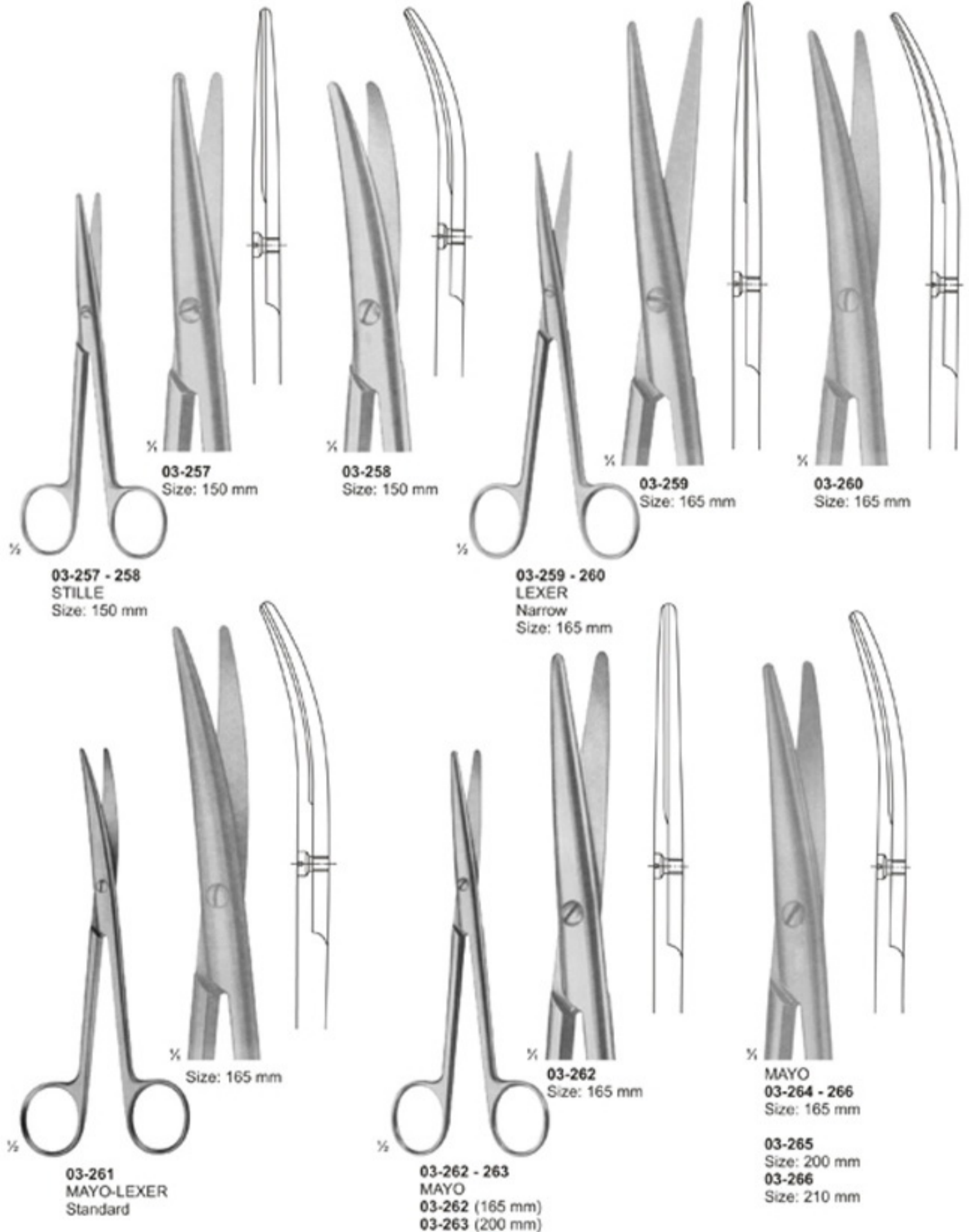

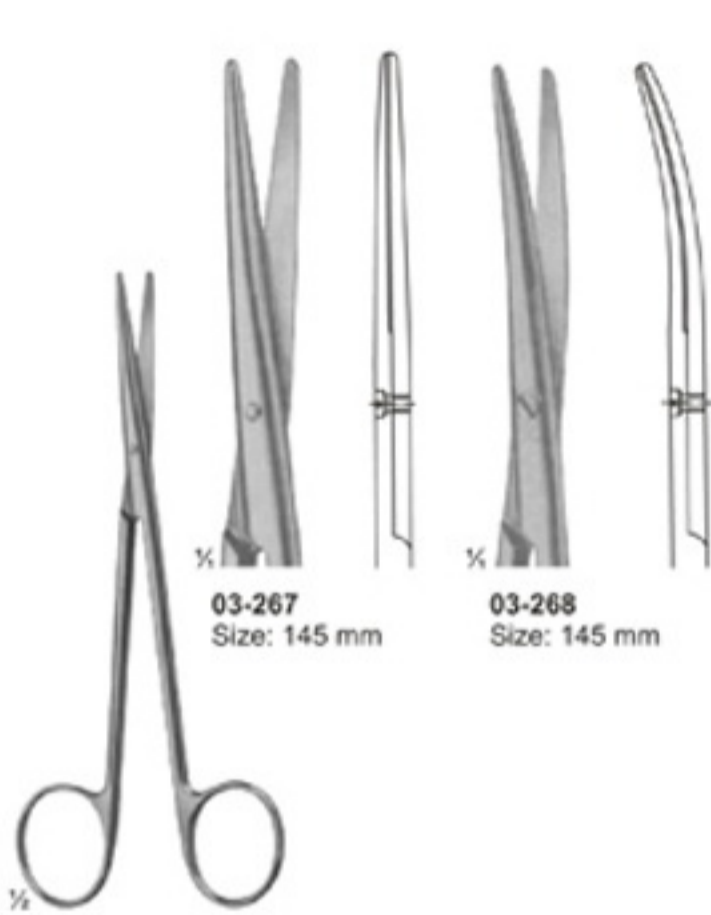

03-267
Size: 145 mm

03-268
Size: 145 mm

03-267 - 268
BABY - METZENBAUM



03-269 145 mm
03-270 180 mm
03-271 200 mm

03-272 145 mm
03-273 180 mm
03-274 200 mm

03-269 - 274
METZENBAUM



03-275 - 282
NELSON - METZENBAUM

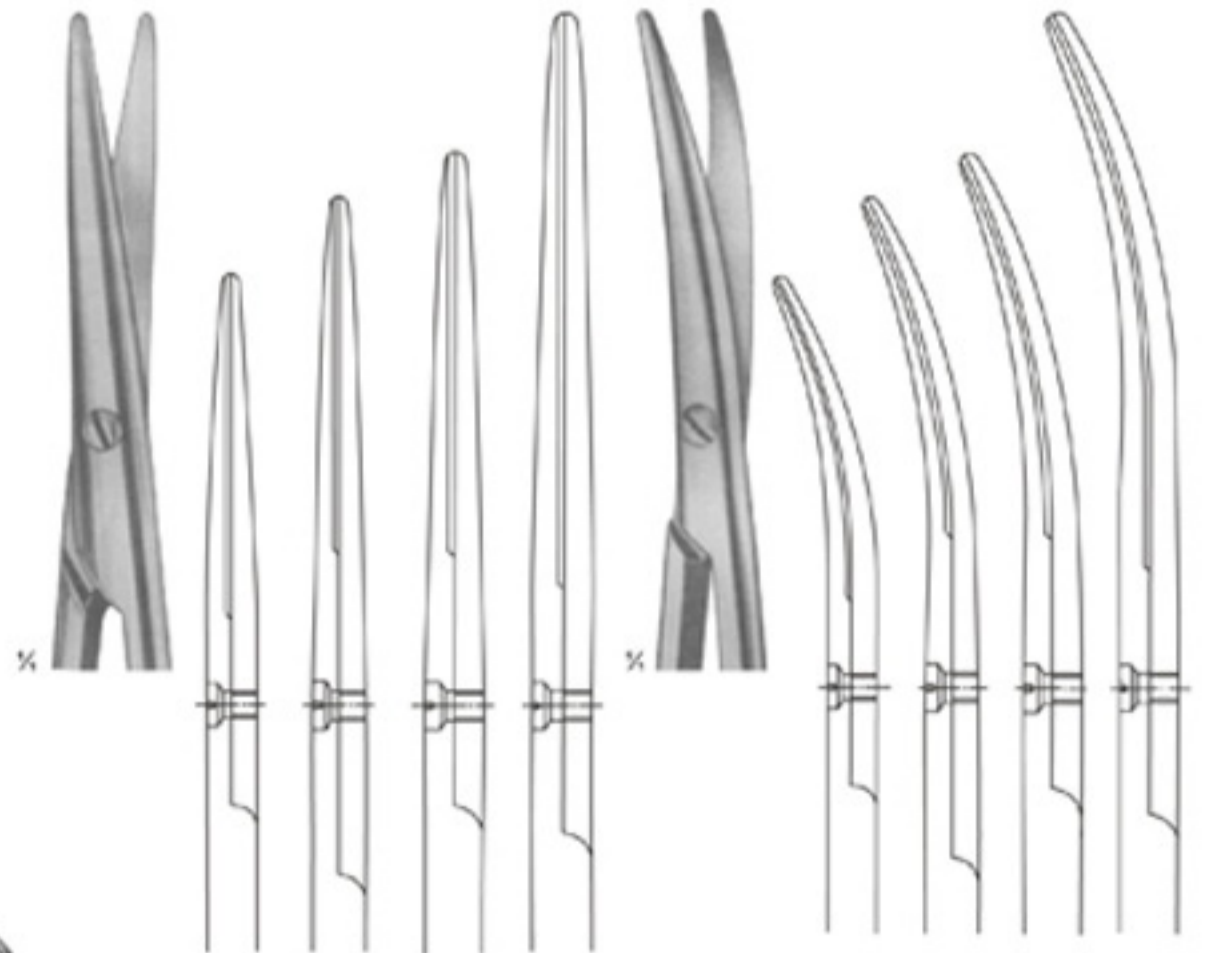

03-275 230 mm
03-276 250 mm
03-277 280 mm
03-278 305 mm

03-279 230 mm
03-280 250 mm
03-281 280 mm
03-282 305 mm

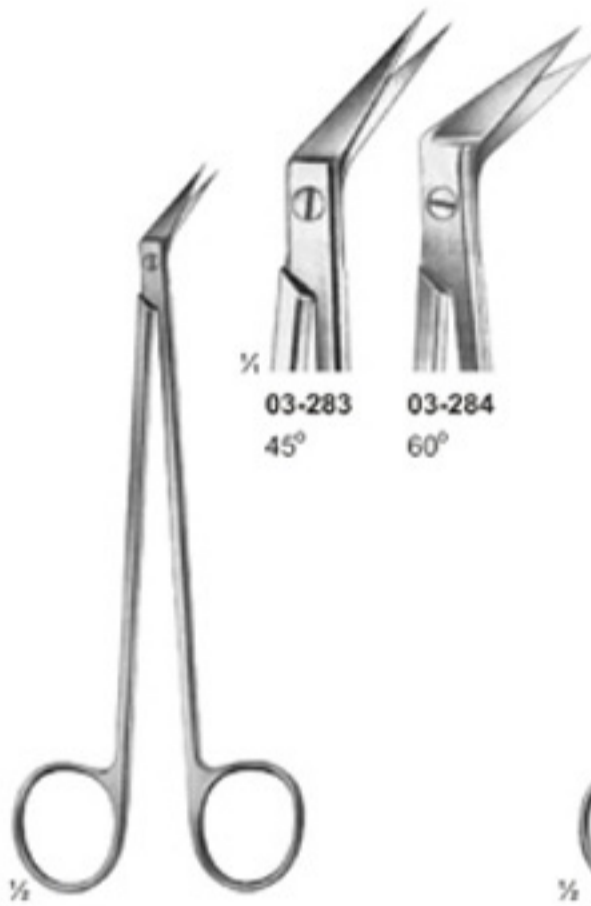

03-283
45°

03-284
60°

03-283 - 284
DE BAKY
Size: 155 mm

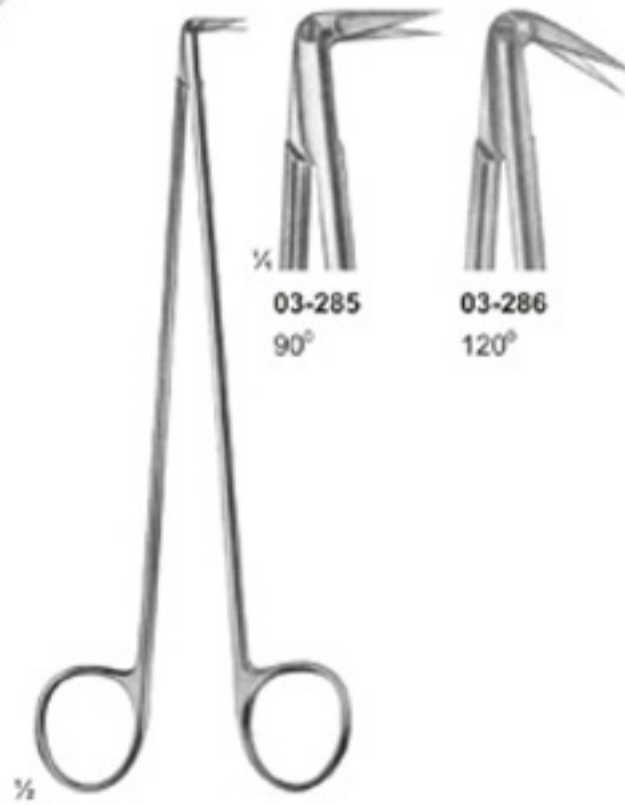

03-285
90°

03-286
120°

03-285 - 286
DIETRICH
Size: 170 mm

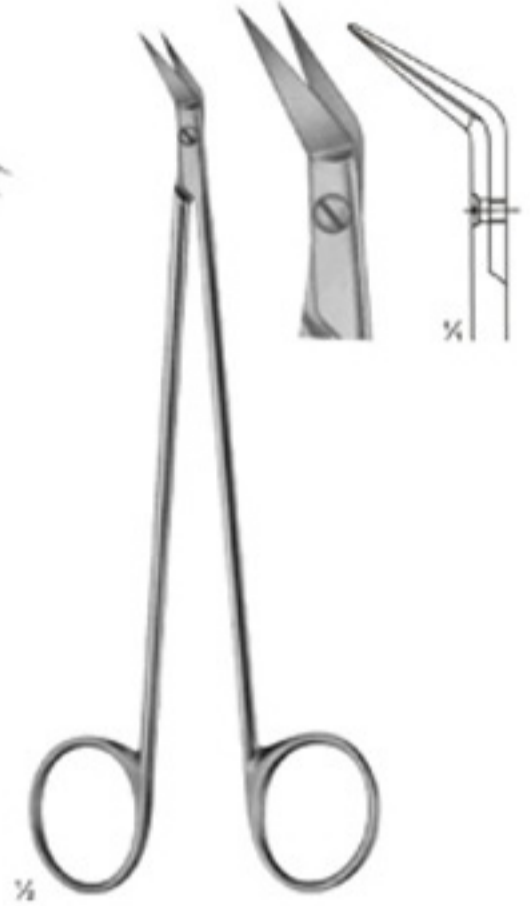

03-287
POTTS-SMITH
Size: 180 mm

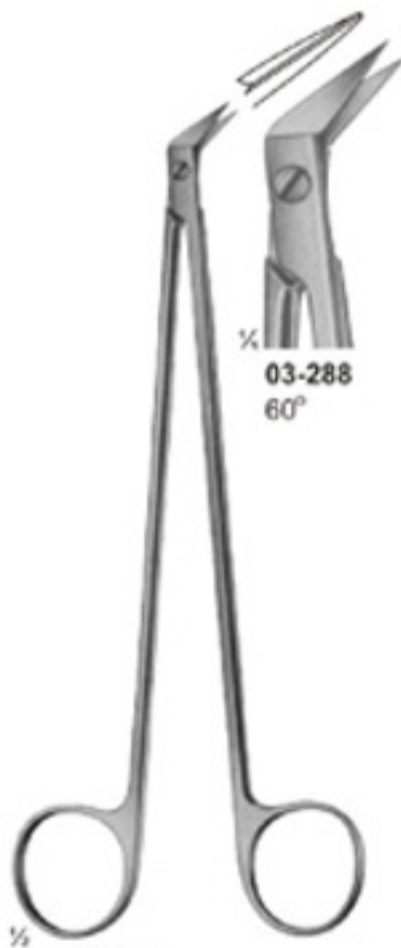

03-288
60°

03-288
POTTS-SMITH
Size: 180 mm

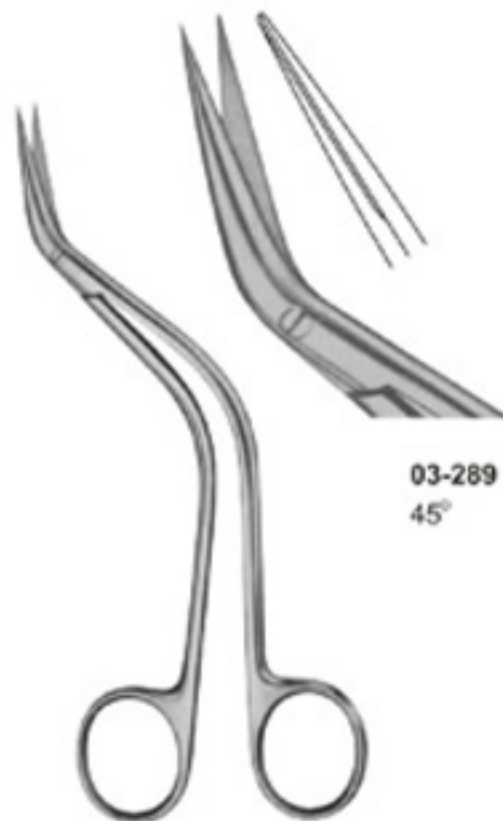

03-289
45°

03-289
DEBAKEY
Size: 155 mm



03-290
55°

03-290
FAVOLORO
Size: 140 mm



03-297
1 Finely Toothed Blade
Size: 130 mm

03-298
LOCKLIN
Curved Sideways,
1 Toothed Blade
Size: 155 mm

03-299
FOMON
Blades Serrated
Size: 145 mm

03-300
COTTLE
Size: 165 mm

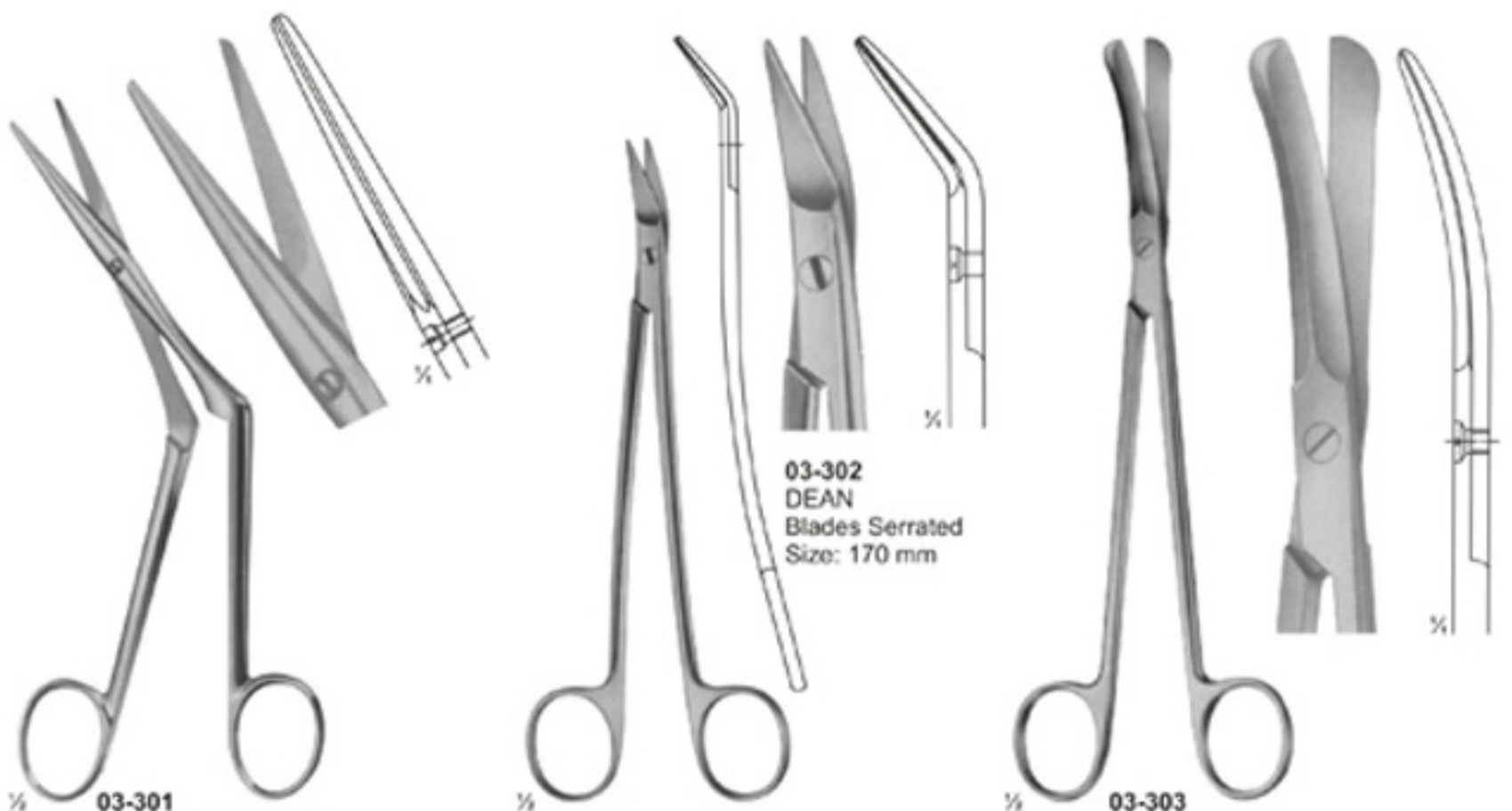

03-301
HEYMANN-KNIGHT
Size: 175 mm

03-302
DEAN
Blades Serrated
Size: 170 mm

03-303
GOOD
Size: 195 mm

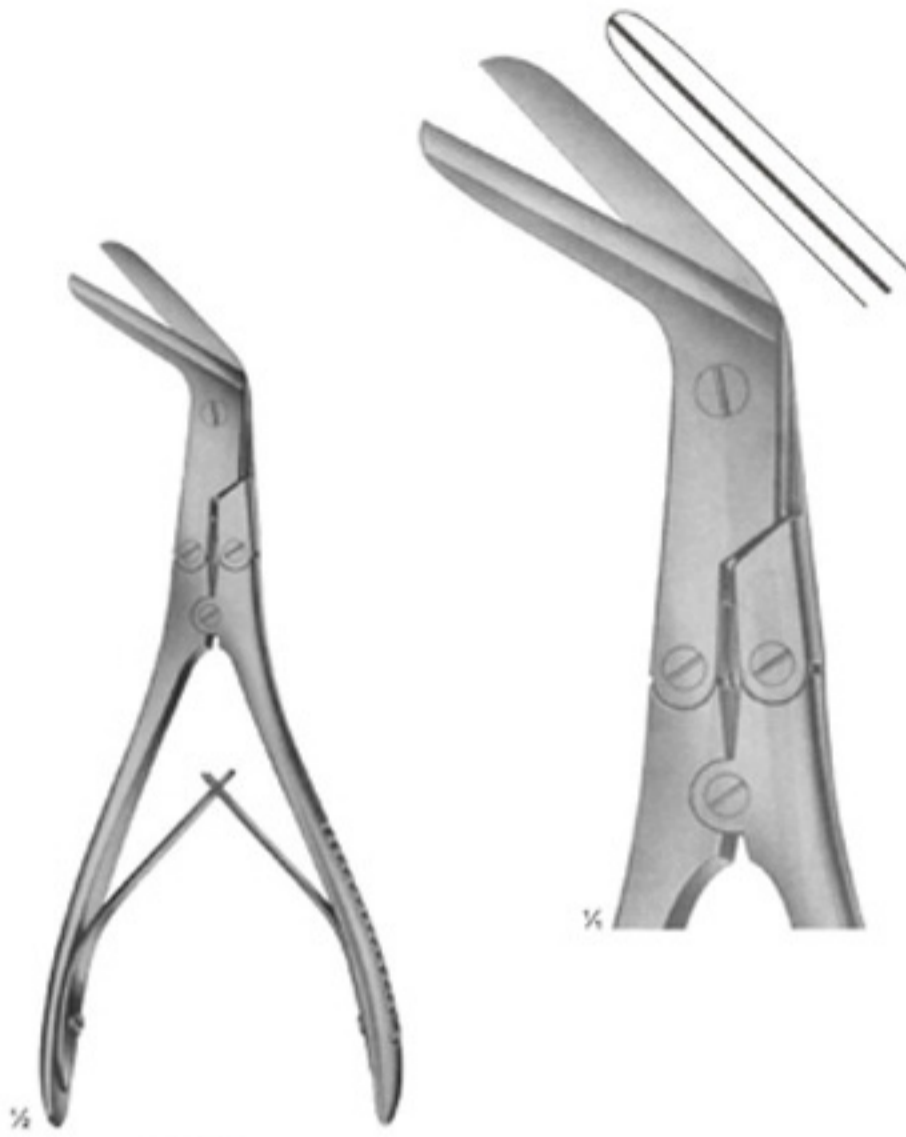

03-304
KILLIAN
Size: 200 mm



03-305 - 306



03-305
200 mm



1/2



03-306
200 mm



1/2

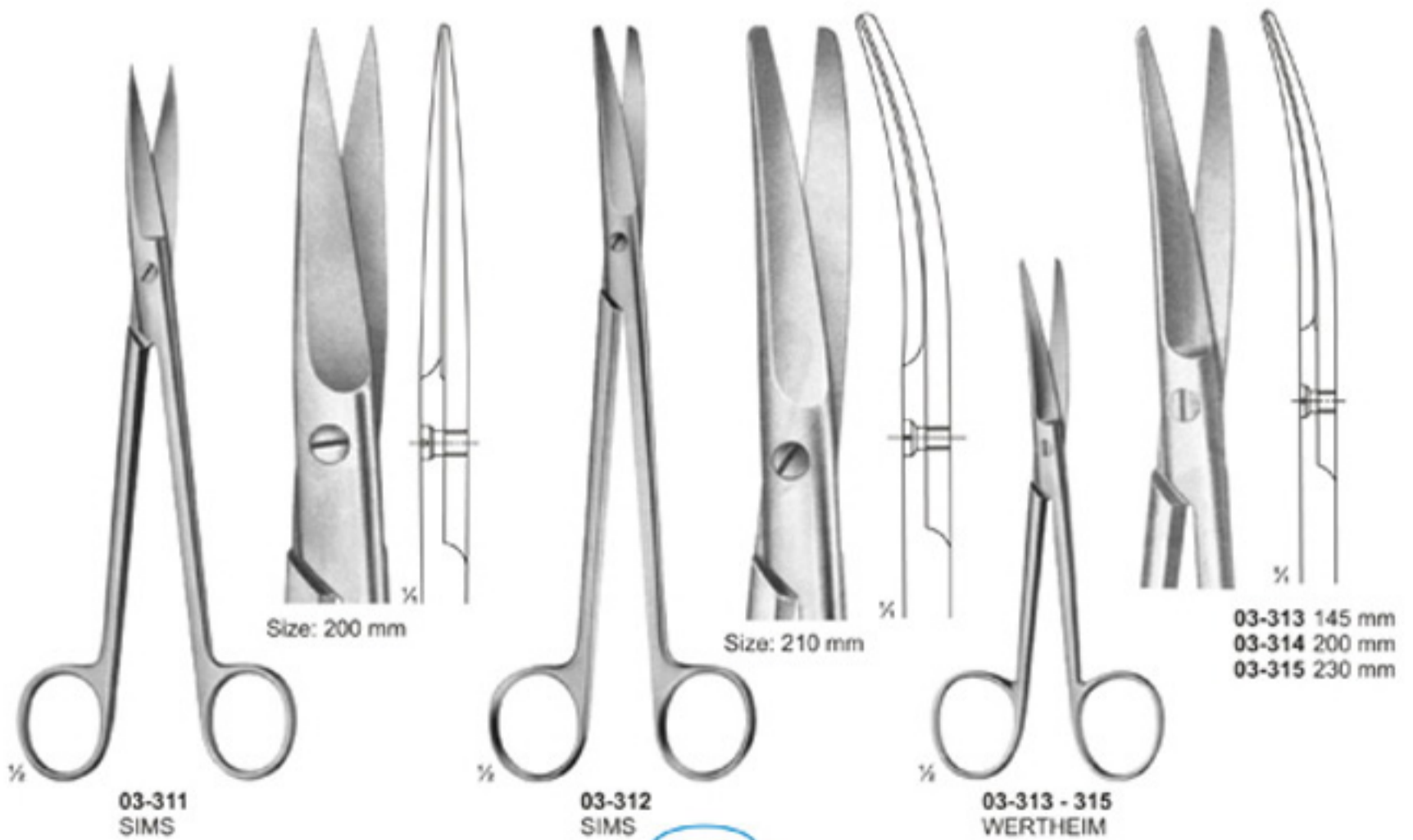
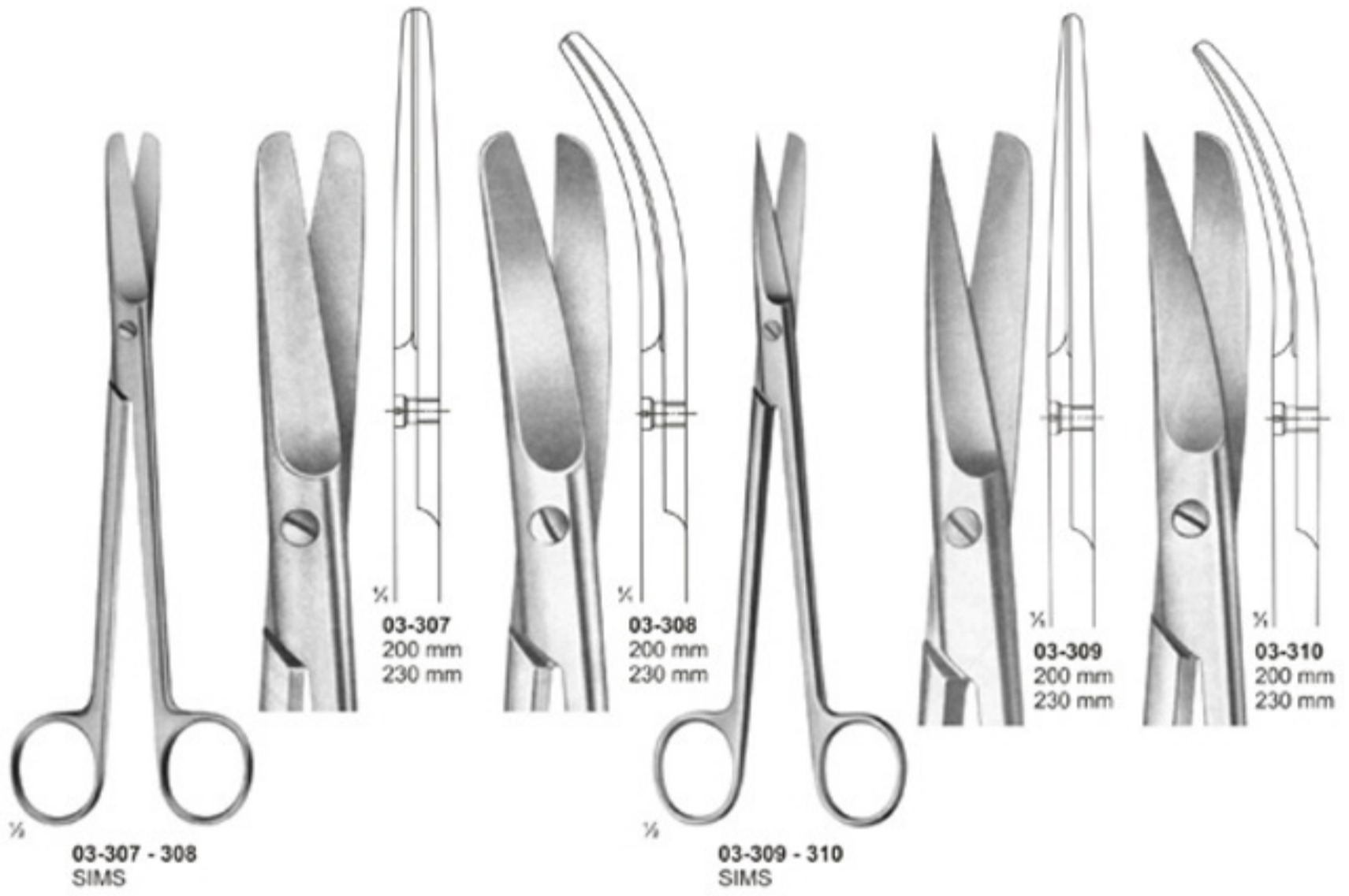

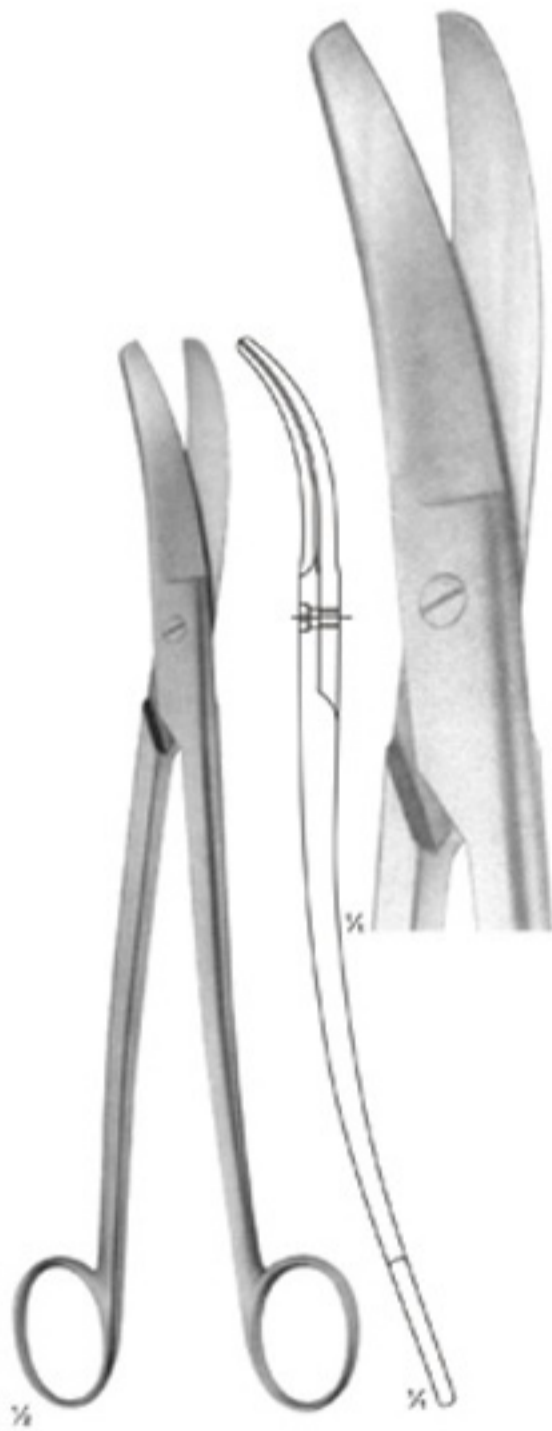

03-316
SIEBOLD
 Uterine Scissors
 Size: 245 mm

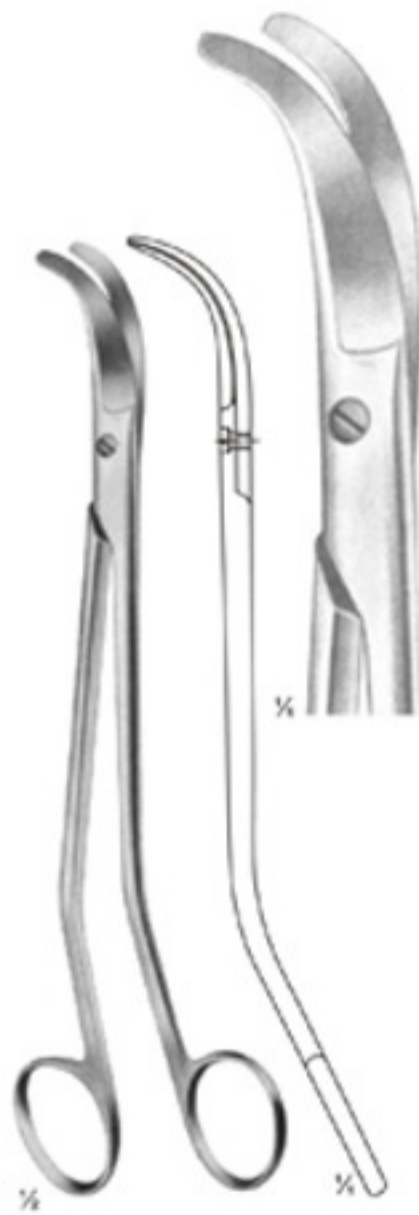

03-317
BOZEMANN
 Uterine Scissors
 Size: 220 mm

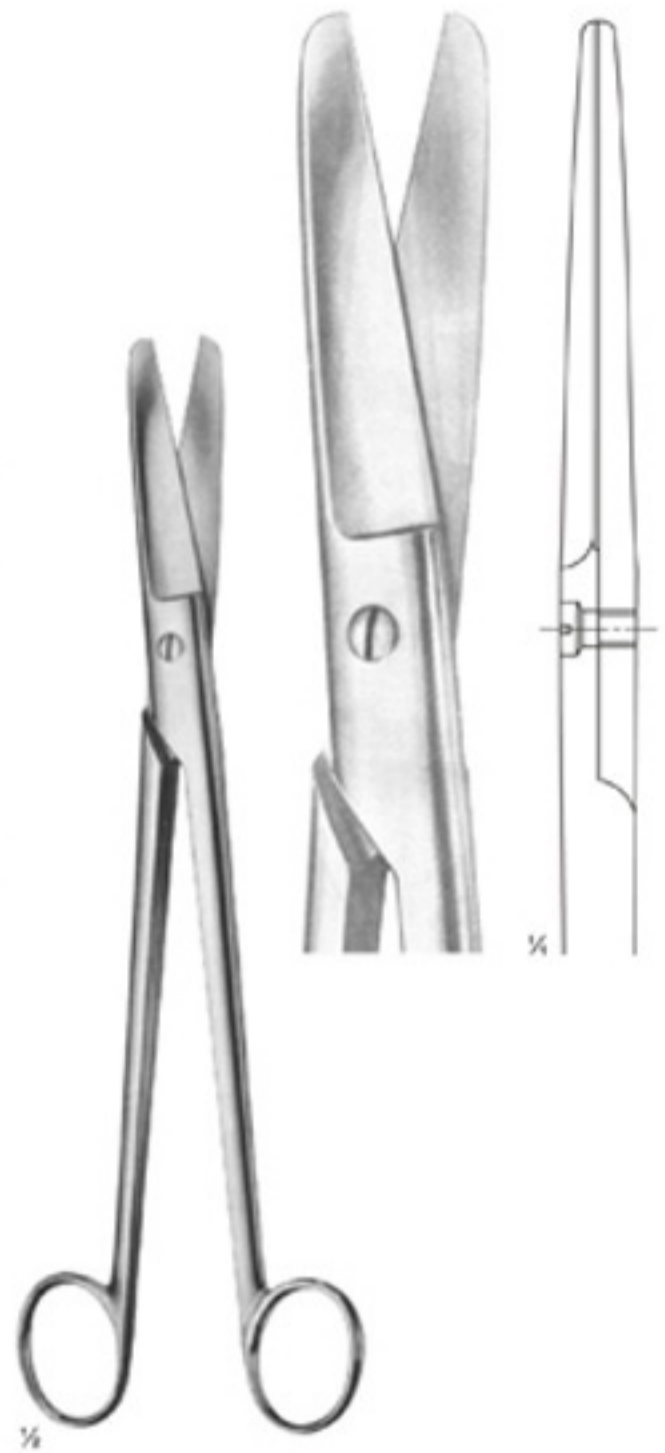

03-318
SIMS-SIEBOLD
 Uterine Scissors
 Size: 250 mm



03-319
SCHUMACHER
 Umbilical Cord Scissors
 Size: 155 mm



03-320
 Umbilical Cord Scissors
 Size: 105 mm

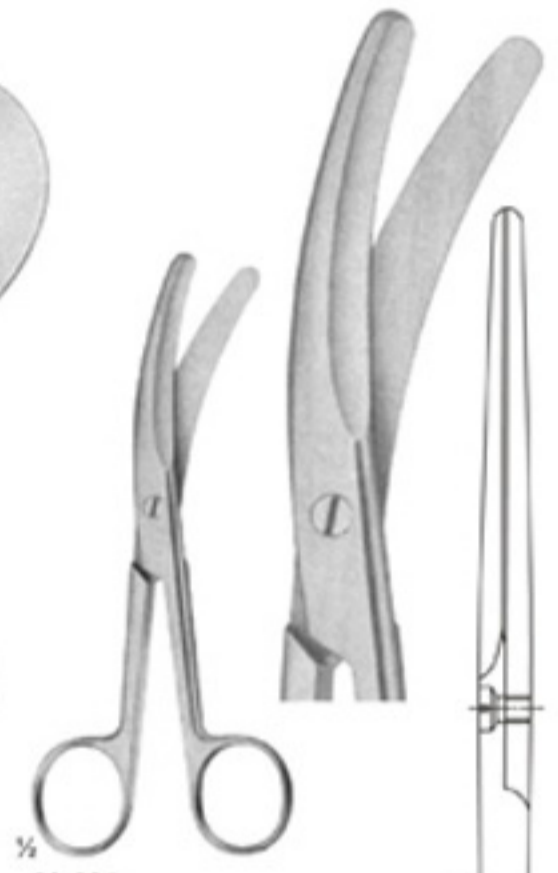

03-321
 Umbilical Cord Scissors

135 mm



03-322 - 323
BRAUN-STADLER
 Empisiotomy Scissors



03-322
 145 mm

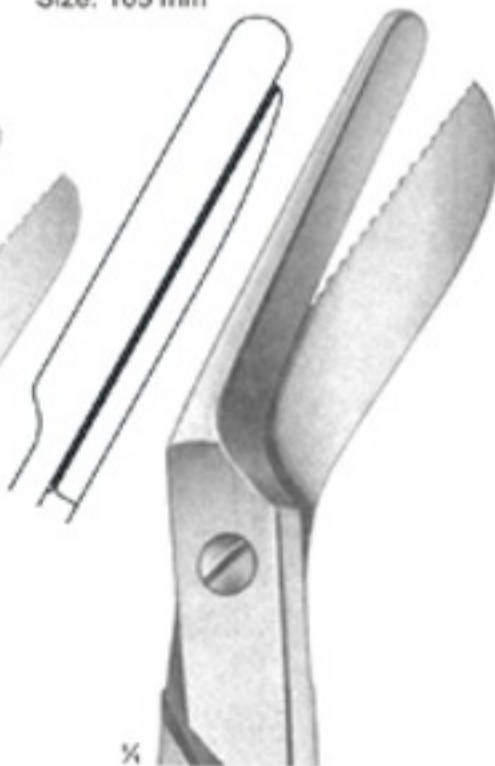

03-323
 200 mm



03-324
DAMMSCHERE
 Empisiotomy Scissors
 240 mm



1/2

03-334 - 338
BEEBE
Size: 110 mm

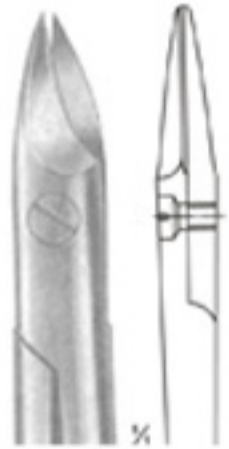

03-334



03-335

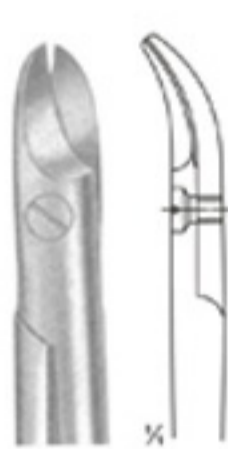

03-336
Broad Blades

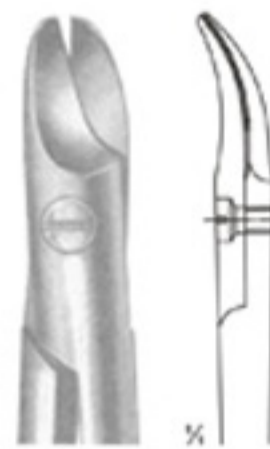

03-337
1 Blade Serrated

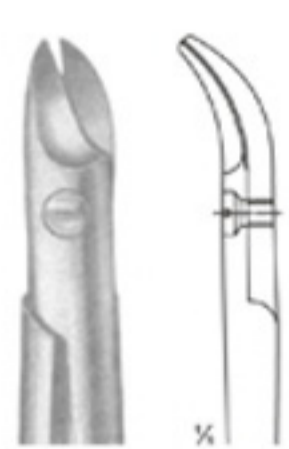

03-338
NAUJOKS
Strongly Curved

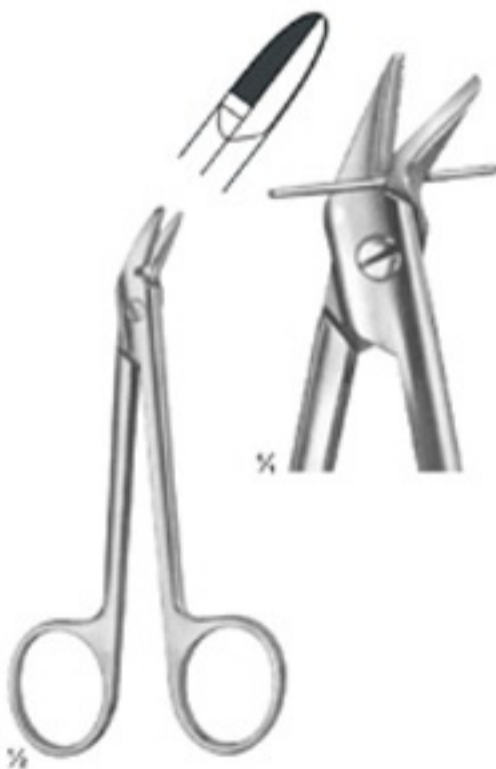

1/2

03-339
1 Blade Serrated
Size: 120 mm



1/2

03-340
STRACK
Size: 100 mm

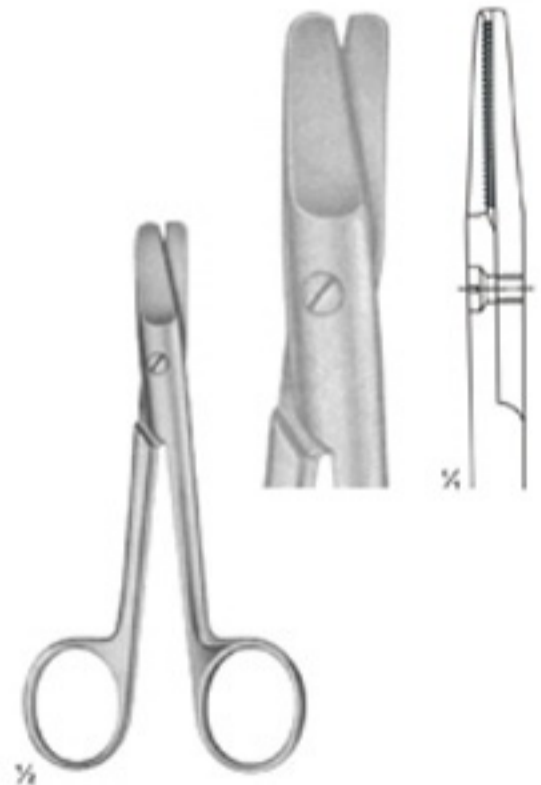

1/2

03-341
HARVEY
Size: 125 mm

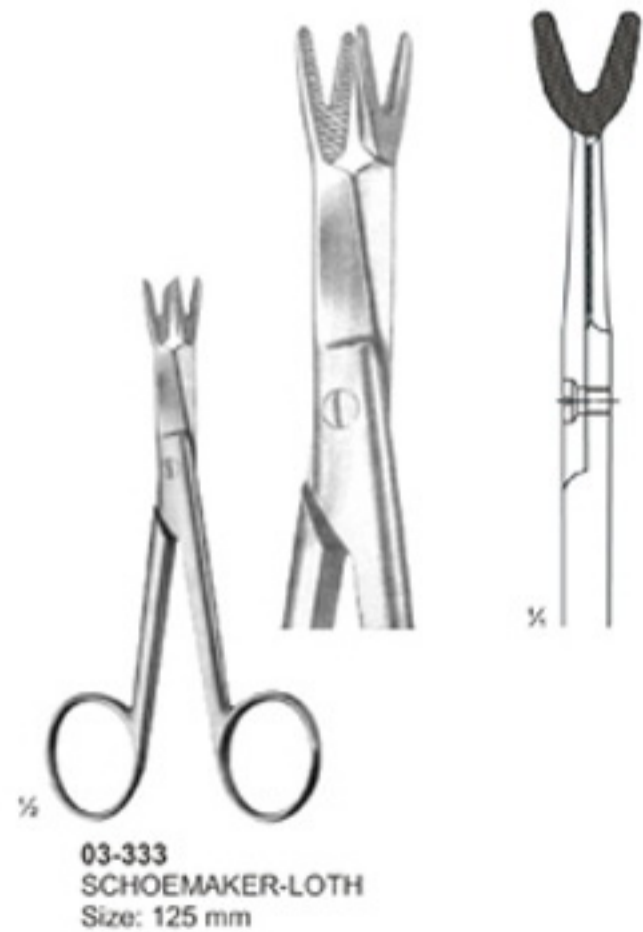
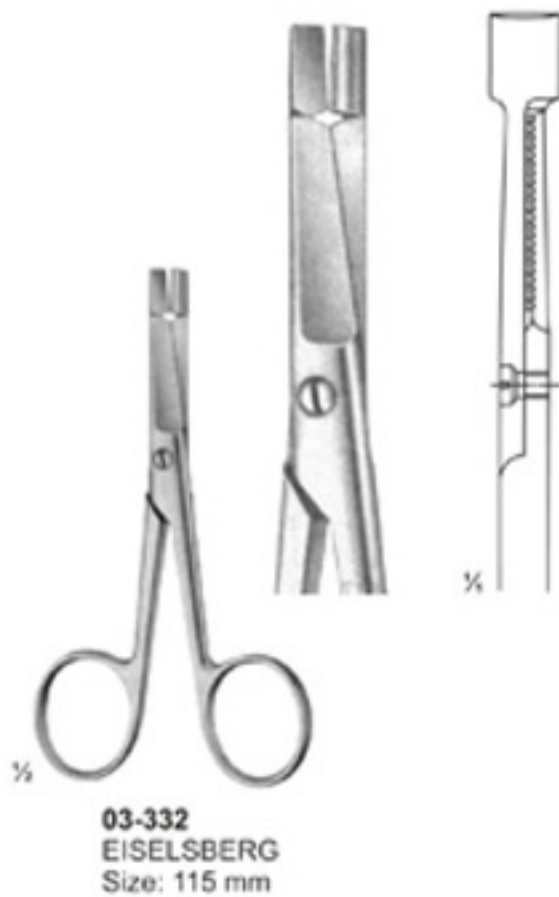
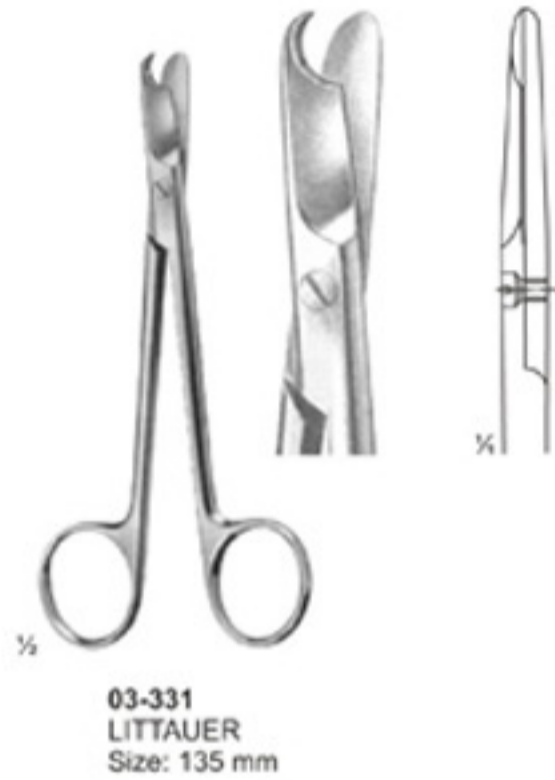



03-334 - 338
BEEBE
Size: 110 mm



03-334



03-335

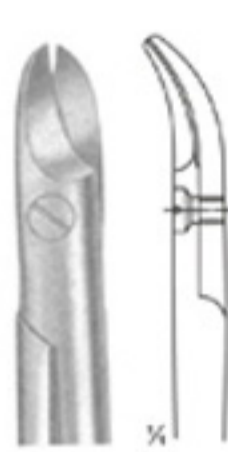

03-336
Broad Blades

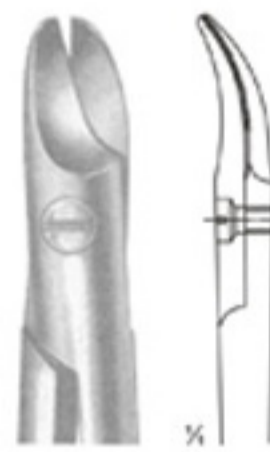

03-337
1 Blade Serrated

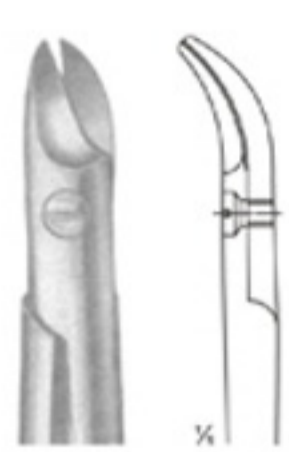

03-338
NAUJOKS
Strongly Curved

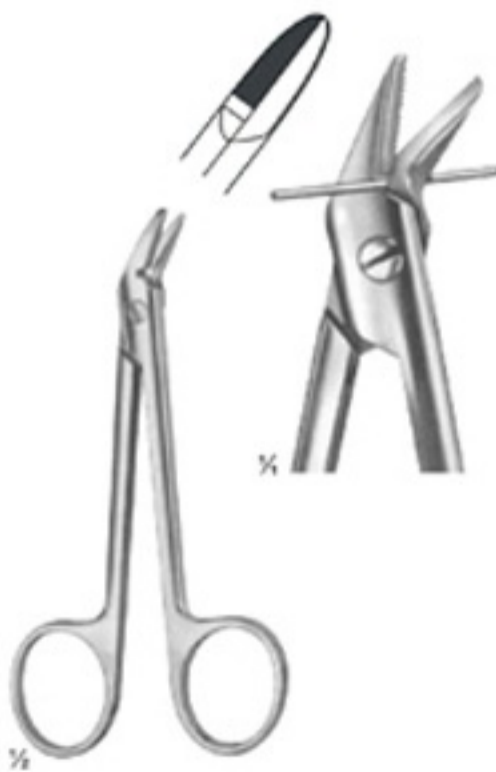

03-339
1 Blade Serrated
Size: 120 mm



03-340
STRACK
Size: 100 mm

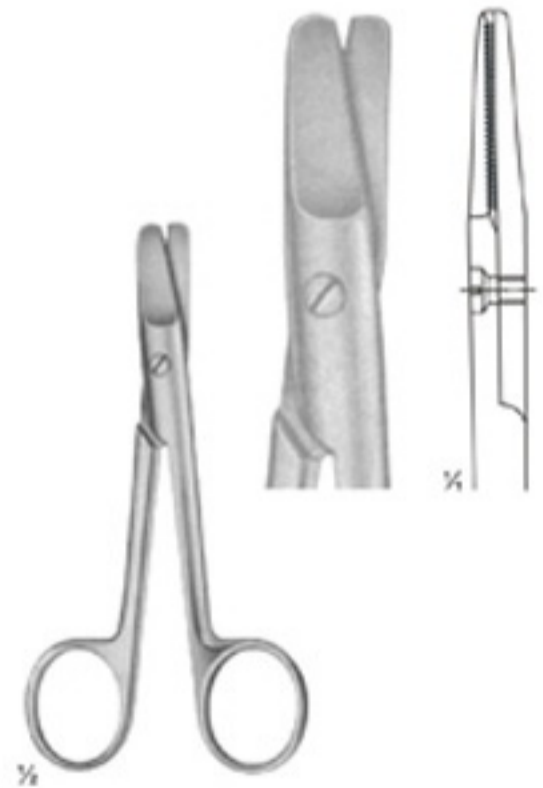

03-341
HARVEY
Size: 125 mm





03-352
UNIVERSAL AND BANDAGE SCISSORS
180 mm



03-353
LISTER
Size: 145 mm

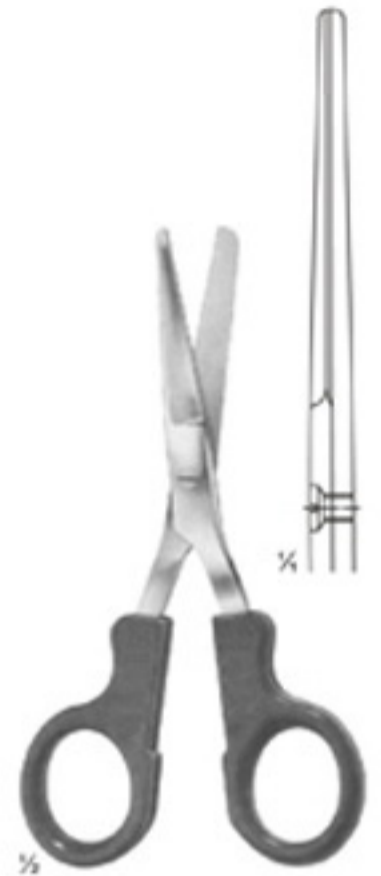

03-354
LISTER
Size: 145 mm

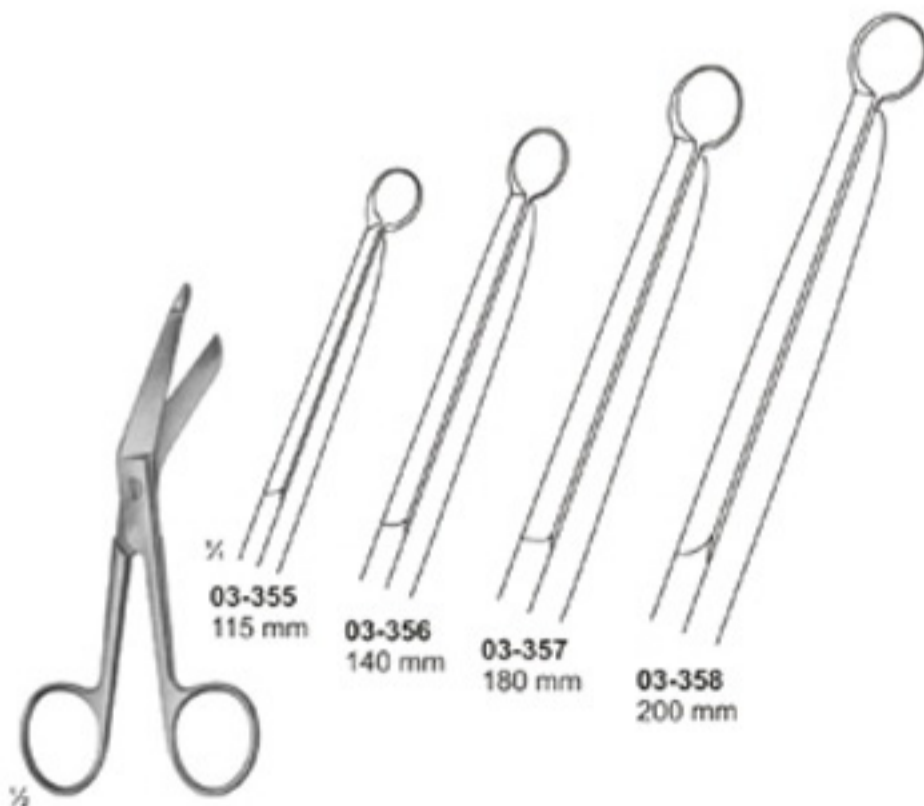

03-355 - 358
LISTER

03-355
115 mm

03-356
140 mm

03-357
180 mm

03-358
200 mm

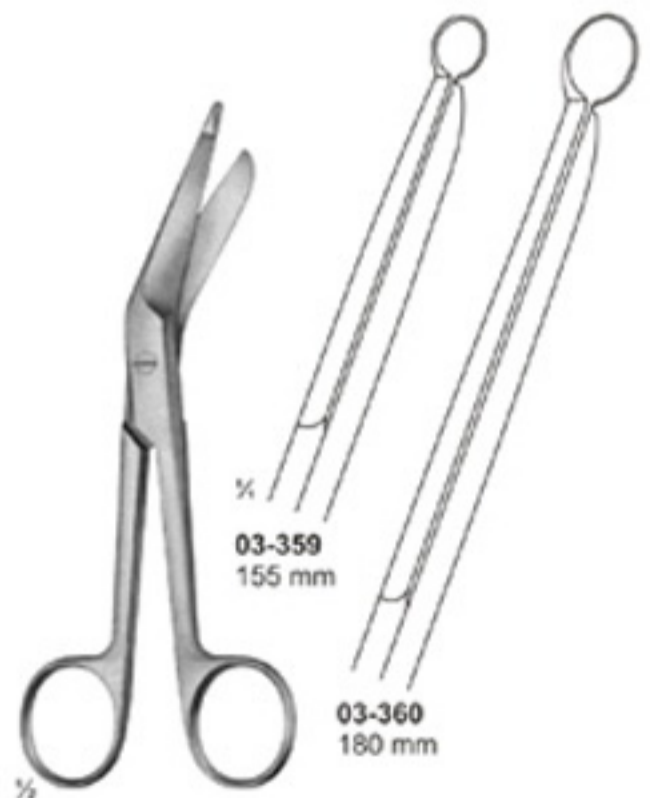

03-359 - 360
LISTER

03-359
155 mm

03-360
180 mm



03-361
CLOTH SCISSORS
205 mm

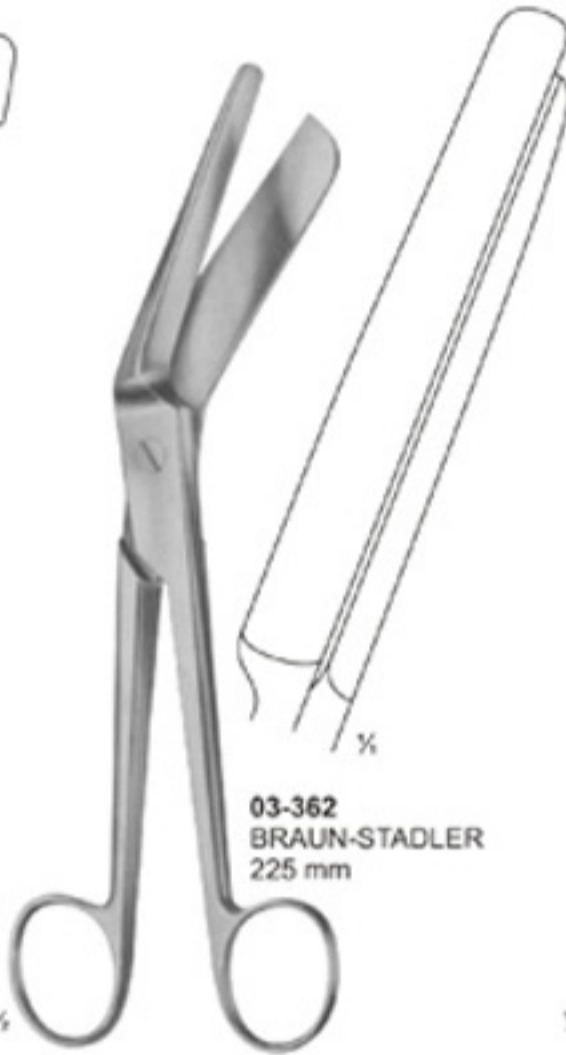

03-362
BRAUN-STADLER
225 mm



03-363
SEUTIN
230 mm



03-364 - 365
ESMARCH



03-364
200 mm



03-366
BRUNS
235 mm



03-367
BRUNS
235 mm

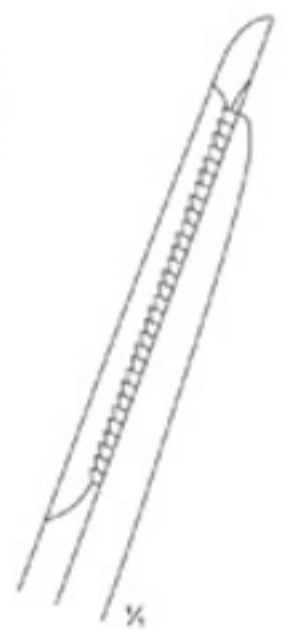

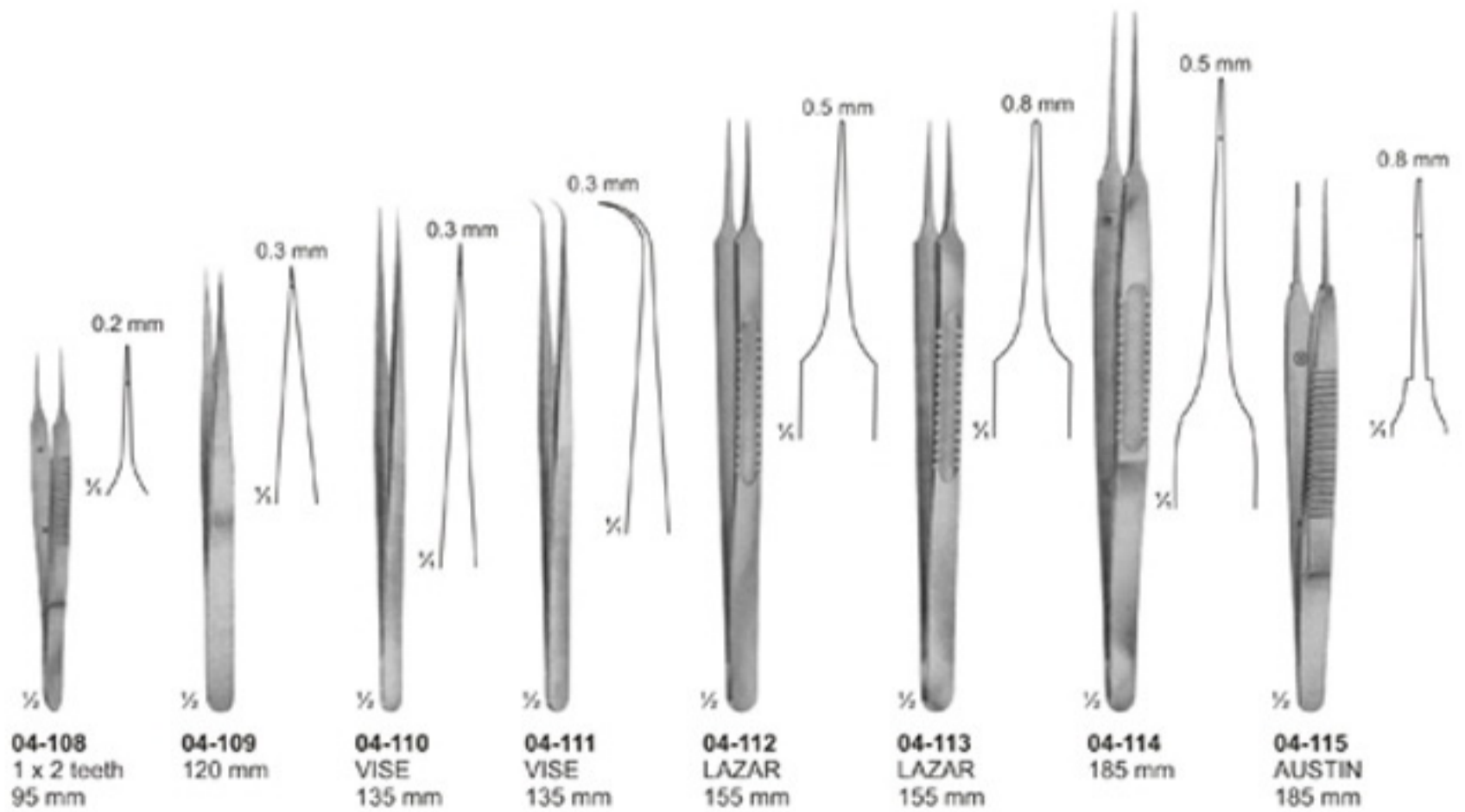
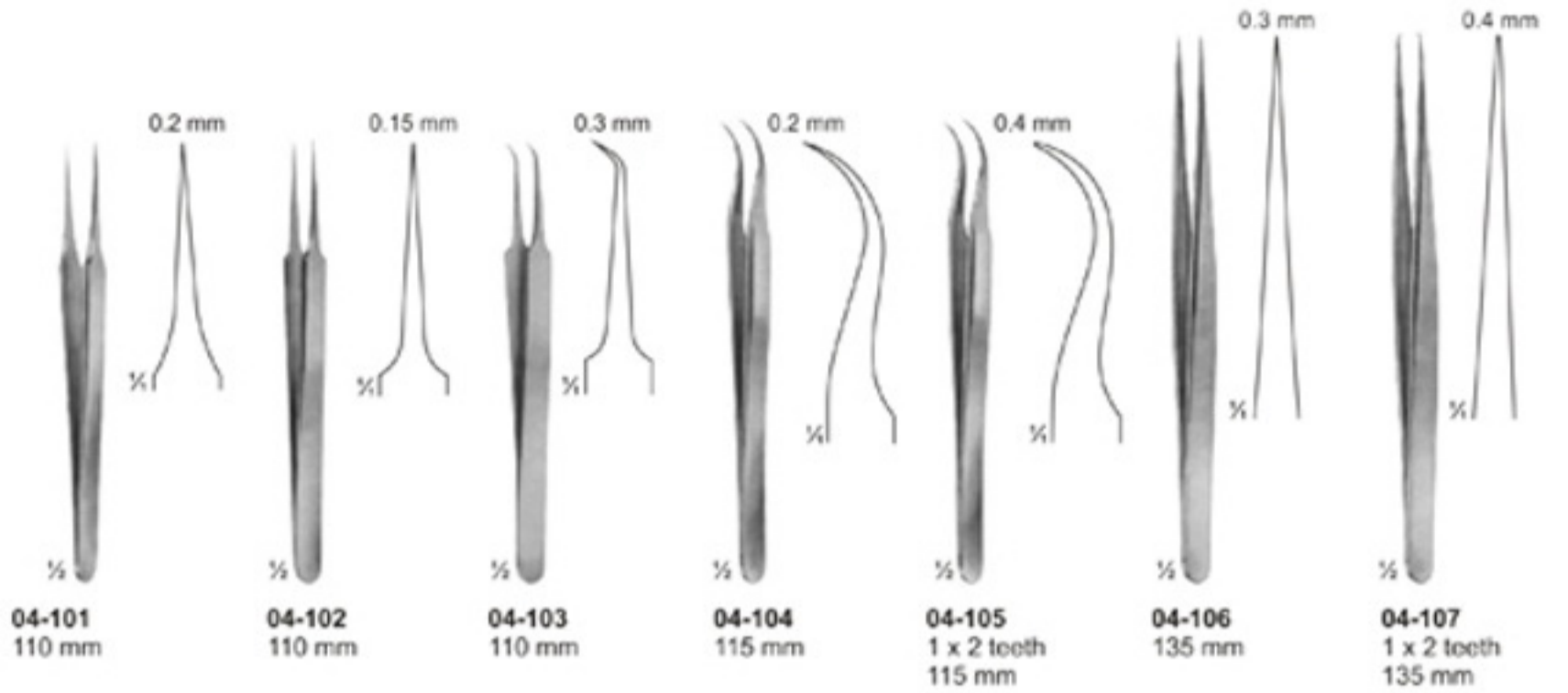

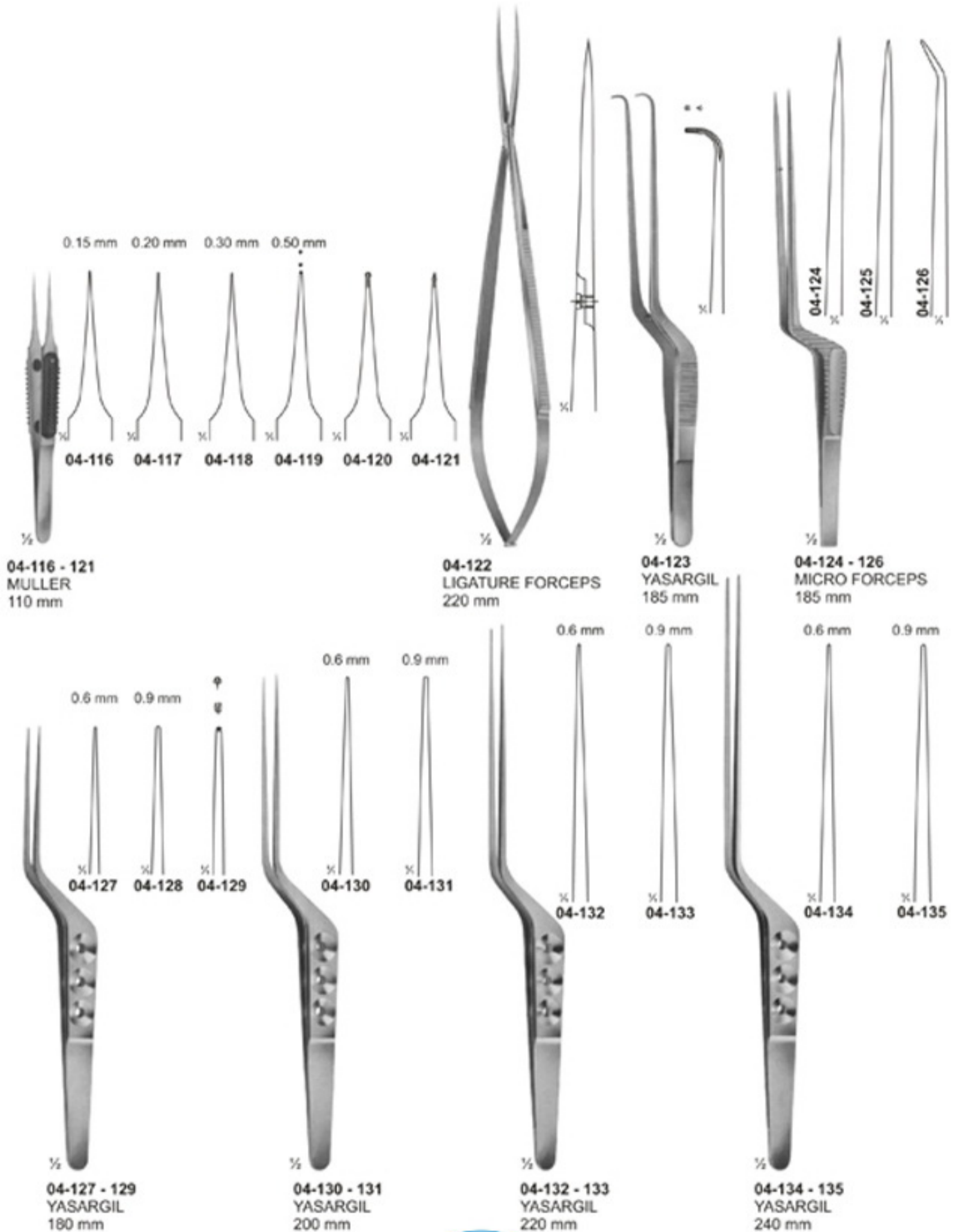



04-136 04-137 04-138

04-136 - 138
YASARGIL-SAM I
Jaws Spoon-Shaped
240 mm



04-139 04-140

04-139 - 140
YASARGIL
Jaws Spoon-Shaped
220 mm



04-141 04-142 04-143

04-141 - 143
SAM II
Jaws Spoon-Shaped
230 mm

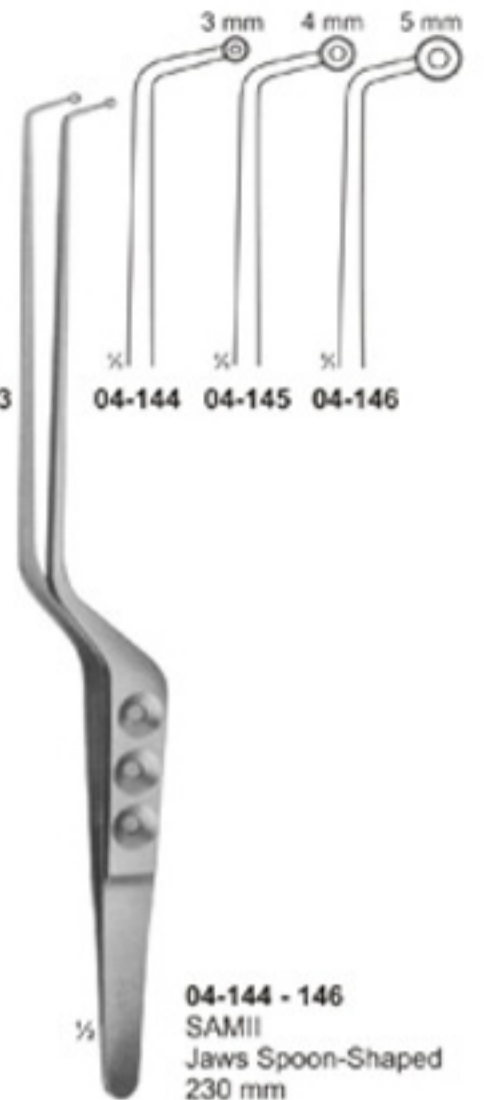

04-144 04-145 04-146

04-144 - 146
SAM II
Jaws Spoon-Shaped
230 mm



04-147
HUNT
Tumor-and Vessel Forceps
200 mm



04-148
HUNT
Tumor-and Vessel Forceps
200 mm



04-149
YASARGIL
Tumor-and Vessel Forceps
200 mm

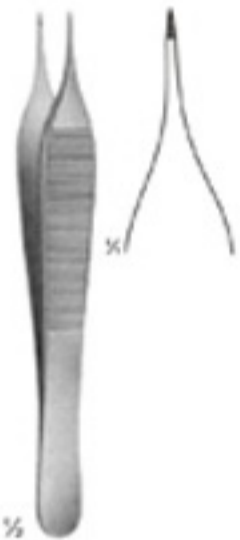

04-150
THORPE
Corneal Forceps
120 mm

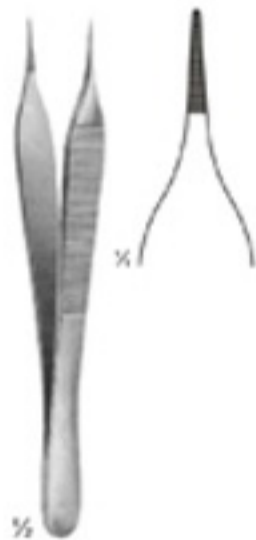

04-151
MICRO-ADSON
120 mm

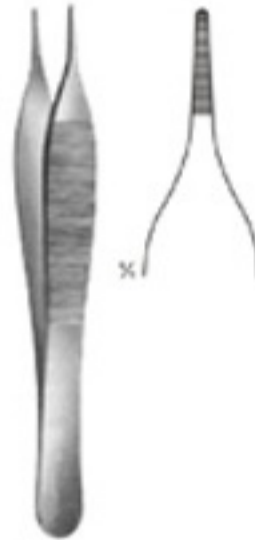

04-152
ADSON
120 mm



04-153
MICRO-ADSON
150 mm



04-154 - 156
100 mm



04-154



04-155



04-156

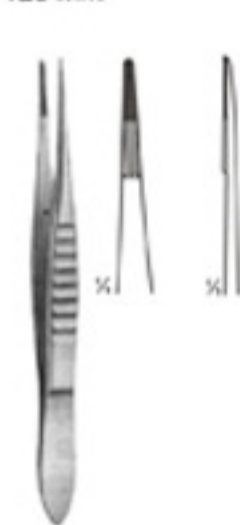

04-157
110 mm



04-158
115 mm

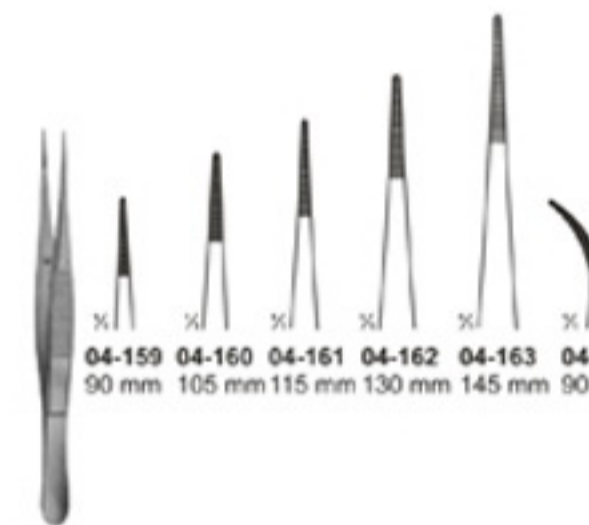

04-159 - 168

04-159
90 mm

04-160
105 mm

04-161
115 mm

04-162
130 mm

04-163
145 mm

04-164
90 mm

04-165
105 mm

04-166
115 mm

04-167
130 mm

04-168
145 mm



04-172
COVER GLASS FORCEPS
105 mm

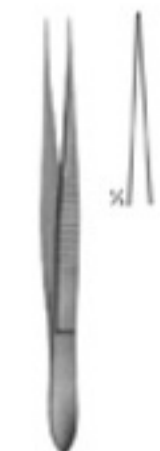

04-169
100 mm

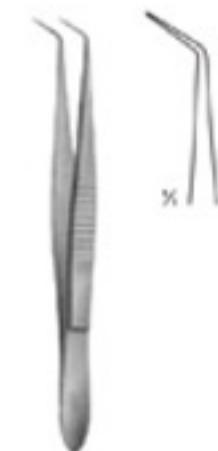

04-170
100 mm



04-171
100 mm

04-173
160 mm

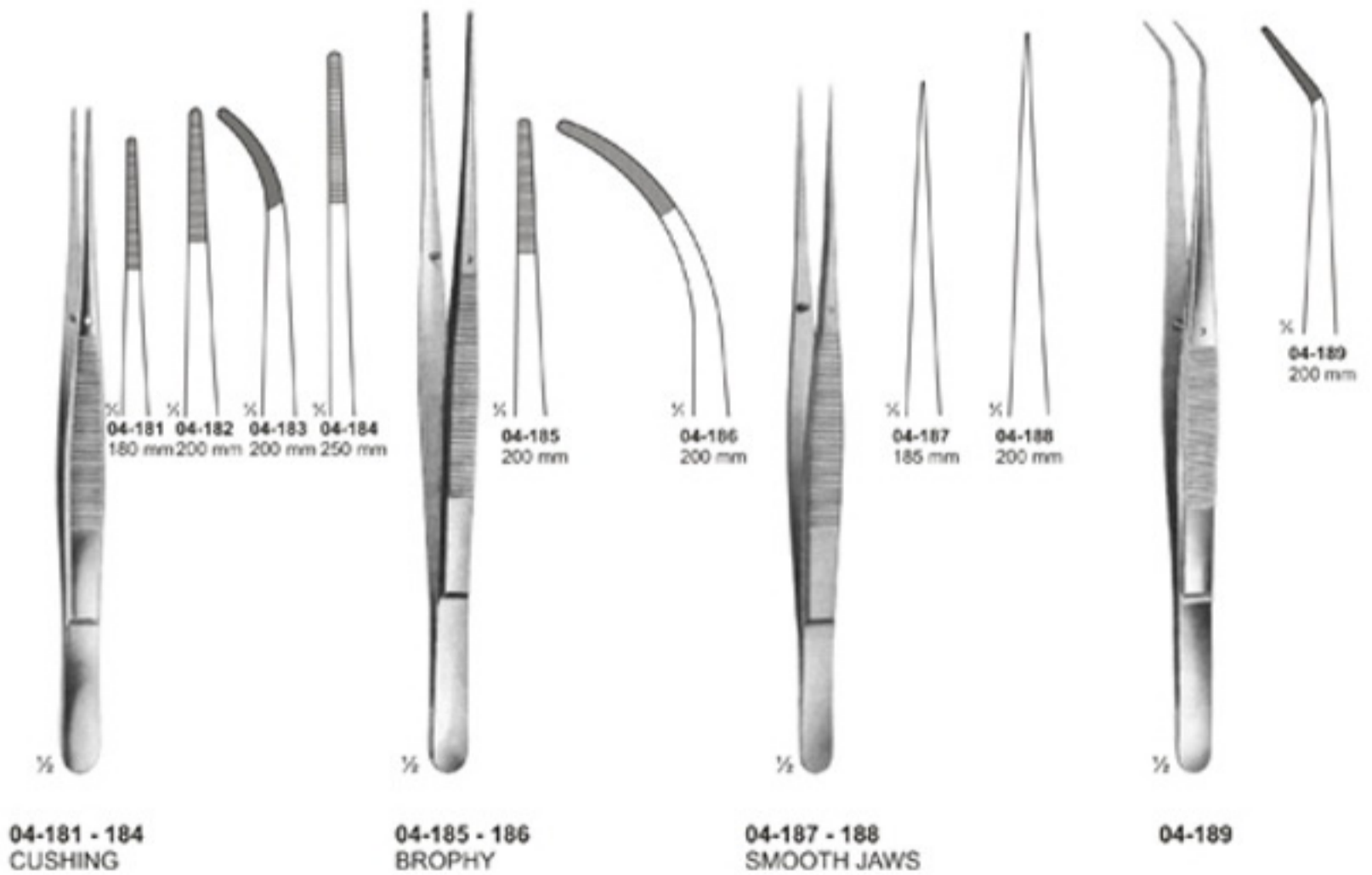
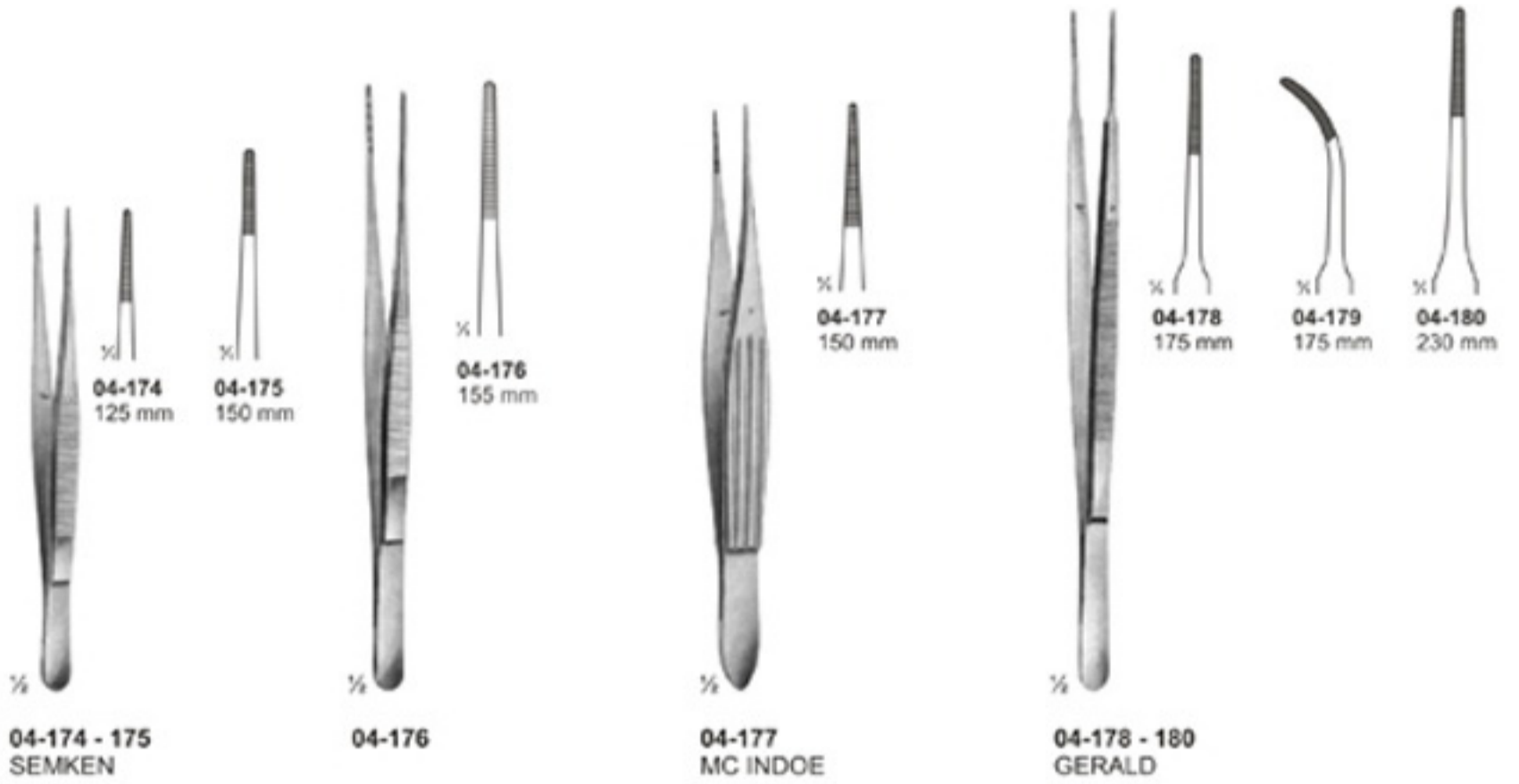



04-190 - 197
STANDARD

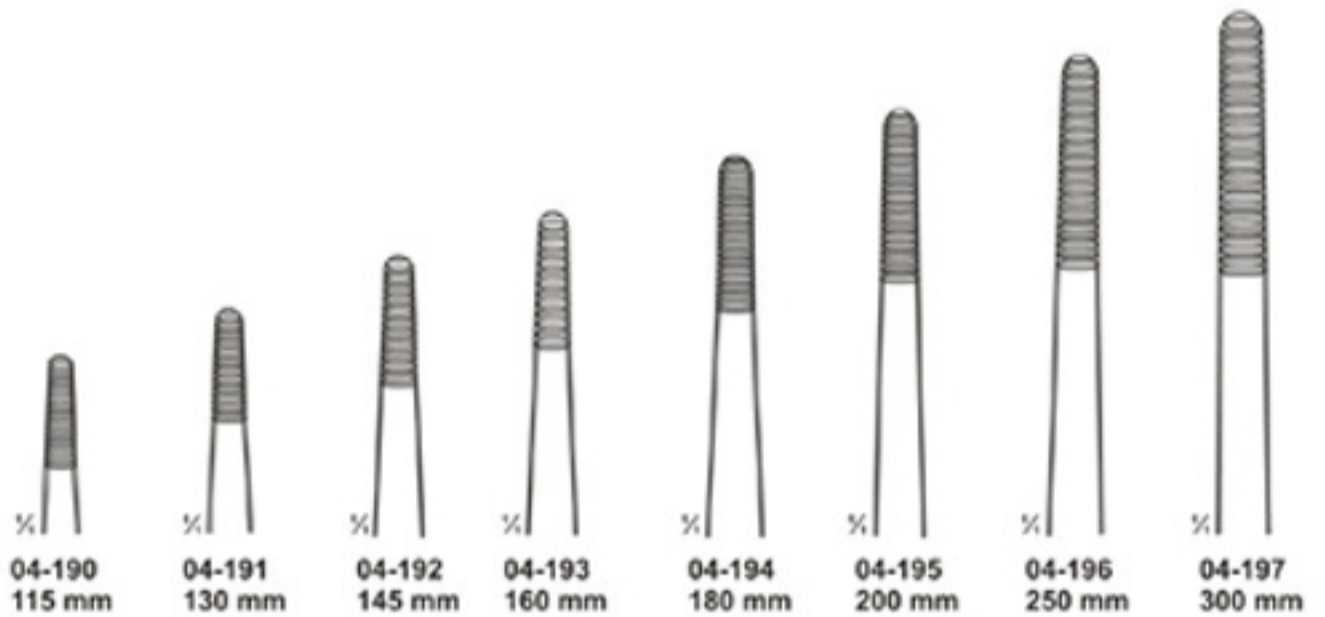

04-198 - 202
MEDIUM

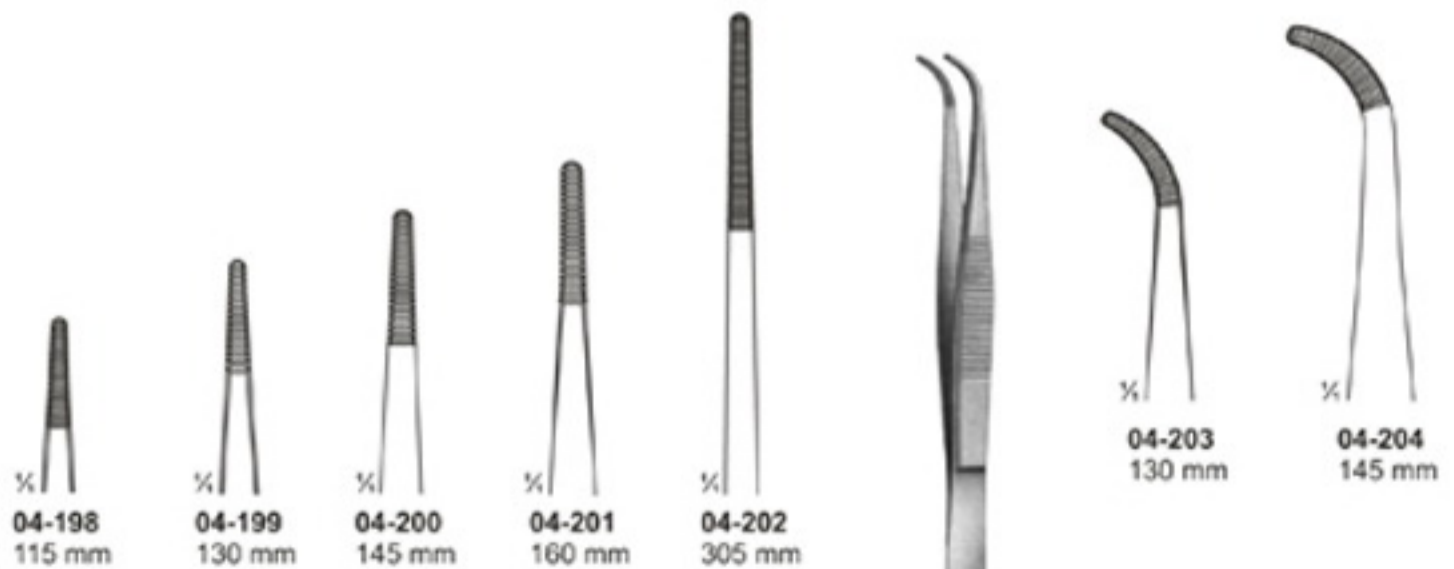

04-203 - 204
MEDIUM



04-205 - 206



04-205
125 mm



04-206
155 mm



04-207 - 210



04-207
130 mm



04-208
150 mm



04-209
170 mm



04-210
200 mm



04-211
OCHSNER



04-212
FRICKE



04-213
BONNEY





04-214
150 mm

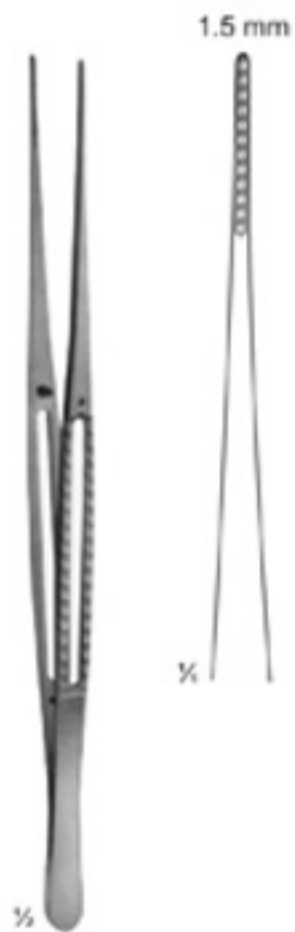

04-215
200 mm



04-216
240 mm



04-217
300 mm

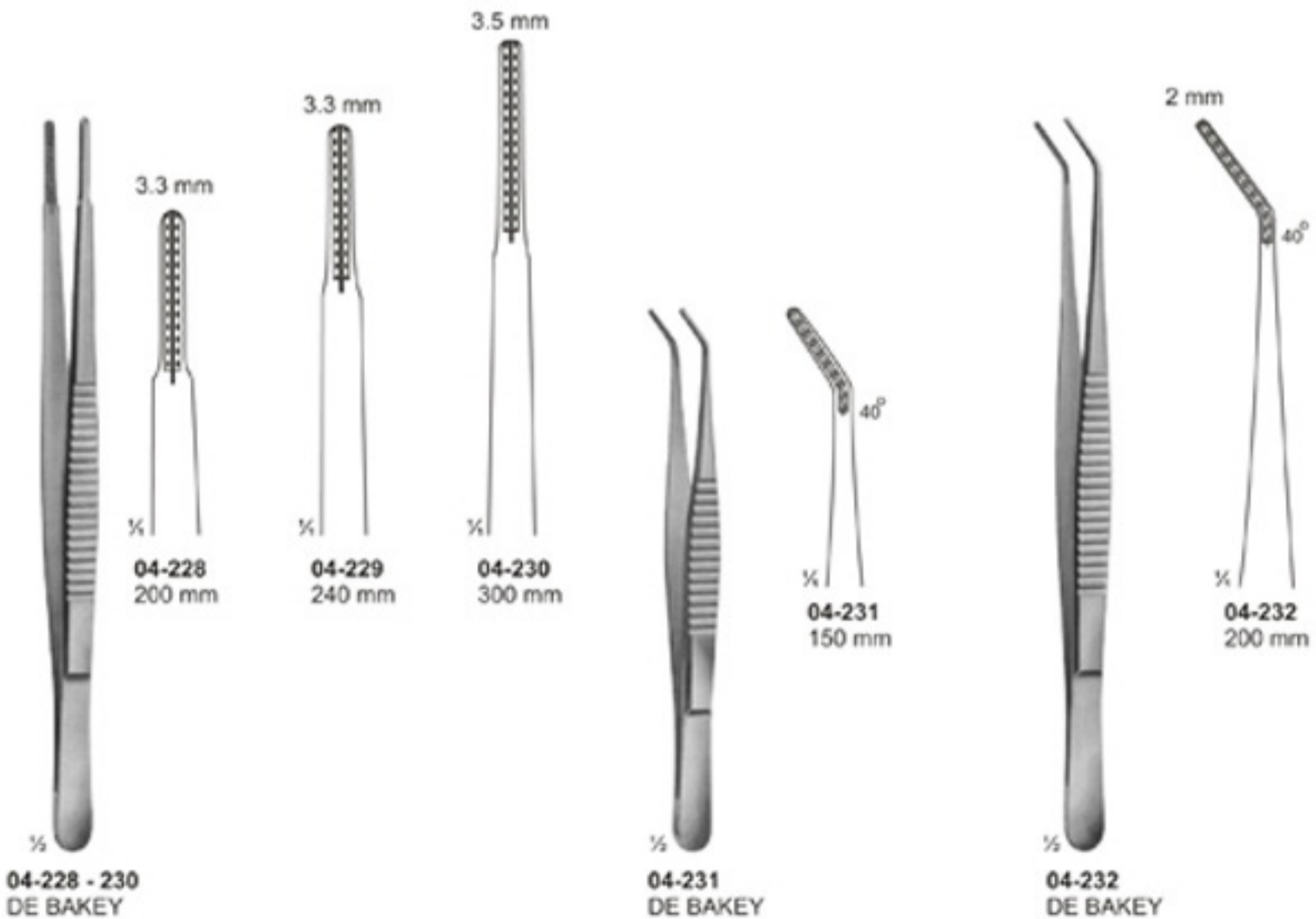
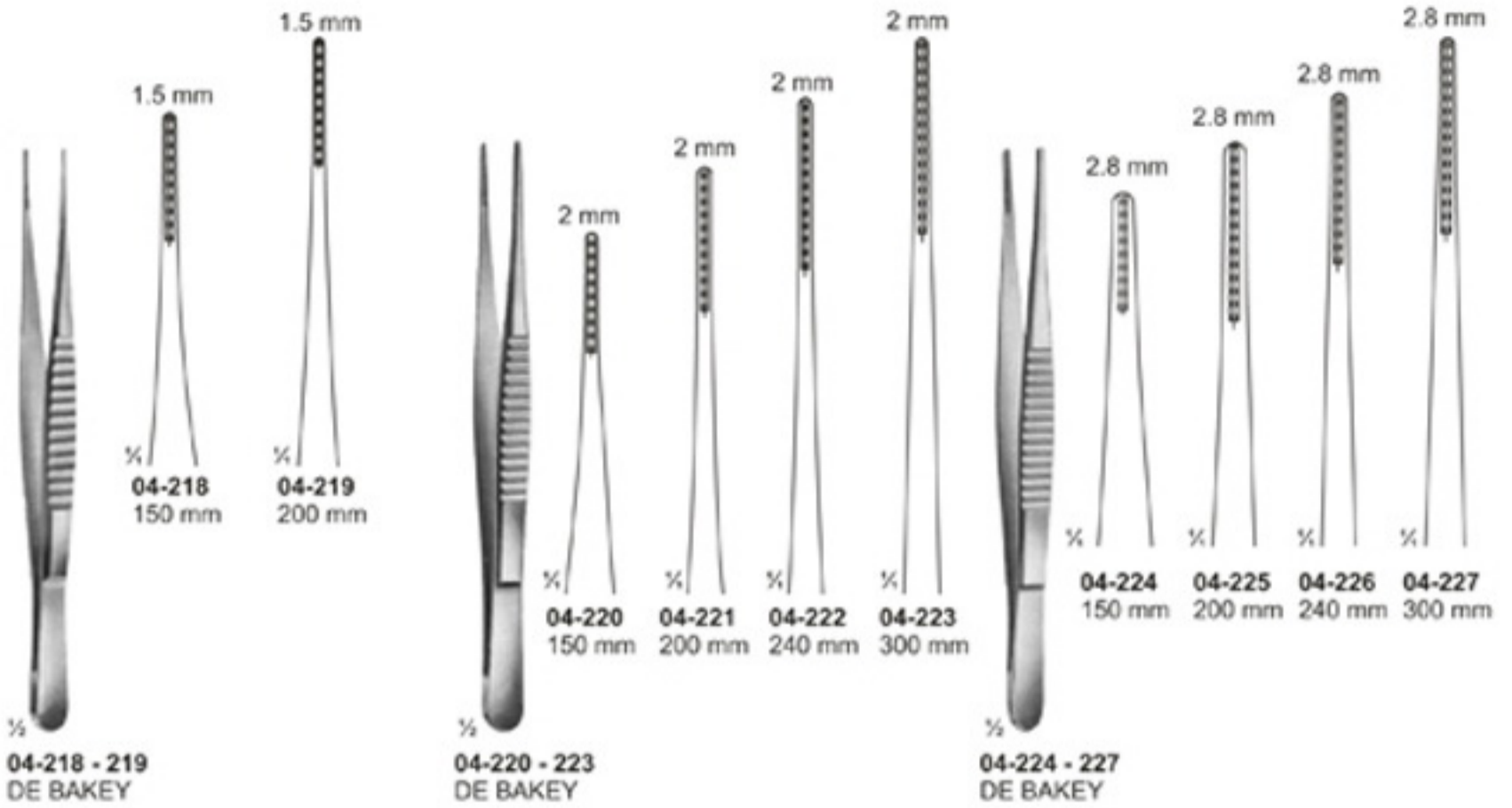



04-233
LUCAE
140 mm



04-234
LUCAE
1x2 teeth
140 mm



04-235
COTTLE
Forceps with
jaws toothed
and serrated
140 mm



04-236
JANSEN
160 mm



04-237
GRUENWALD
200 mm



04-238
1x2 teeth
200 mm



04-239
TROELTSCH
100 mm

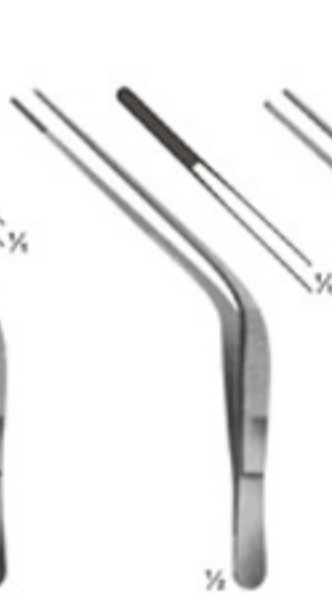

04-240
TROELTSCH
115 mm

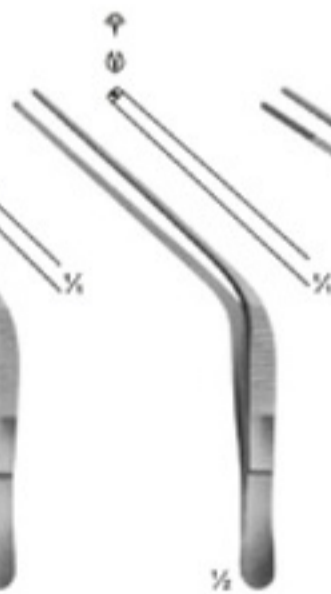

04-241
TROELTSCH
1X2 teeth
115 mm

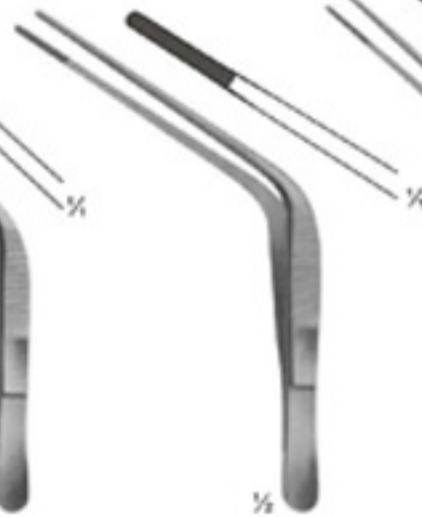

04-242
WILDE
115 mm



04-243
TROELTSCH
Cross action
120 mm



04-244
TROELTSCH
140 mm



04-245
BISHOP-HARMON
85 mm



04-246
ST. MARTIN
80 mm



04-247
CASTROVIEJO
teeth 0.9 mm
100 mm

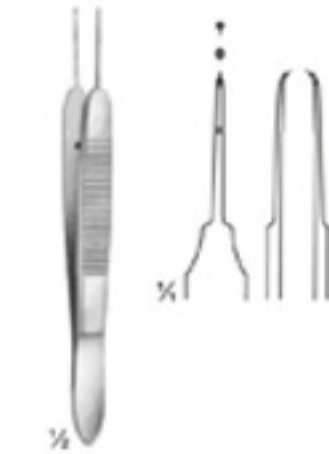

04-248
CASTROVIEJO
teeth 0.5 mm
100 mm

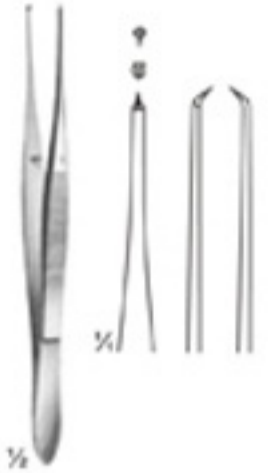

04-249
ELSCHING
110 mm



04-250
GILL
75 mm



04-251
GILL - HESS
75 mm



04-252
HESS
70 mm



04-253
ARRUGA
100 mm

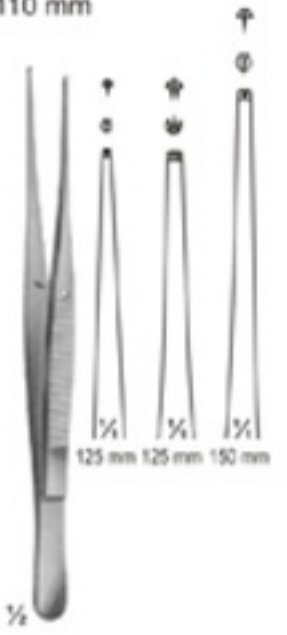

04-254
SEMKEN
125 mm 125 mm 150 mm

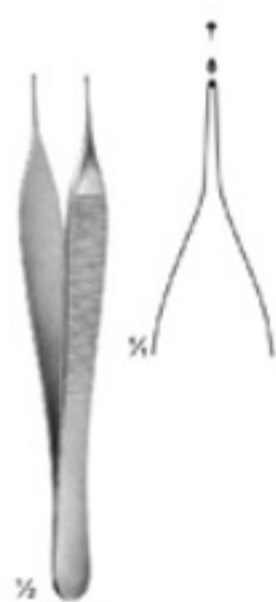

04-255
MICRO-ADSON
120 mm

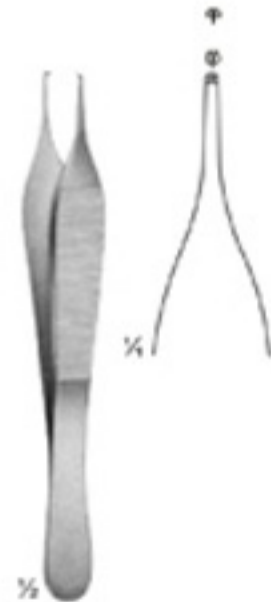

04-256
ADSON
120 mm



04-257
ADSON
120 mm



04-258
ADSON
120 mm



04-259
ADSON
150 mm

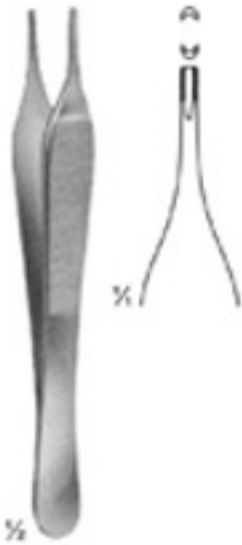

04-260
ADSON - BROWN
Non-traumatic
120 mm

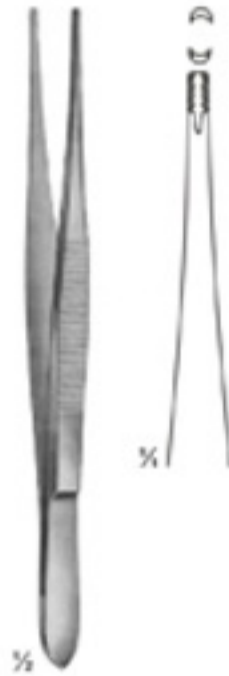

04-261
BROWN
120 mm



04-262
GRAEFE
110 mm

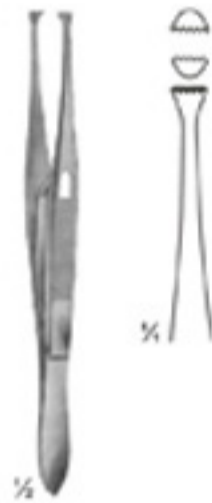

04-263
GRAEFE
With Catch
110 mm

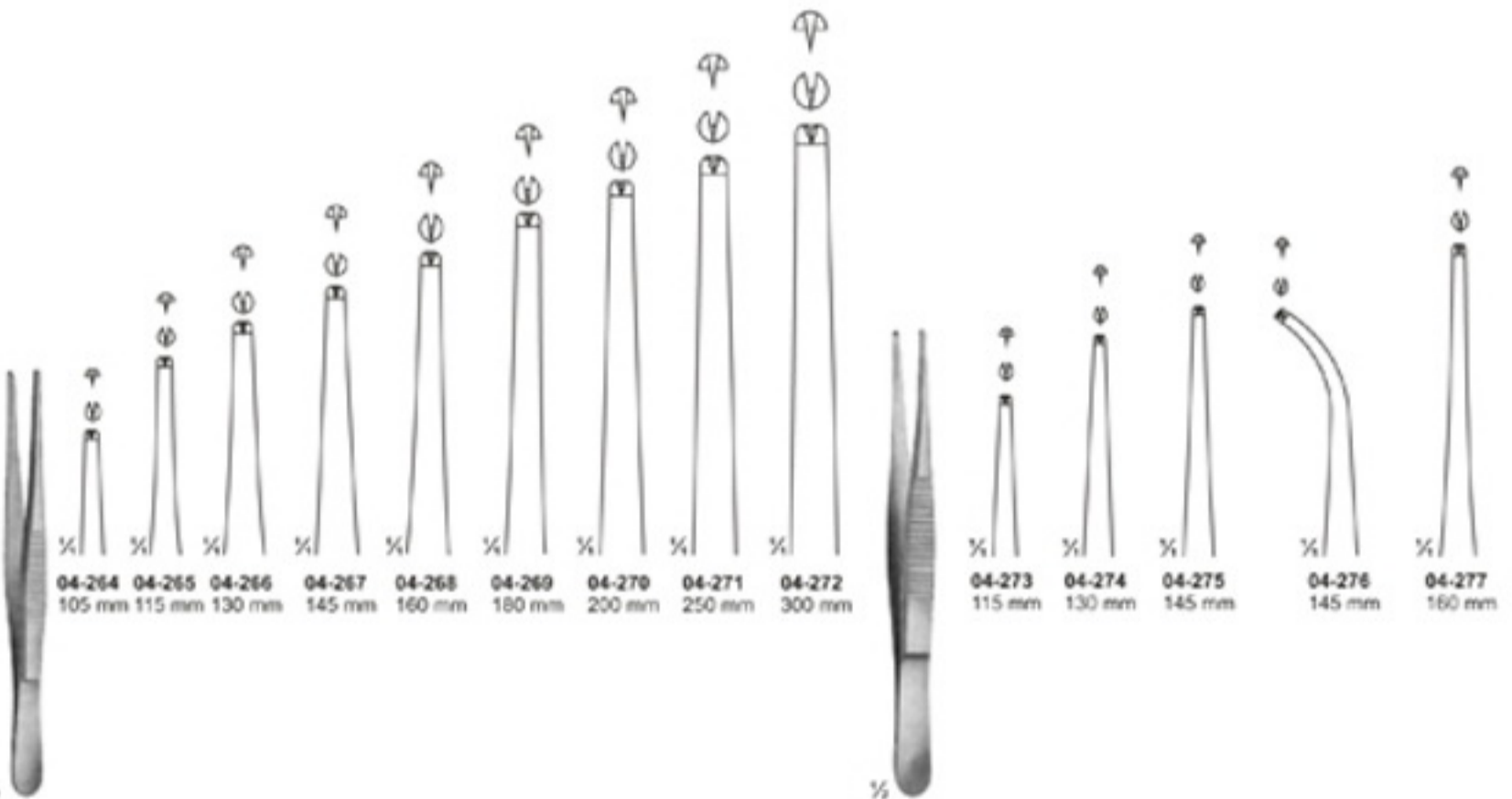

04-264 - 272
STANDARD

04-273 - 277
GRAEFE
110 mm

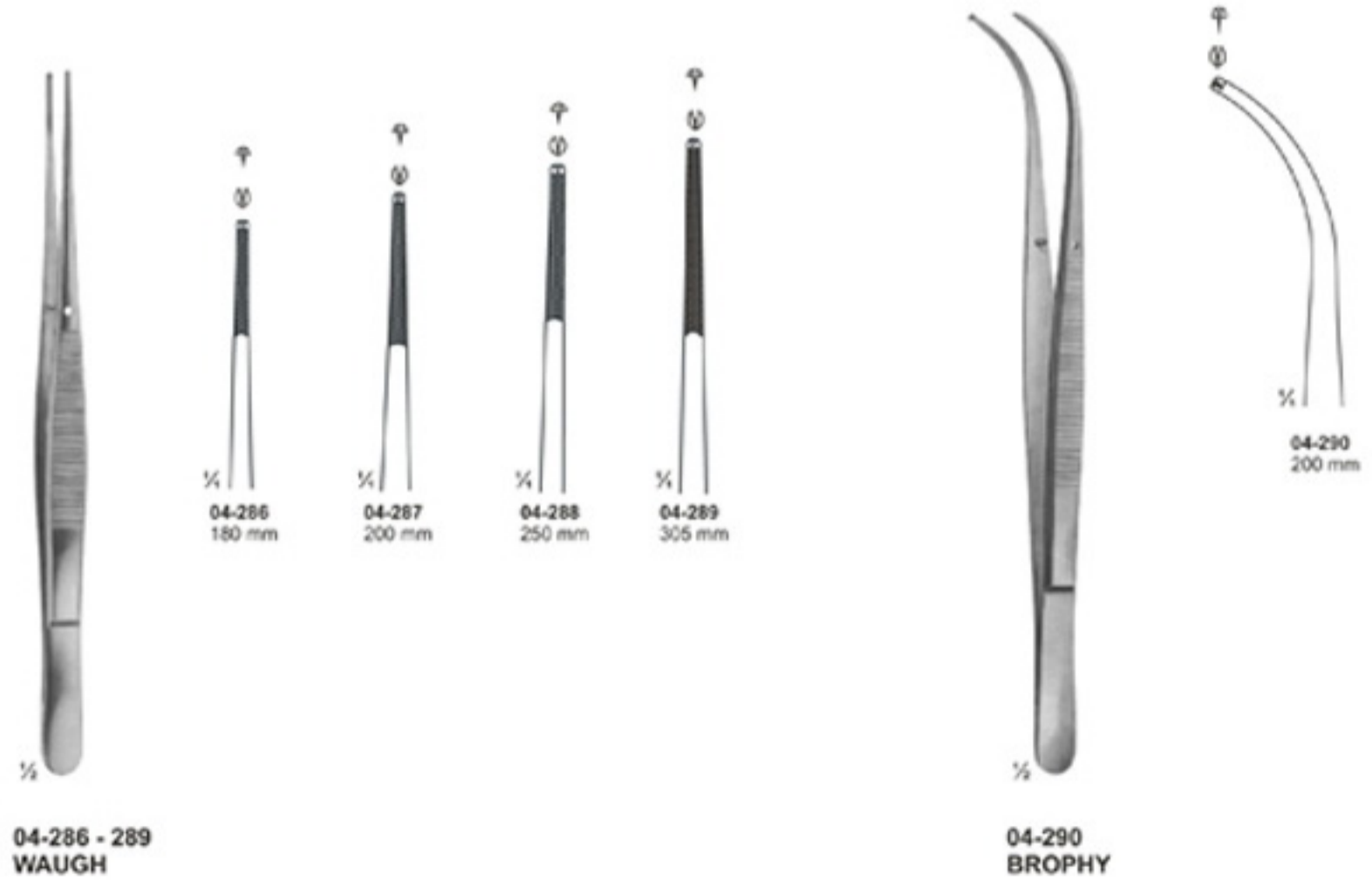
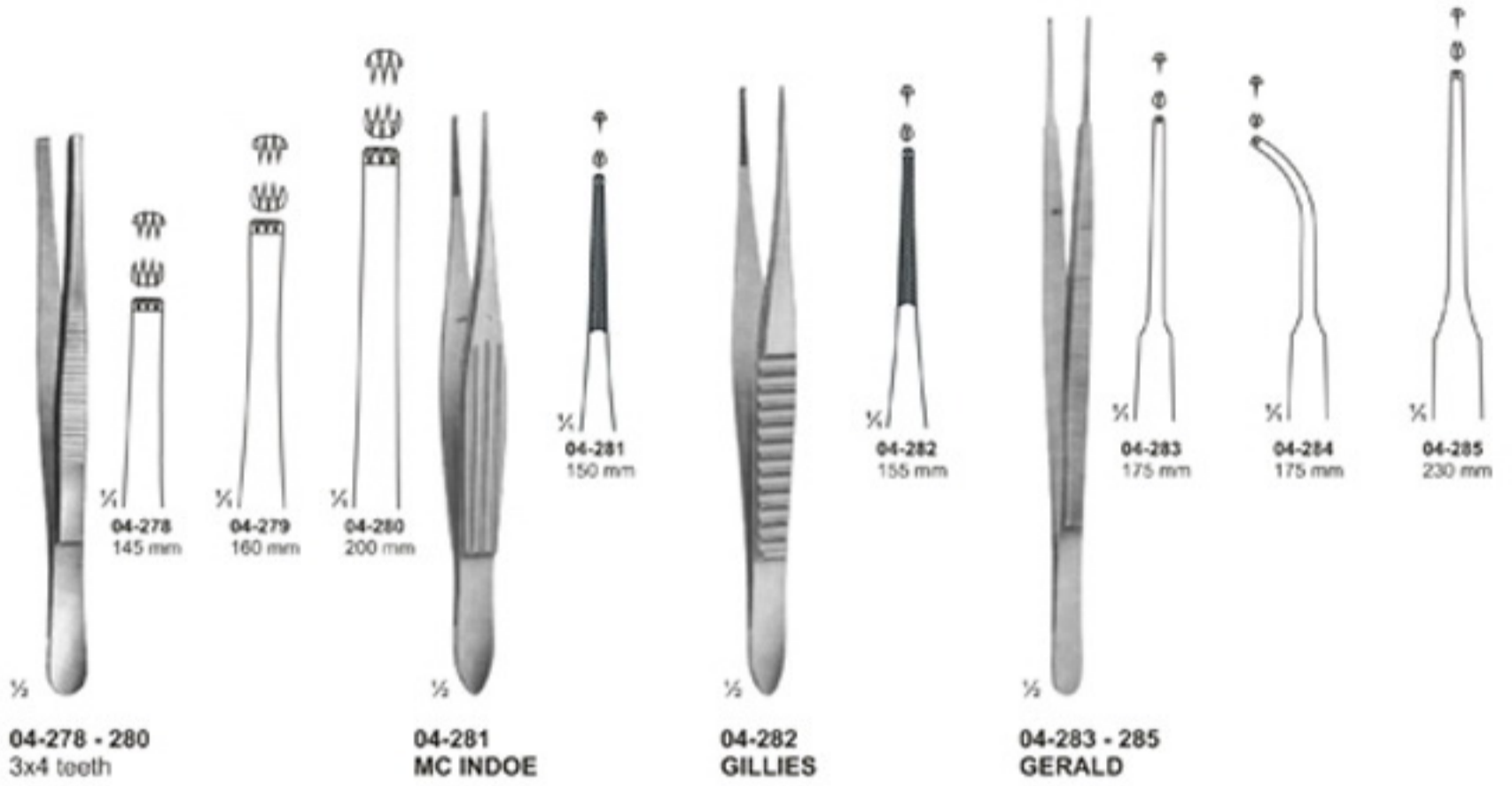

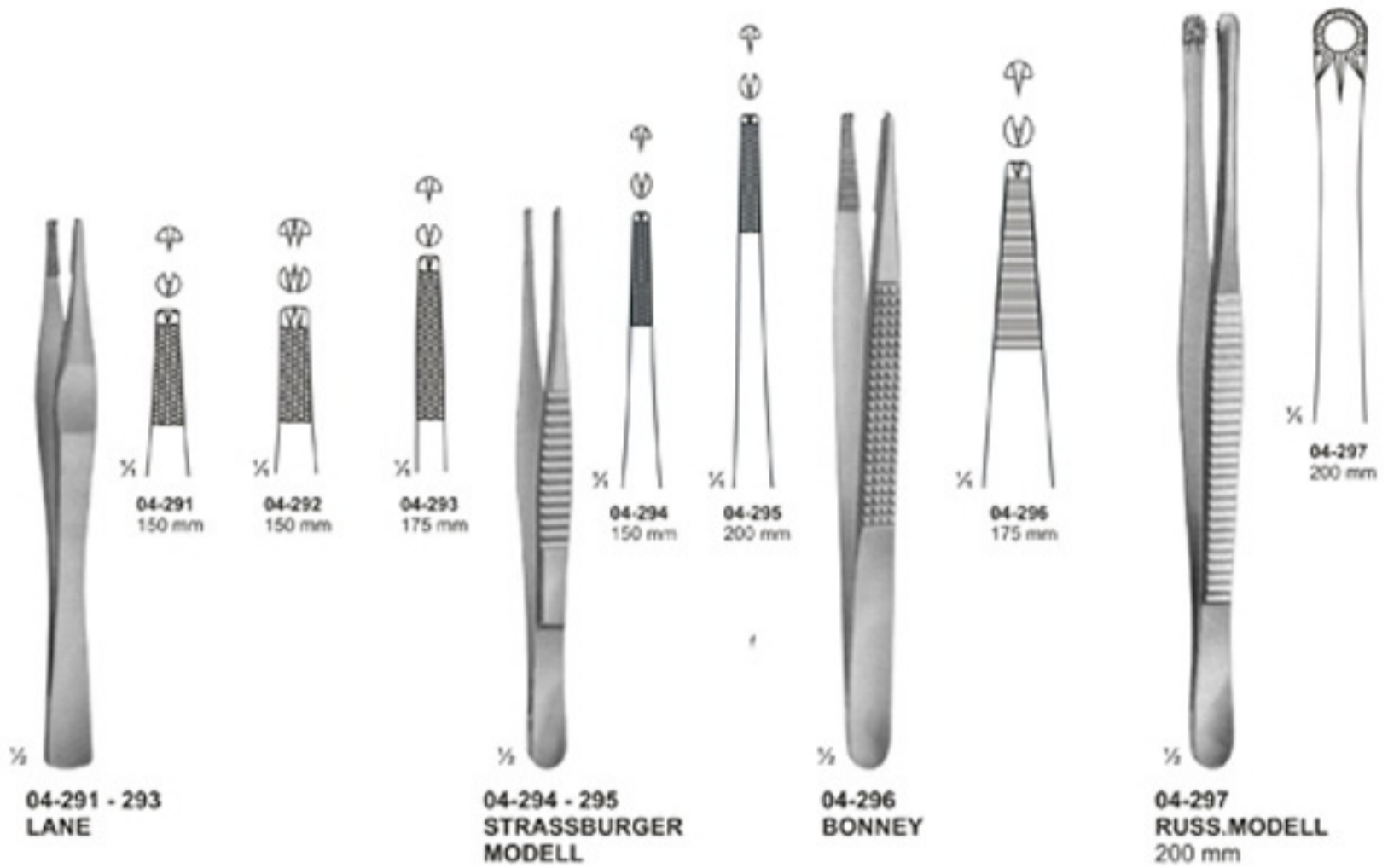

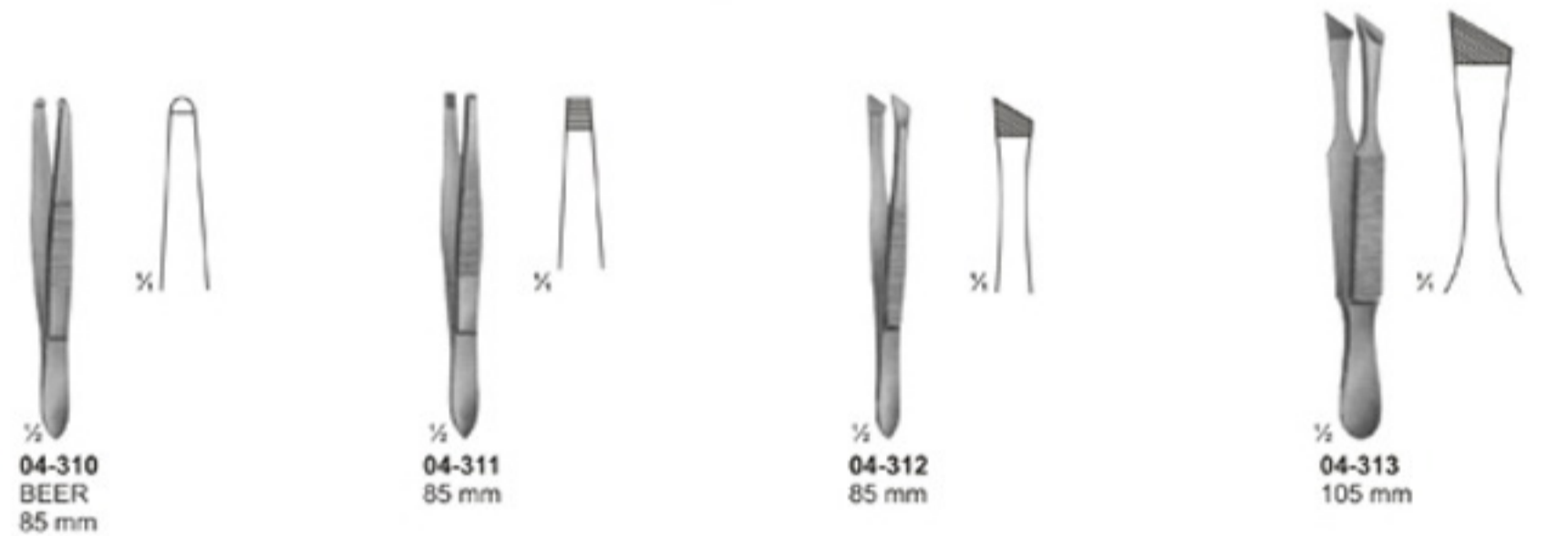

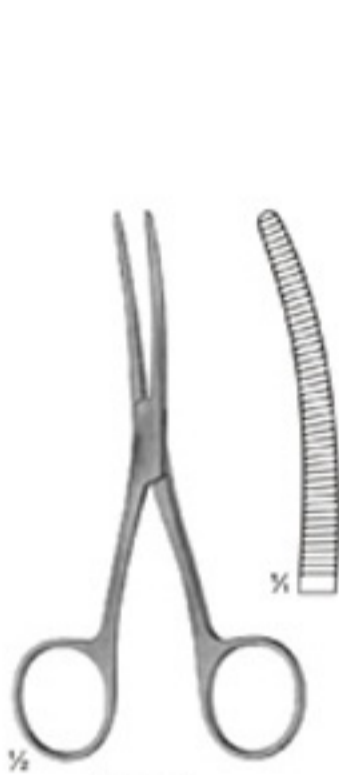

04-318
BRYANT
130 mm

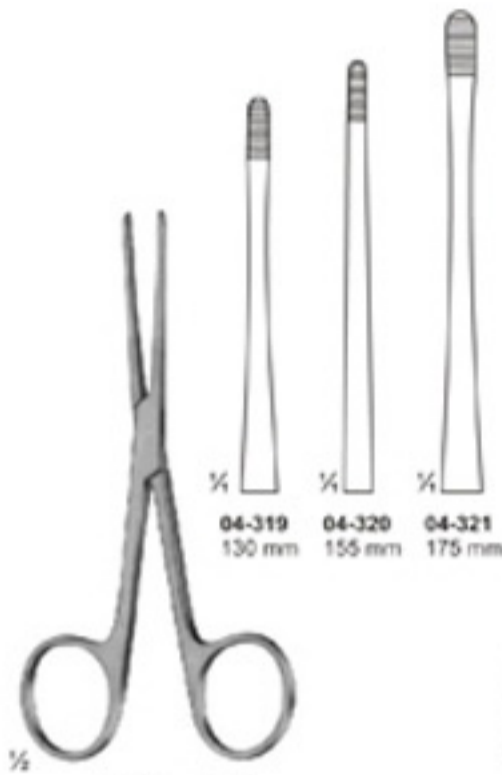

04-319 - 321
LISTER
Sinus Forceps

04-319 130 mm
04-320 155 mm
04-321 175 mm



04-322
Without Ratchet
145 mm



04-323
With Ratchet
145 mm



04-324 - 325
GROSS
Without Ratchet
200 mm

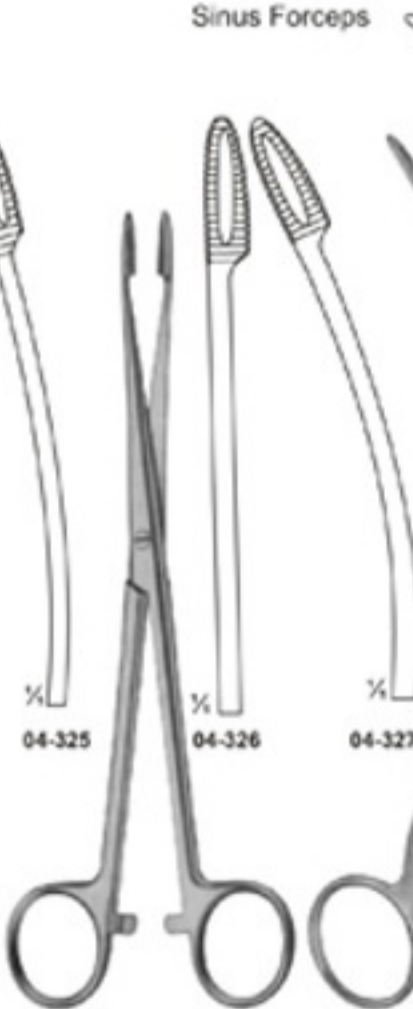

04-326 - 327
GROSS
With Ratchet
180 mm



04-328
DUPLAY
190 mm

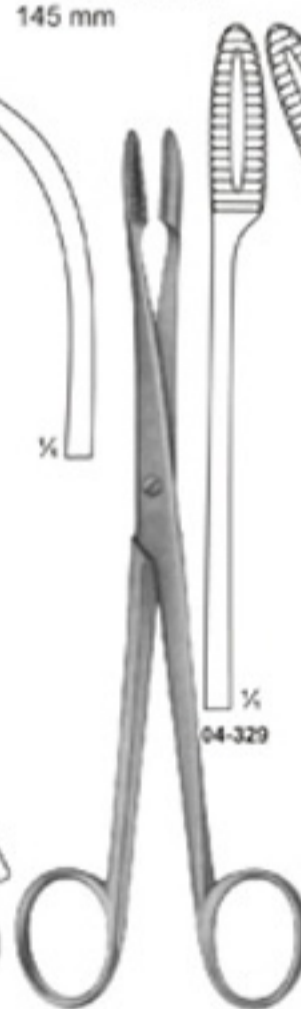

04-329 - 330
GROSS
Without Ratchet
200 mm

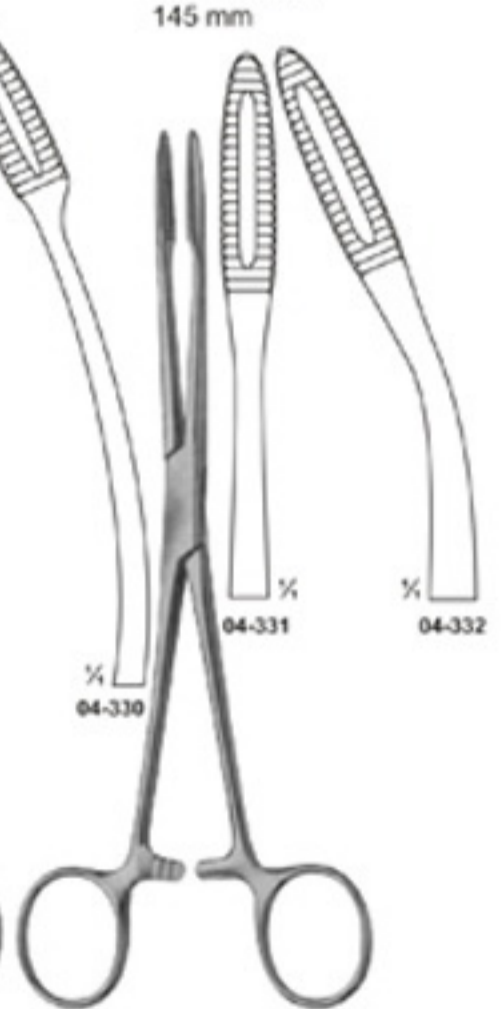

04-331 - 332
GROSS
With Ratchet
200 mm



04-333 - 334
AESCULAP
220 mm

04-335 - 336
MAIER
Without Ratchet
265 mm

04-337 - 338
MAIER
With Ratchet
265 mm

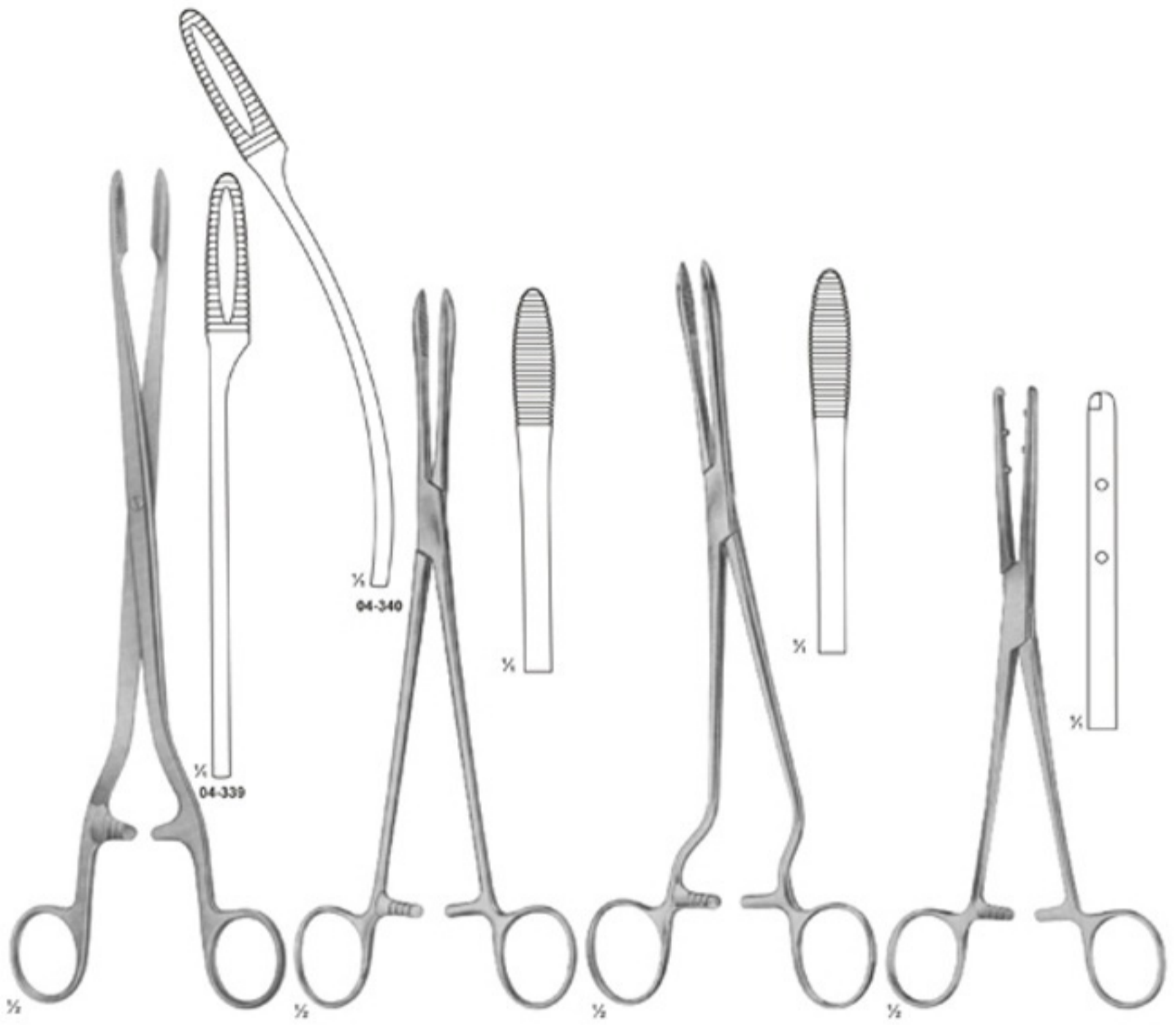

04-339 - 340
SIMS-MAIER
280 mm

04-341
COLLIN
240 mm

04-342
CHERON
Handles Laterally Angled
240 mm

04-343
EMMET
210 mm

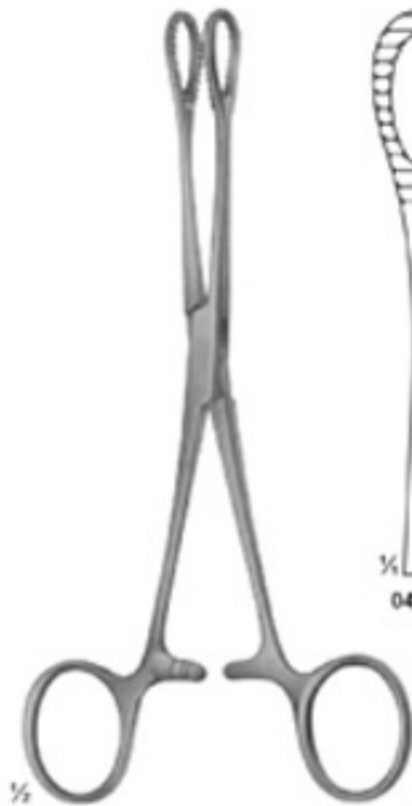

04-344 - 345
FOERSTER-BALLENGER
180 mm



04-344



04-345



04-346 - 347
RAMPLEY



04-346
180 mm



04-347
250 mm



04-348 - 351
FOERSTER-BALLENGER
240 mm



04-348
Smooth Jaws



04-349
Smooth Jaws



04-350
Serrated Jaws



04-351
Serrated Jaws

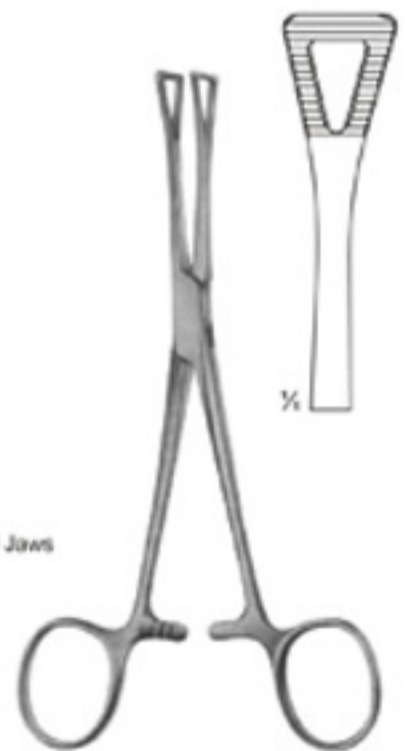

04-352
PENNINGTON
155 mm

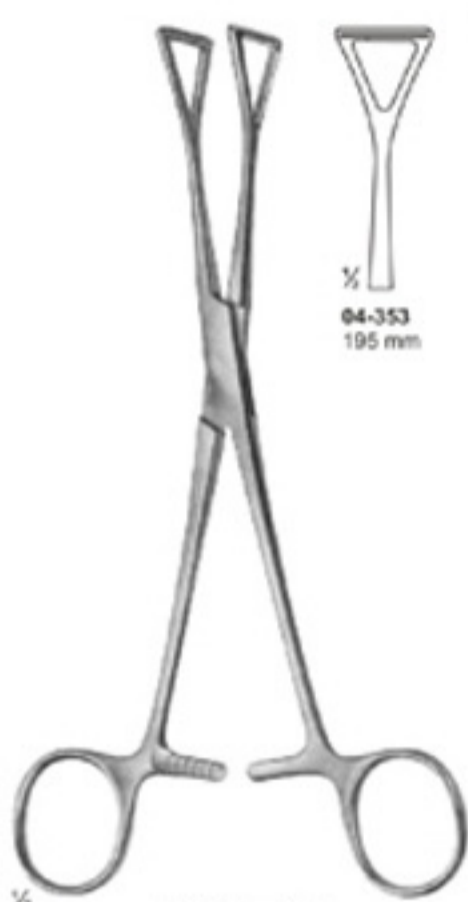

04-353 - 354
COLLIN

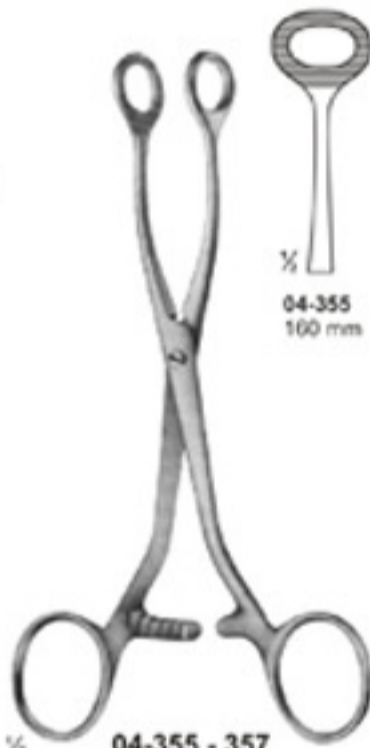

04-355 - 357
COLLIN

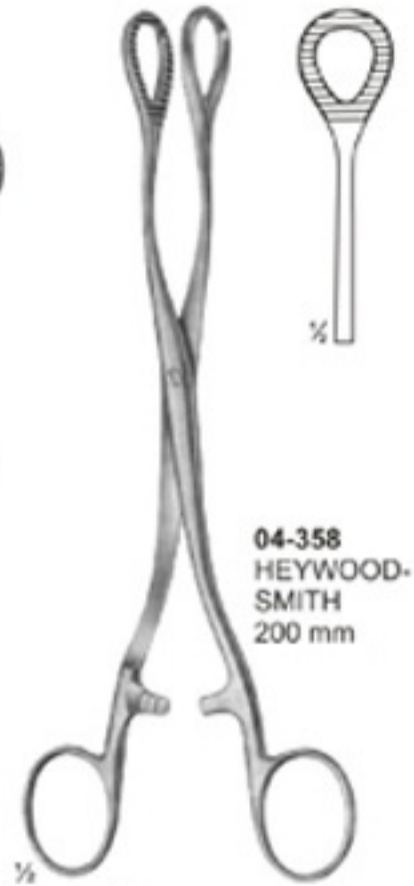

04-358
HEYWOOD-SMITH
200 mm

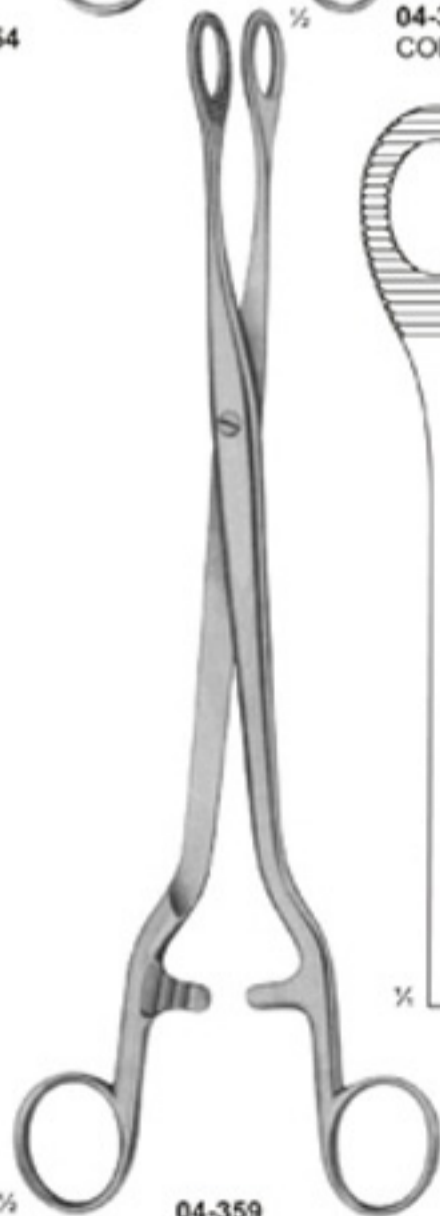

04-359
NOTO
280 mm



04-360
KELLY
320 mm



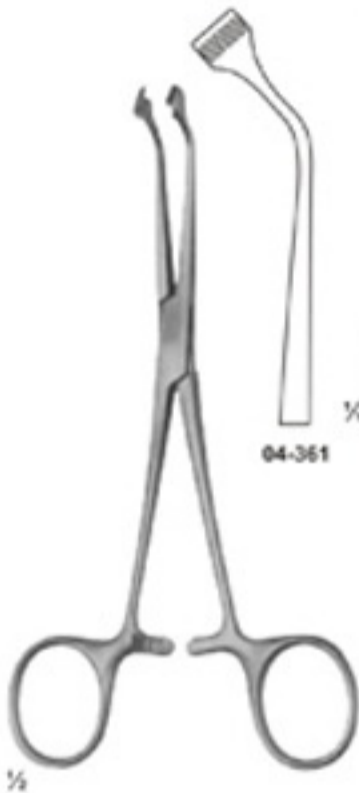

04-361 - 362
HERZ
155 mm



04-363
JACKSON
4 x 5 teeth
150 mm

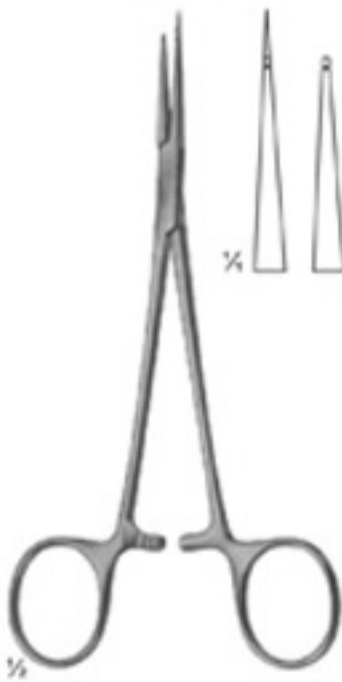

04-364
150 mm



04-365
150 mm



04-366
120 mm

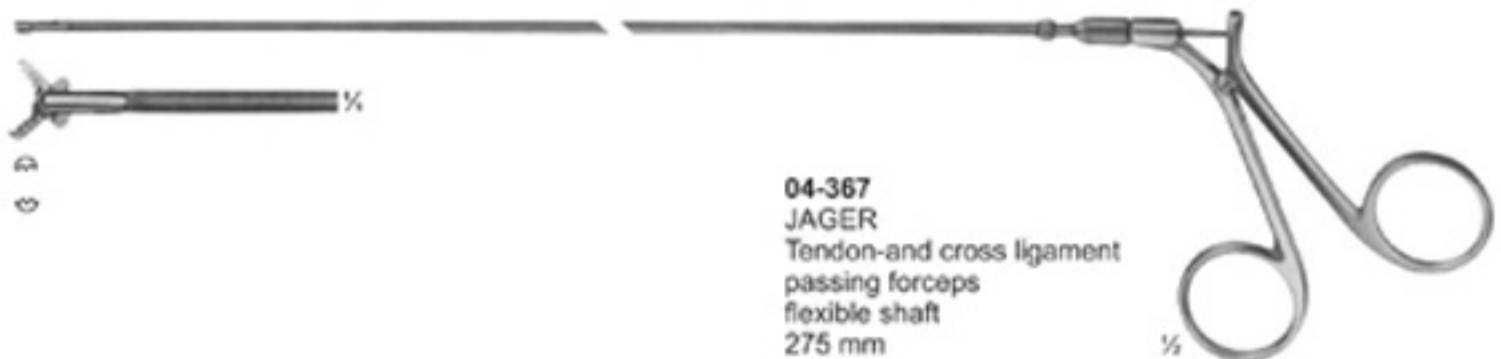
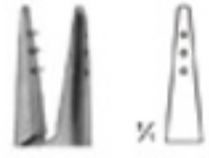

04-367
JAGER
Tendon and cross ligament
passing forceps
flexible shaft
275 mm

Artery Traction - and Tissue Grasping Forceps

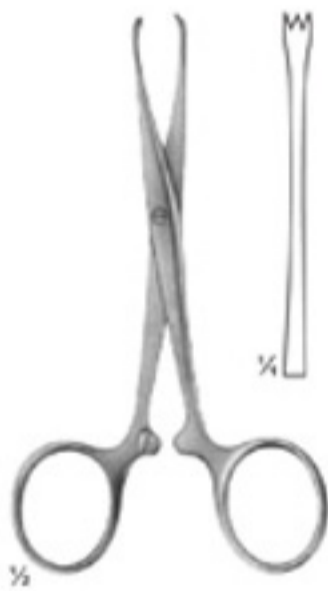

04-368
CHAPUT
2 x 3 teeth
125 mm

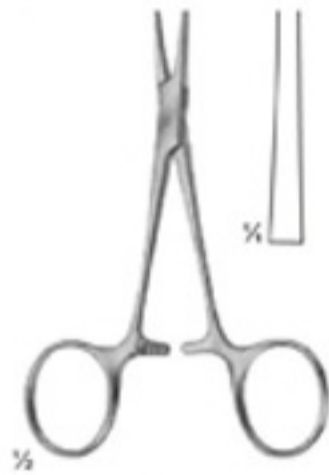

04-369
BABY-ALLIS
4 x 5 teeth
130 mm



04-370
BOYS-ALLIS
5 x 6 teeth
155 mm

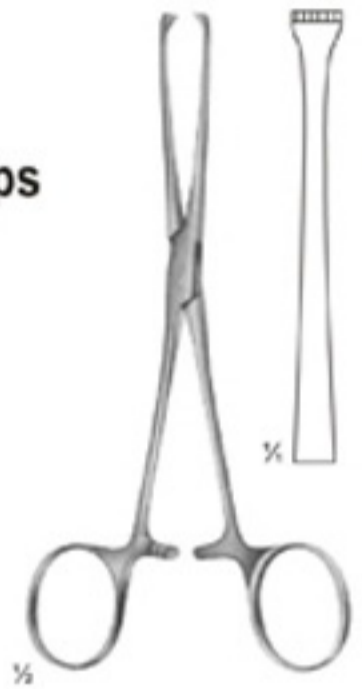

04-371
ALLIS
5 x 6 teeth
155 mm



04-372
LAHEY
135 mm

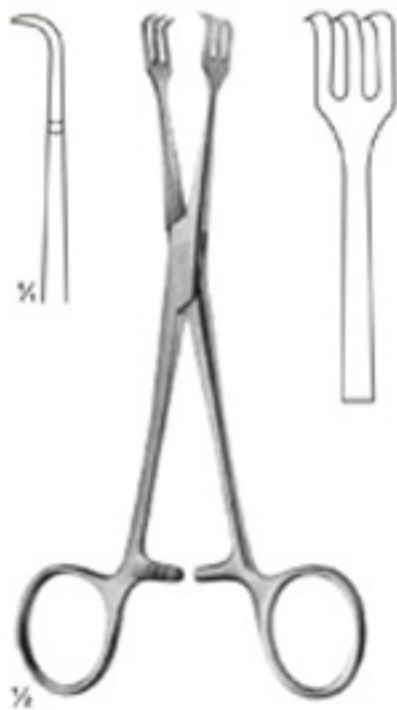

04-373
LAHEY
135 mm

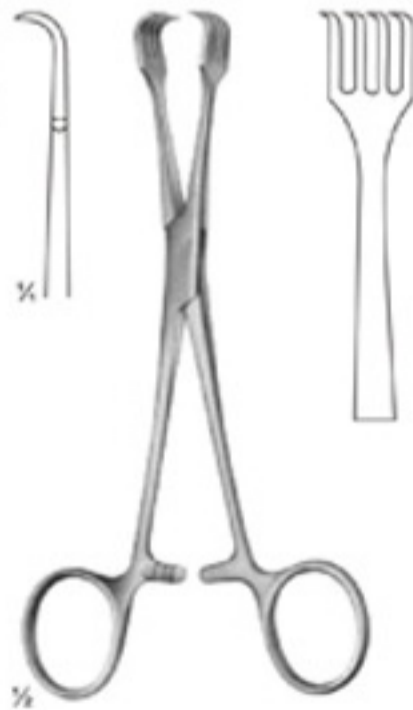

04-374
BRAUN
155 mm

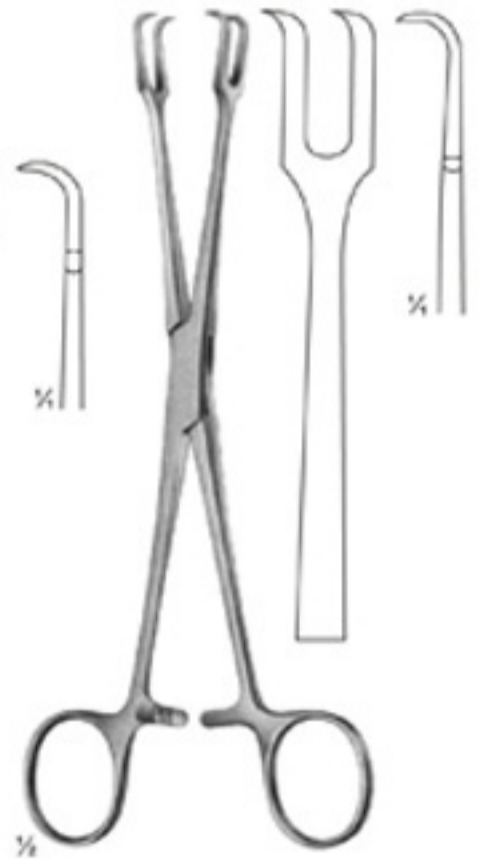

04-375
MUSEUX
200 mm

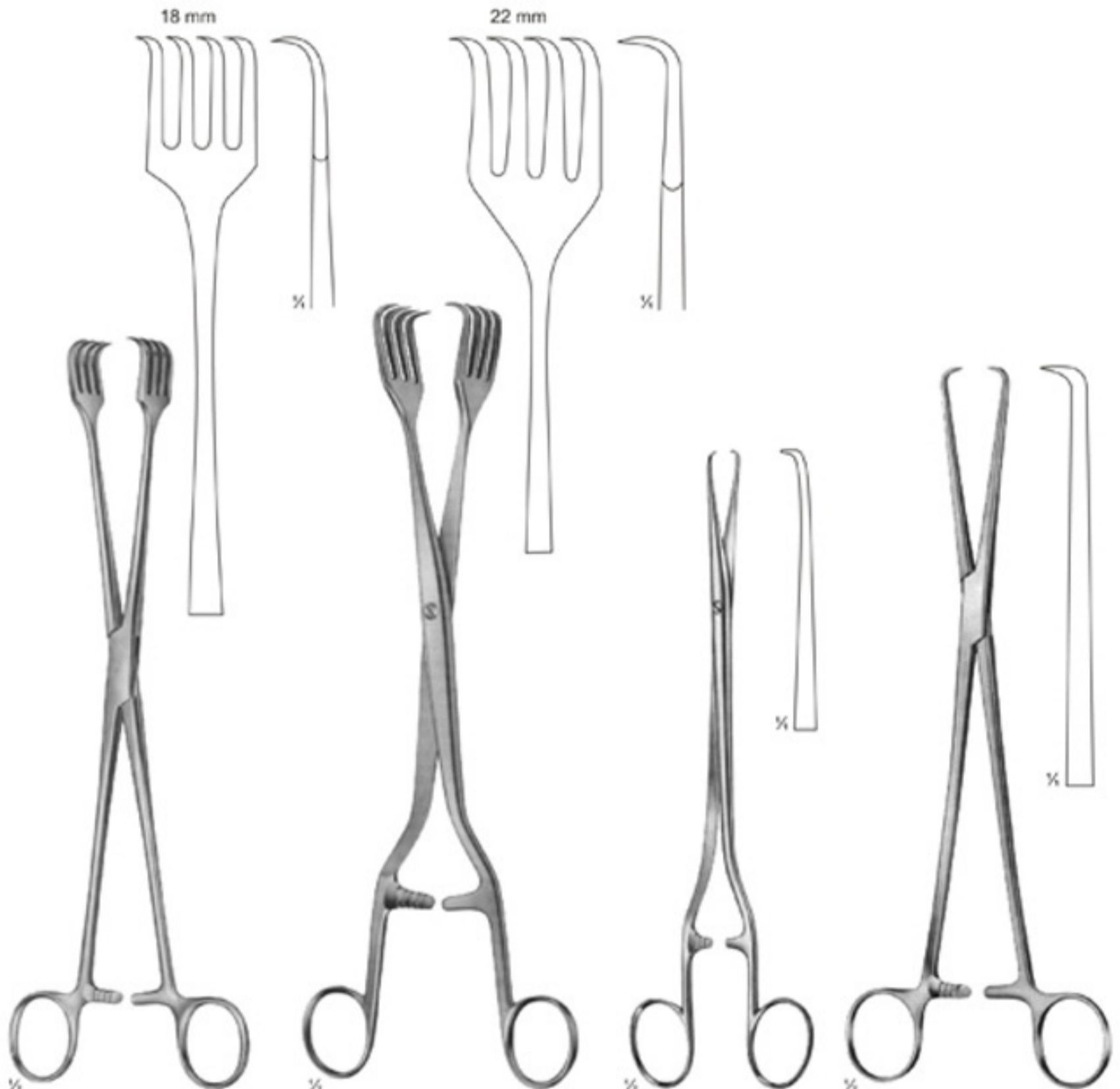

04-376
AESCULAP
260 mm

04-377
PRATT
270 mm

04-378
TIEMANN
Bullet forceps
220 mm

04-379
SCHRODER
250 mm



05-101
JONES
85 mm

05-102
ENGL. MOD.
85 mm

05-103 - 104
SCHAEDEL
85 mm

05-105
DOYEN
110 mm

05-106
DOYEN
180 mm

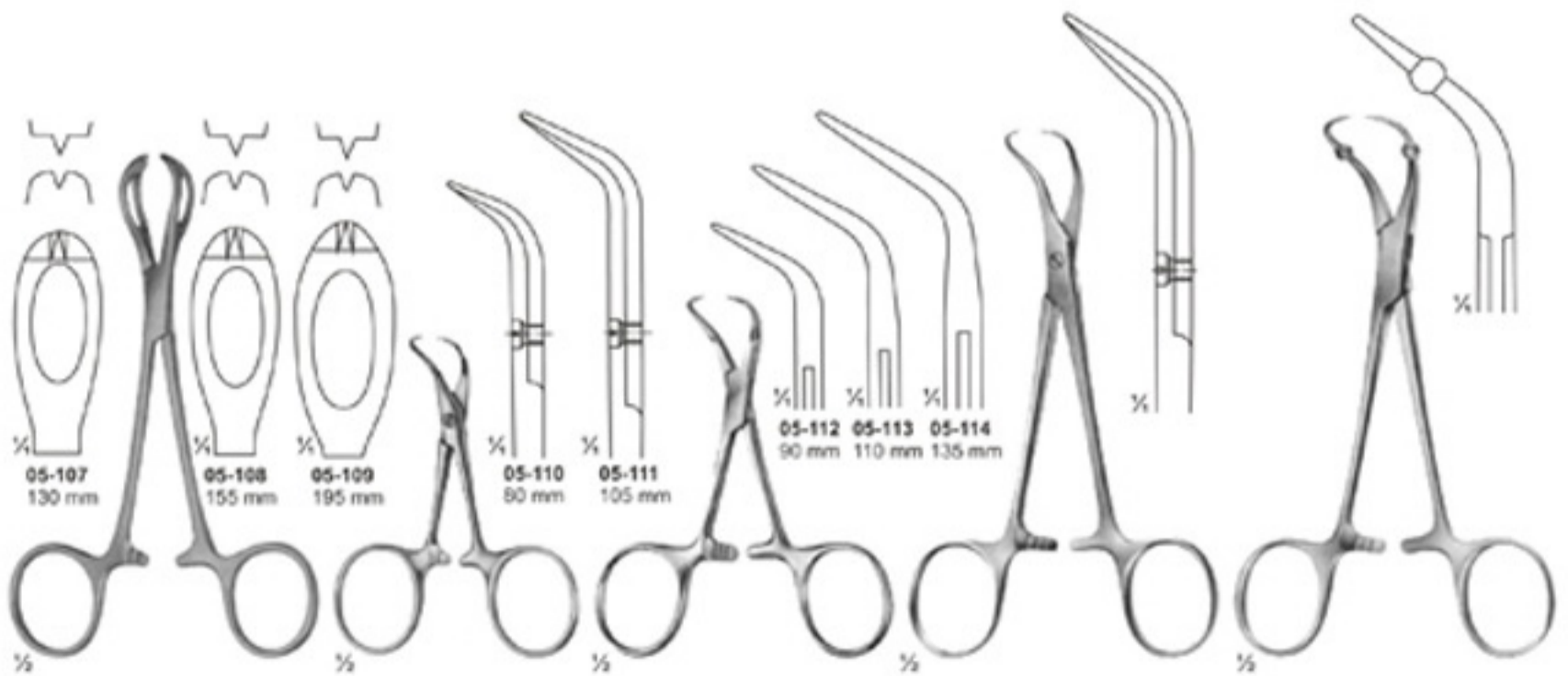

05-107
130 mm

05-108
155 mm

05-109
195 mm

05-110
80 mm

05-111
105 mm

05-112 05-113 05-114
90 mm 110 mm 135 mm

05-115
135 mm

05-116
135 mm

05-107 - 109
LANE

05-110 - 111
BACKHAUS

05-112 - 114
BACKHAUS

05-115
BACKHAUS-KOCHER
135 mm

05-116
ROEDER
135 mm



05-117
ROBIN
 with holders for tubing
 up to 13 mm
 135 mm



05-118
 with clip for tubing
 up to 15 mm
 110 mm



05-119
LORNA
 non perforating
 130 mm



05-120
 for paper cloths
 140 mm



05-121
BUNT
 105 mm



05-122
MAYO
 140 mm

Closing force

05-123 Straight 80g / 50g

05-124 Curved 80g / 50g

05-125 Curved tips 80g / 50g

05-126 Angled Shaped 80g / 50g

05-127 Muller Knee-bent 80g / 50g

05-128 Muller Ligature Forceps 80g / 50g

05-129 35 mm

05-130 35 mm

05-131 45 mm

05-132 45 mm

05-133 38 mm

05-134 48 mm

05-135 38 mm

05-136 48 mm

05-137 58 mm

05-138 58 mm

05-139 - 145 38 mm, 48 mm, 56 mm, 63 mm, 70 mm, 80 mm, 90 mm

05-146 DE BAKEY-HESS 20 mm

05-147 DE BAKEY Length 50 mm, Jaws 27 mm

05-148 DE BAKEY Length 48 mm, Jaws 27 mm

05-149 GLOVER Length 57 mm, Jaws 35 mm

05-150 DE BAKEY Length 73 mm, Jaws 38 mm

05-151 DE BAKEY Length 99 mm, Jaws 63 mm

05-152 DE BAKEY Length 95 mm, Jaws 54 mm

05-153 L. 80 mm

05-154 L. 90 mm

05-155 L. 105 mm

05-156 L. 124 mm

05-157 L. 78 mm

05-158 L. 86 mm

05-159 L. 97 mm

05-160 L. 114 mm

05-161 GLOVER L. 68 mm

05-162 L. 96 mm

05-163 L. 117 mm

05-164 GLOVER L. 65 mm

05-165 L. 91 mm

05-166 L. 110 mm

Jaw, cross serrated



06-101
CARREL
85 mm

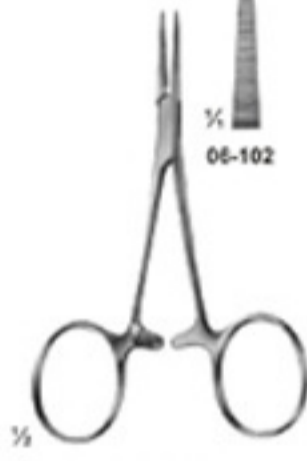

06-102 - 105
BABY-MOSQUITO
(HARTMANN)
100 mm

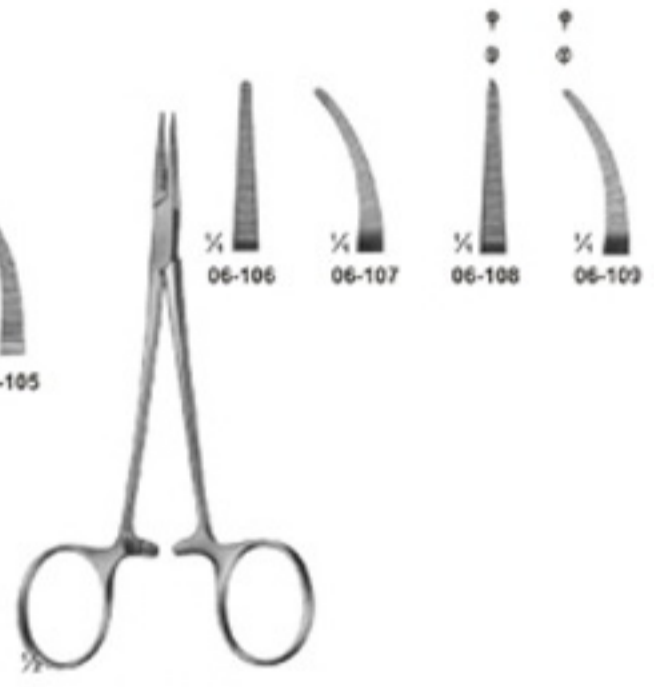

06-106 - 109
MICRO-HALSTED
125 mm



06-110 - 113
HALSTED-MOSQUITO
125 mm

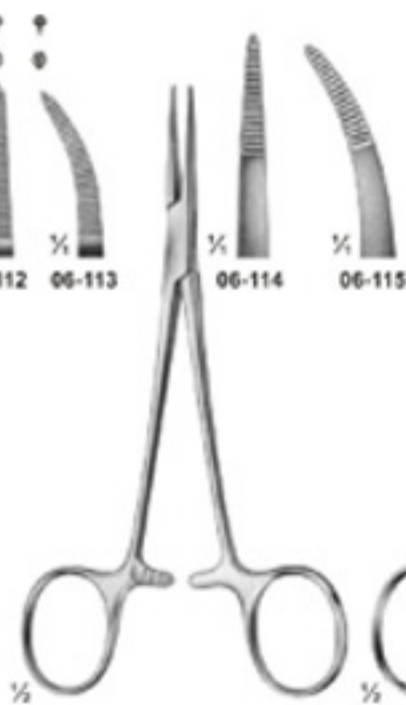

06-114 - 115
PROVIDENCE-HOSPITAL
140 mm



06-116 - 117
KELLY
140 mm

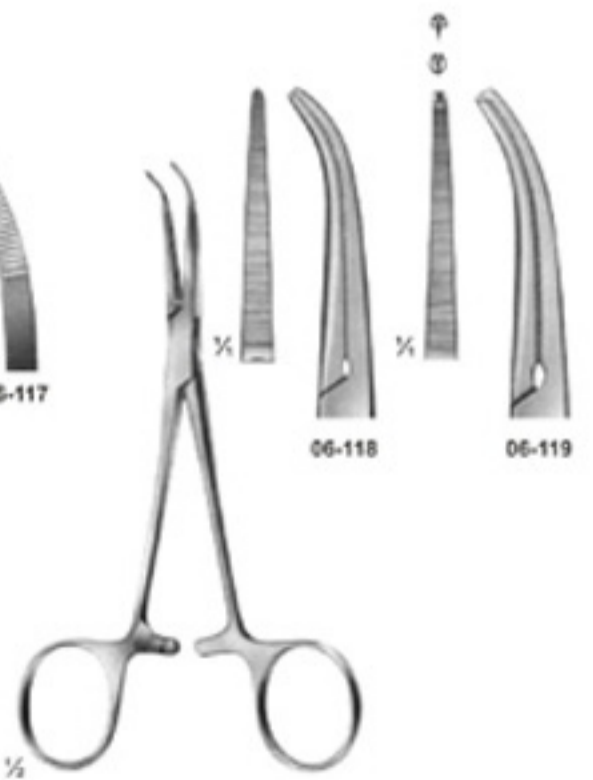

06-118 - 119
DANDY
Curved sideways
140 mm

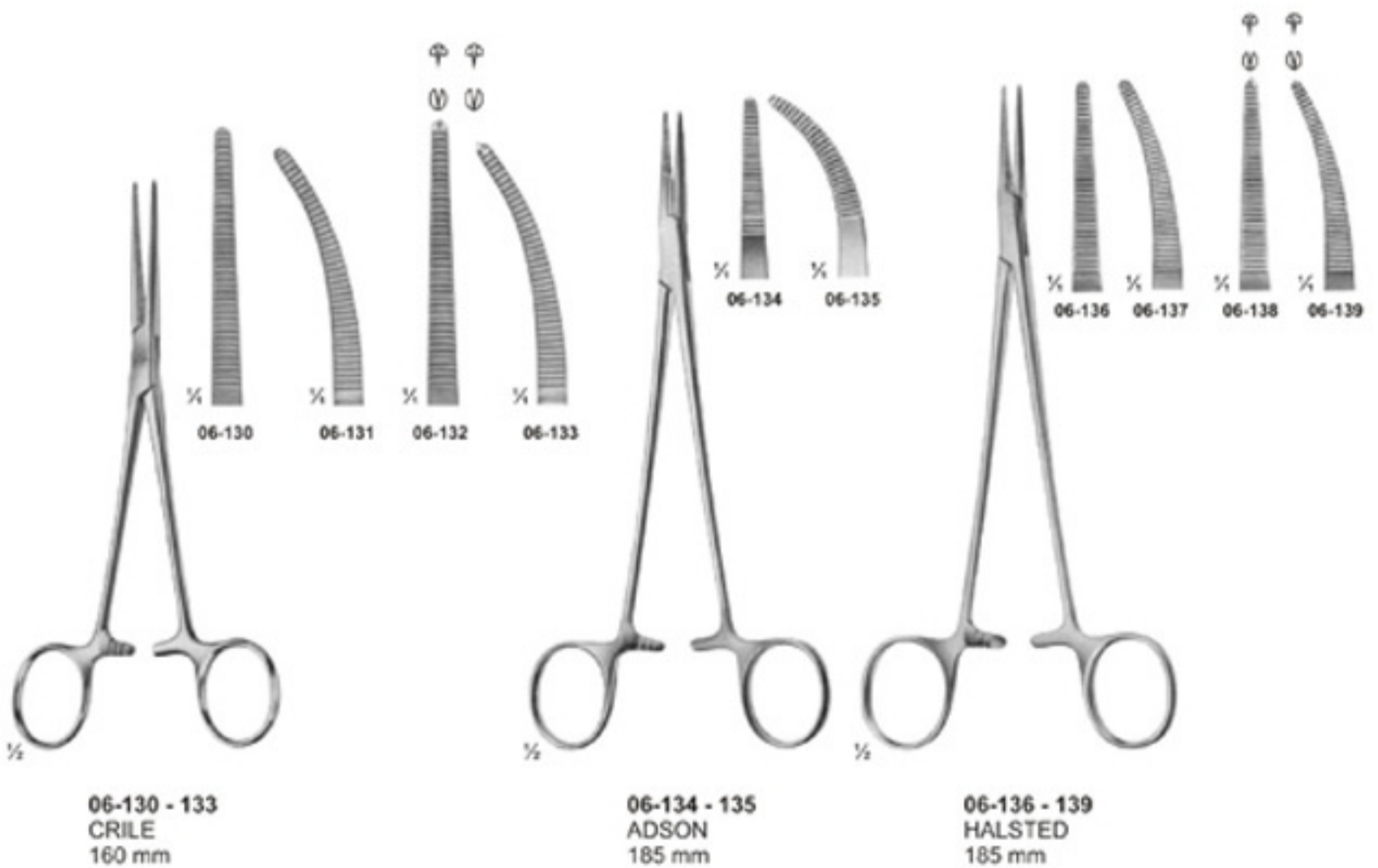
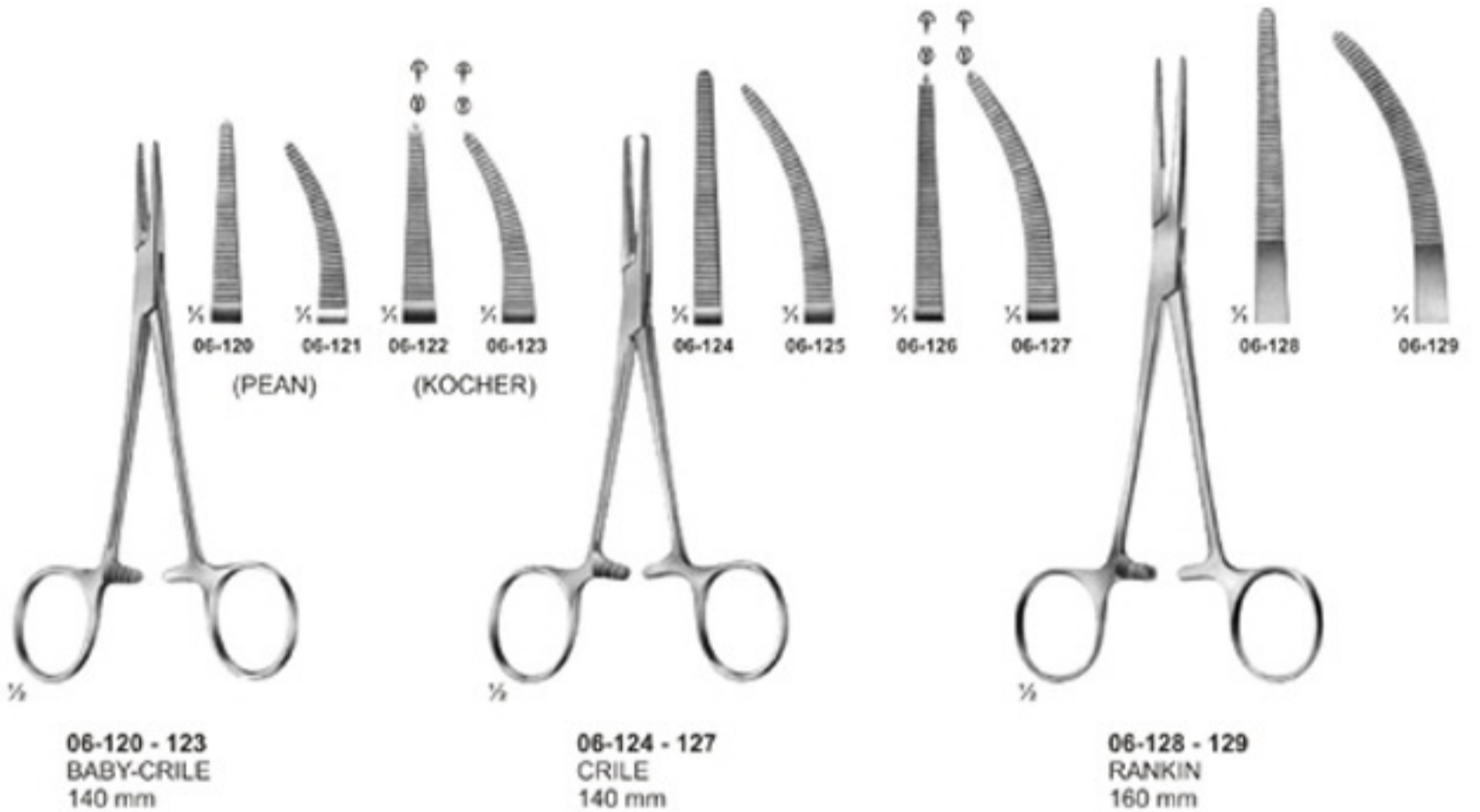

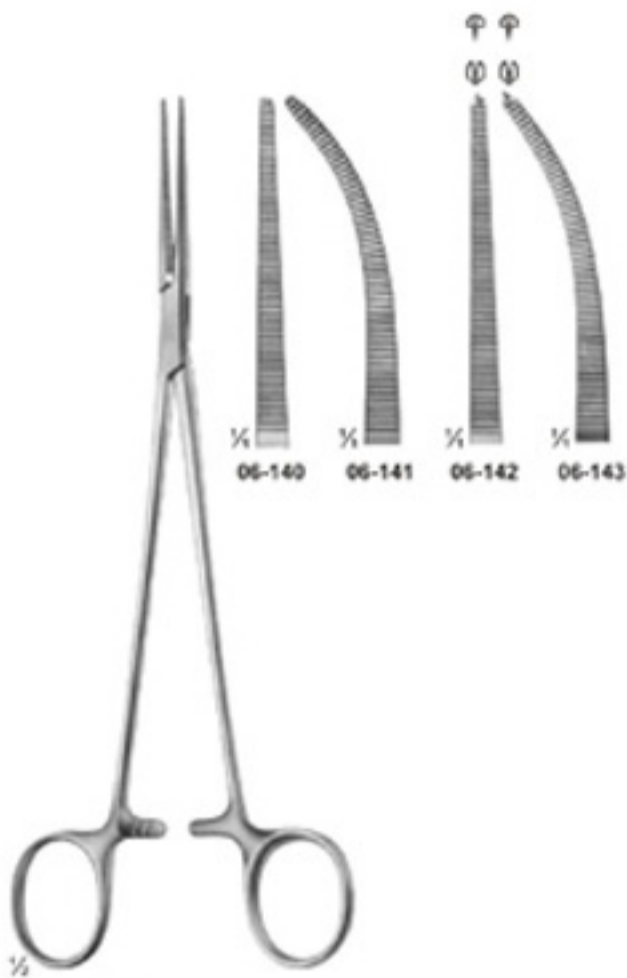

06-140 - 143
HALSTED-MOSQUITO
200 mm



06-144 - 148
HEISS
200 mm



06-149 - 150
HALSTED
215 mm

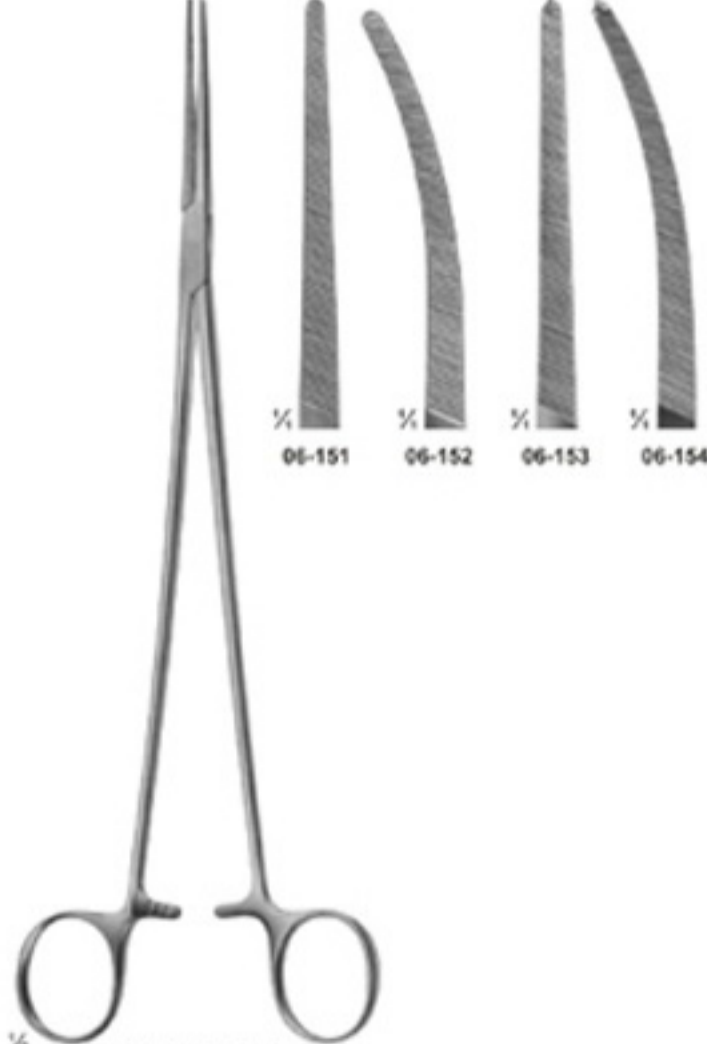

06-151 - 154
BENGOLEA
245 mm

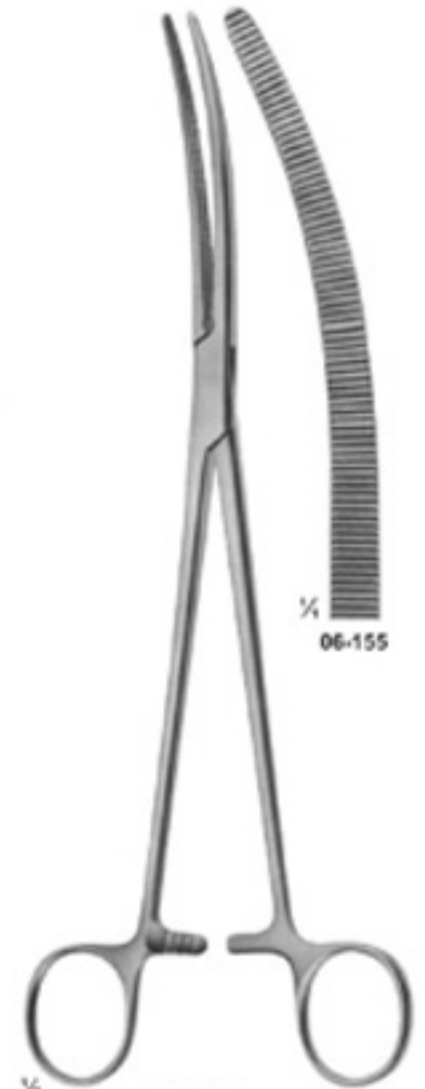

06-155
CRAFOORD
245 mm

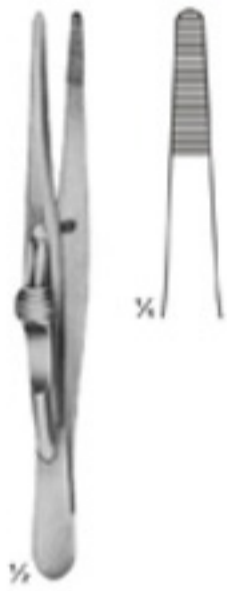

06-156
FRICKE
Artery forceps
130 mm



06-157
KRONLEIN
130 mm



06-158
PEAN
125 mm



06-159 - 160
PEAN



06-161
PEAN

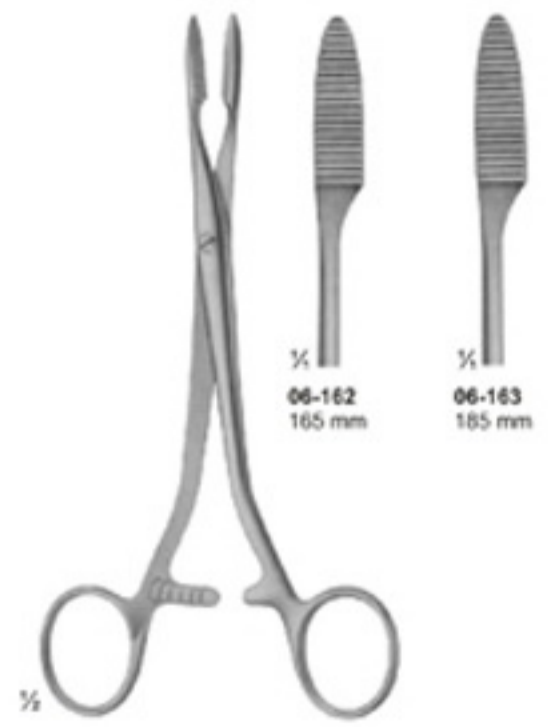

06-162 - 163
PEAN

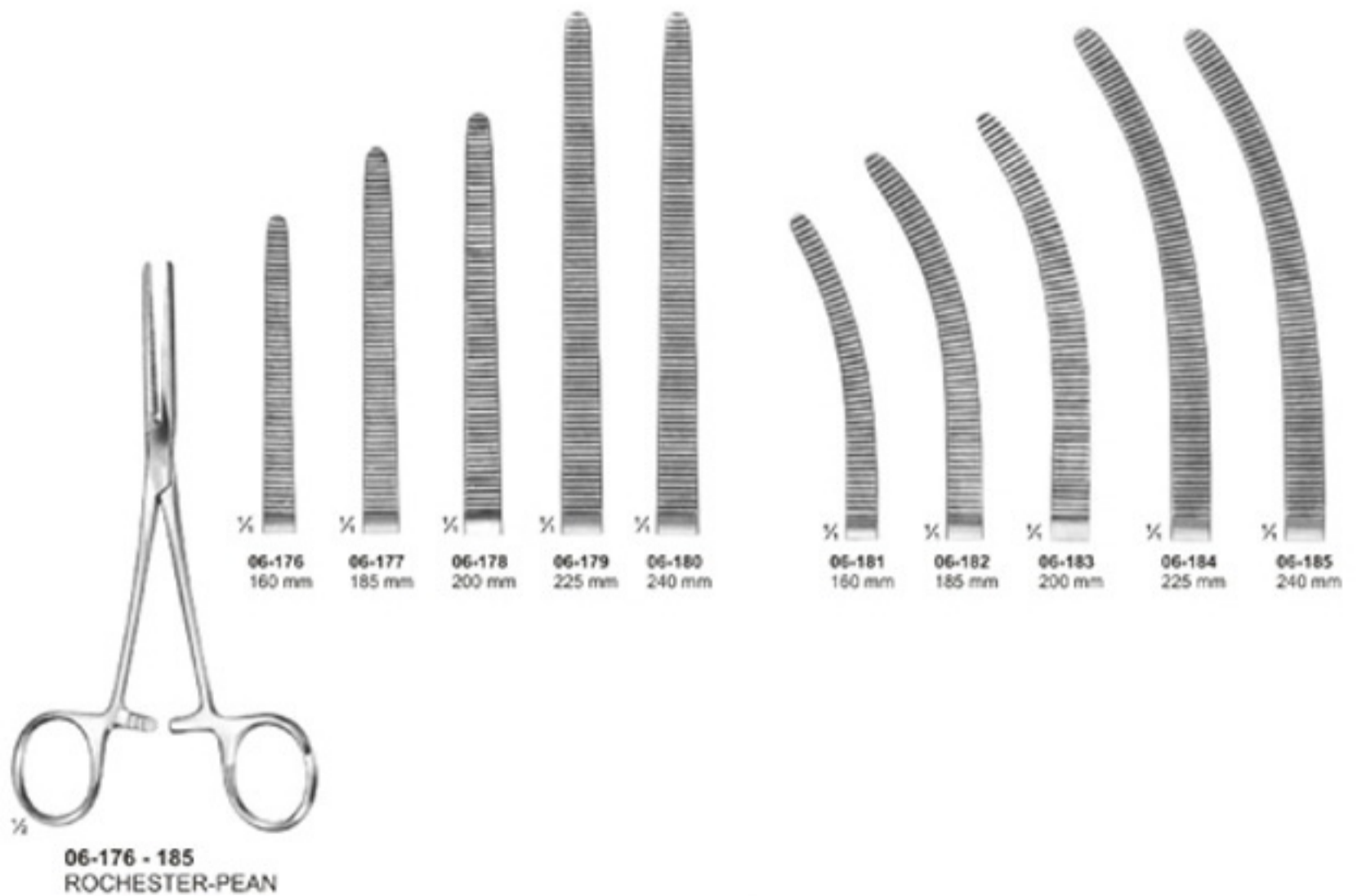
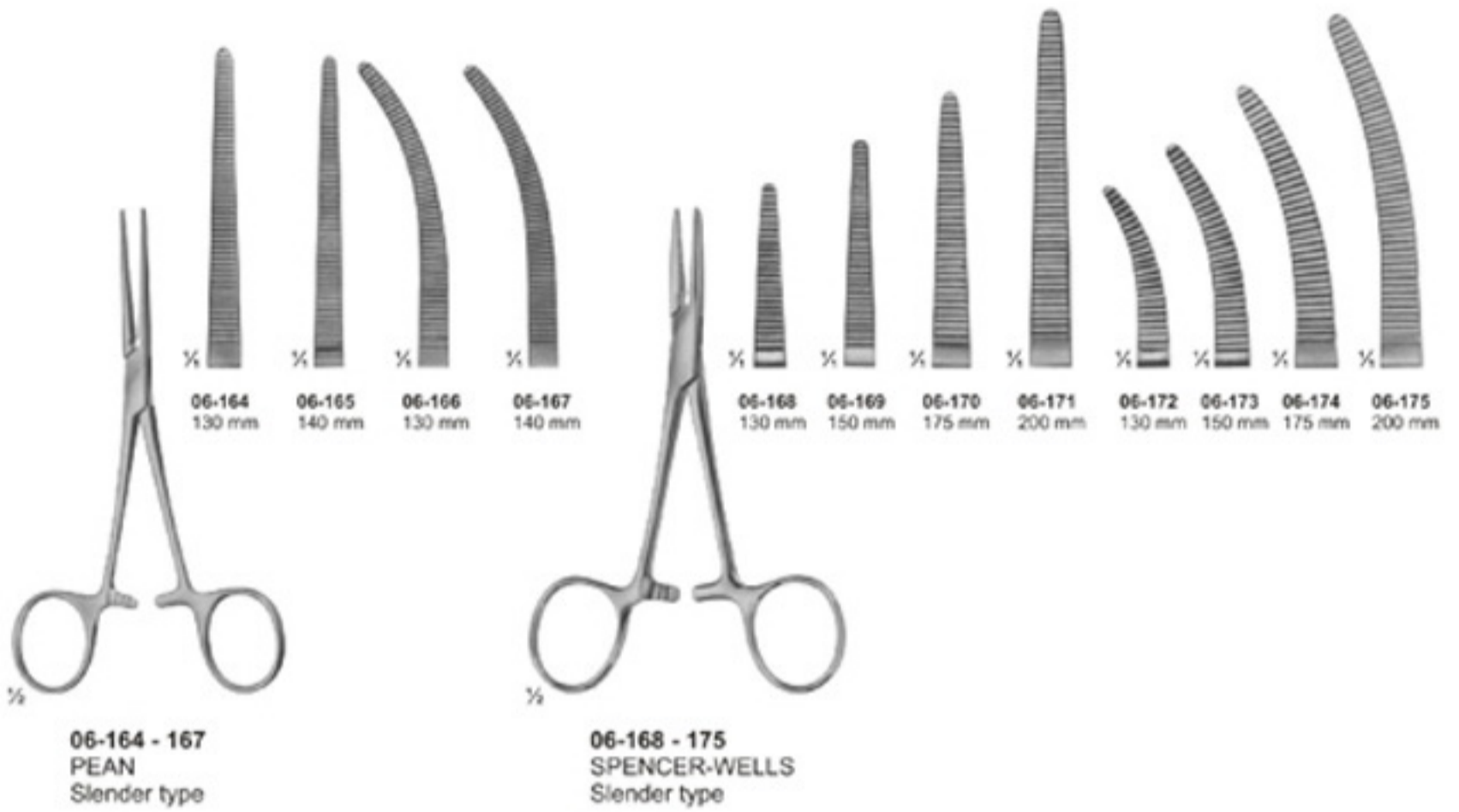



06-186 - 191
PEAN

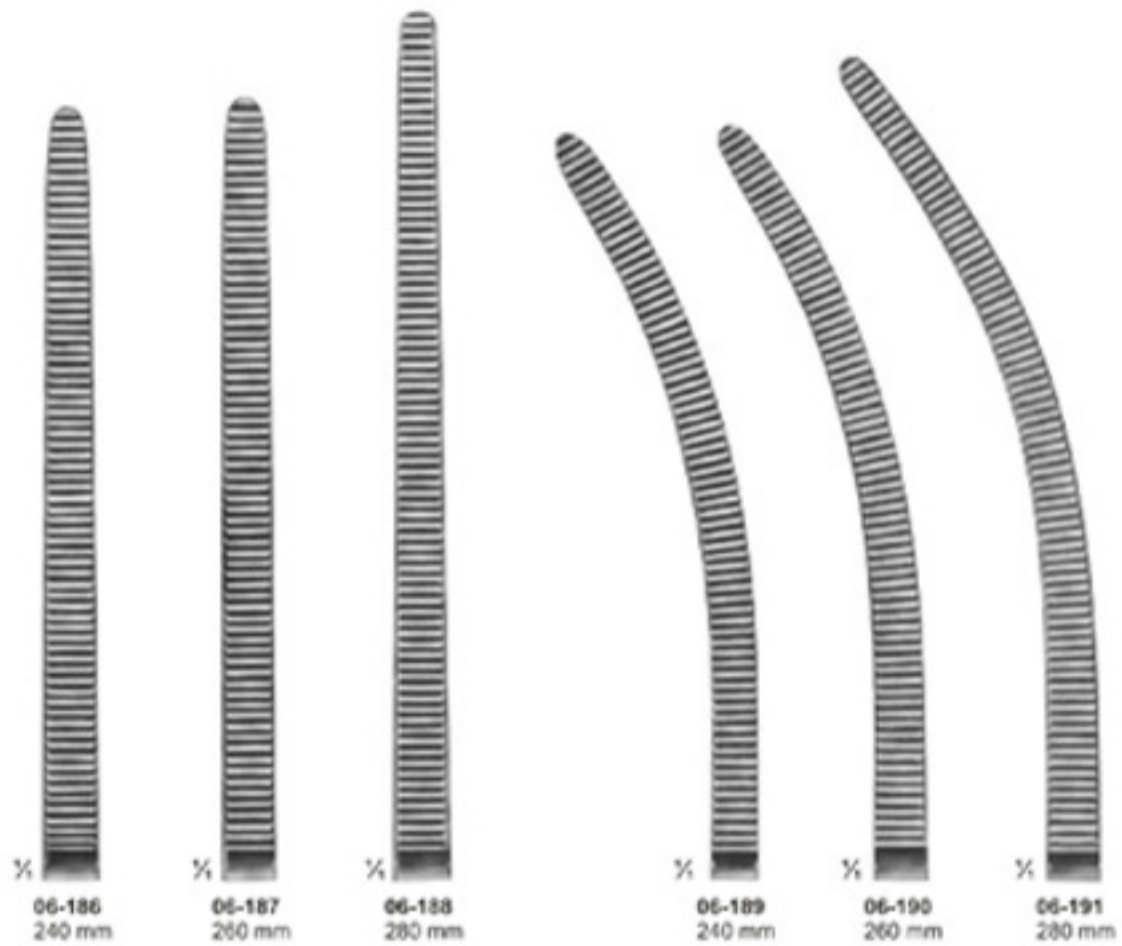

06-192
KOCHER
Strong Pattern
145 mm

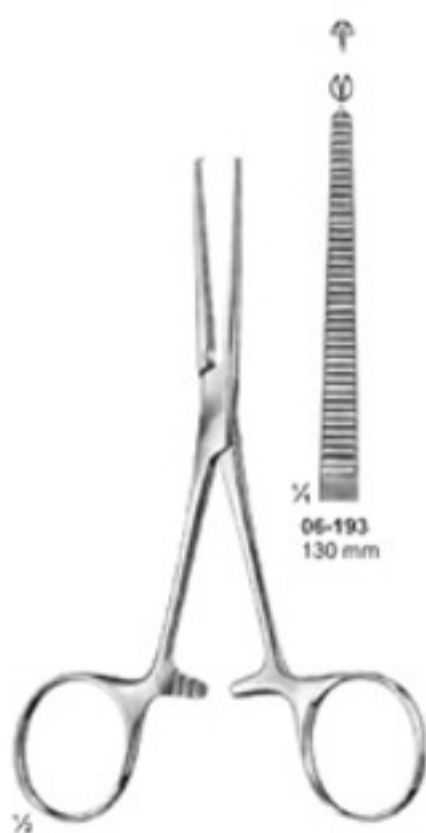

06-193 - 195
KOCHER

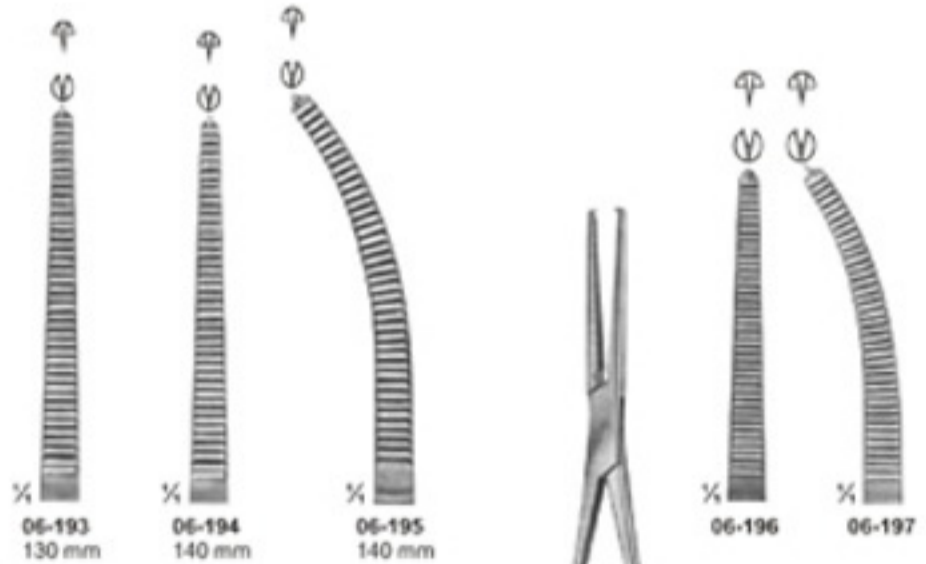

06-196 - 197
ROCHESTER-UCHSNER
140 mm

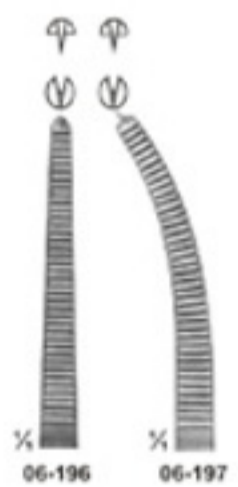

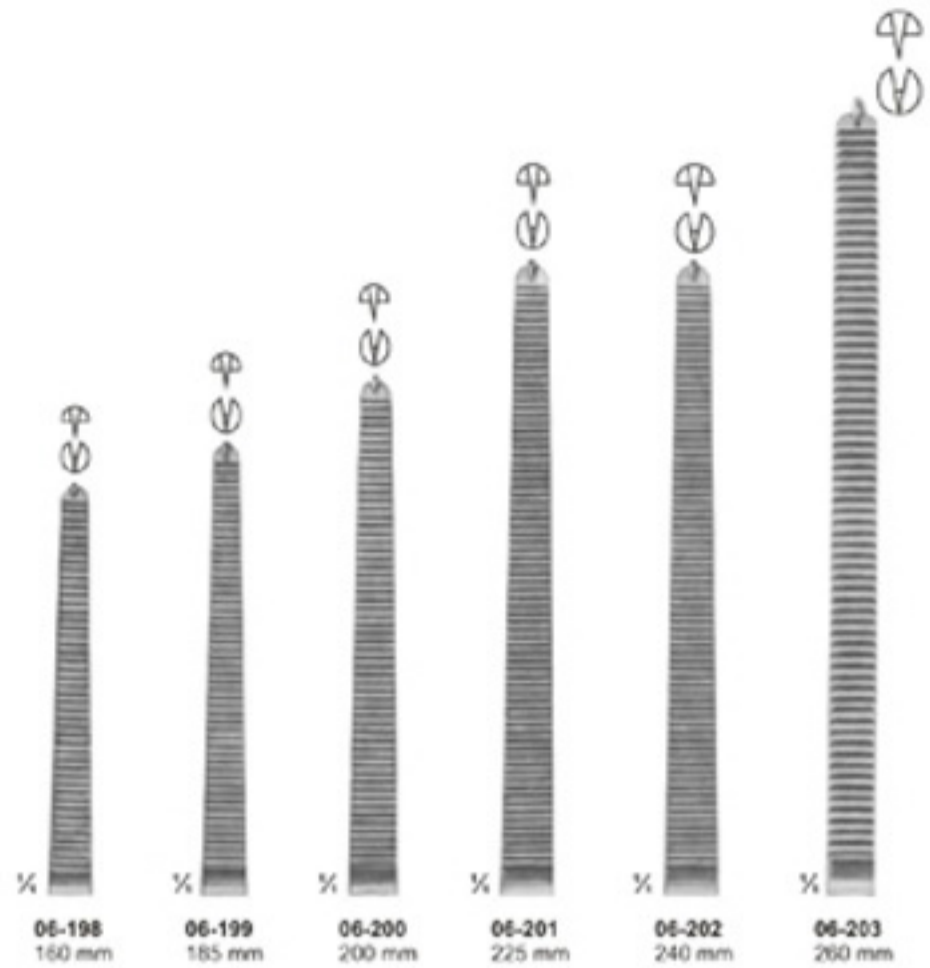

06-198 - 209
KOCHER-OCHSNER

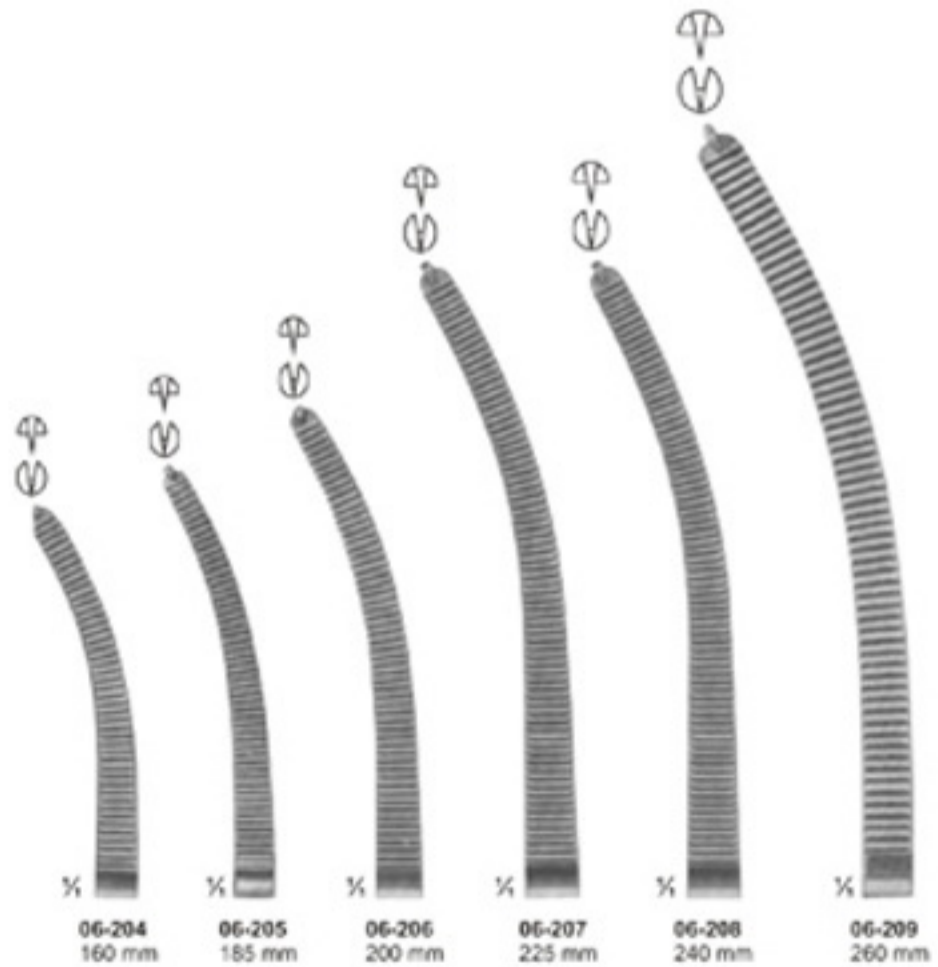

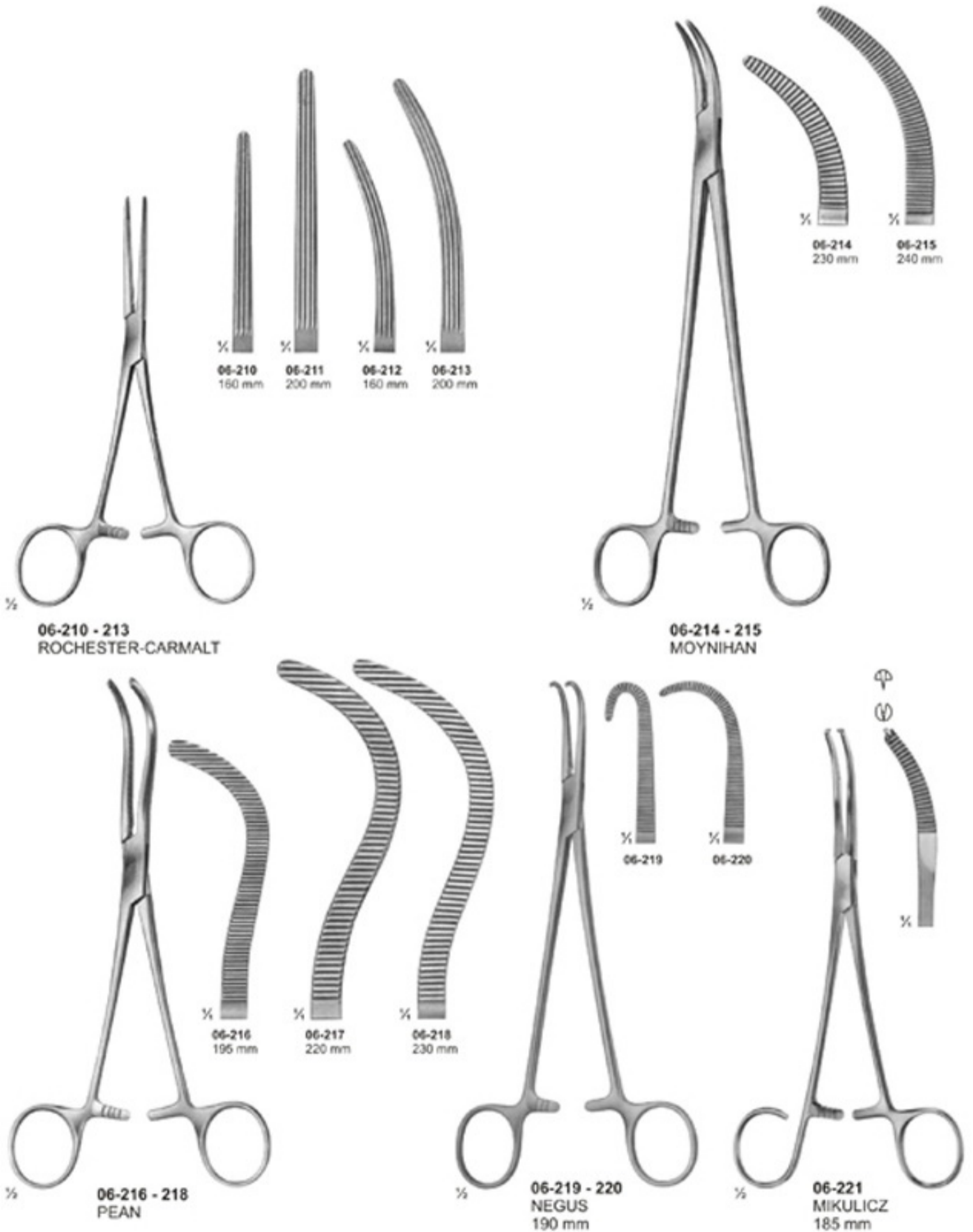



06-222
MICRO-ADSON
140 mm



06-223
BABY-OVERHOLT
135 mm

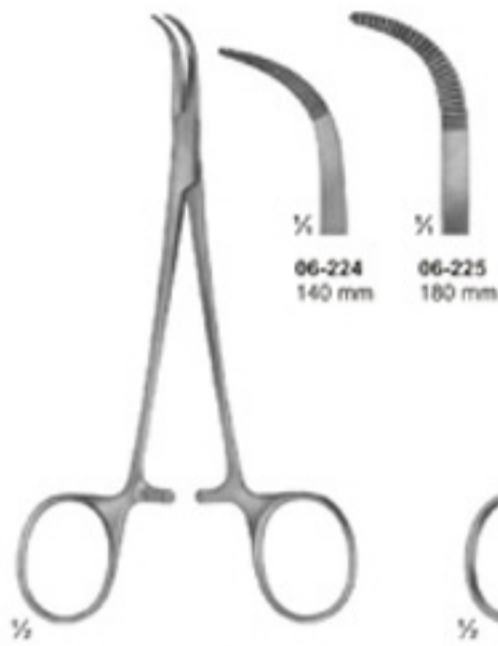

06-224 - 225
BABY-MIXTER

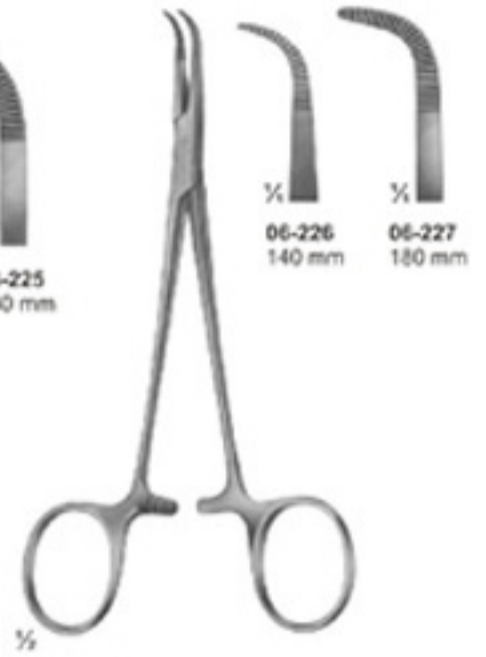

06-226 - 227
BABY-ADSON

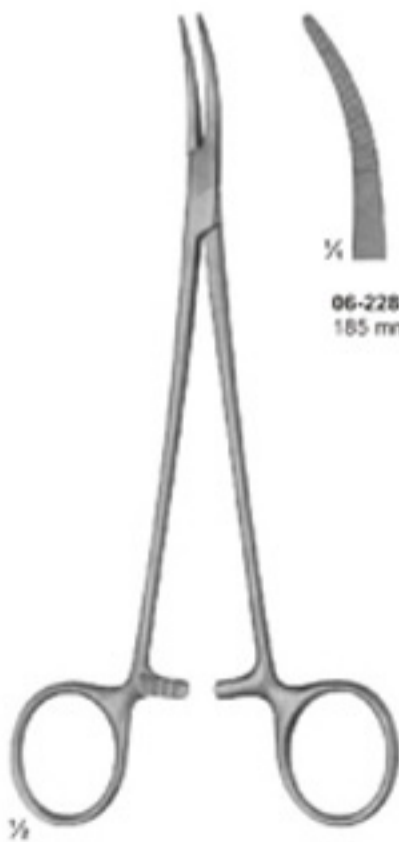

06-228
NISSEN



06-229 - 230
YASARGIL
195 mm

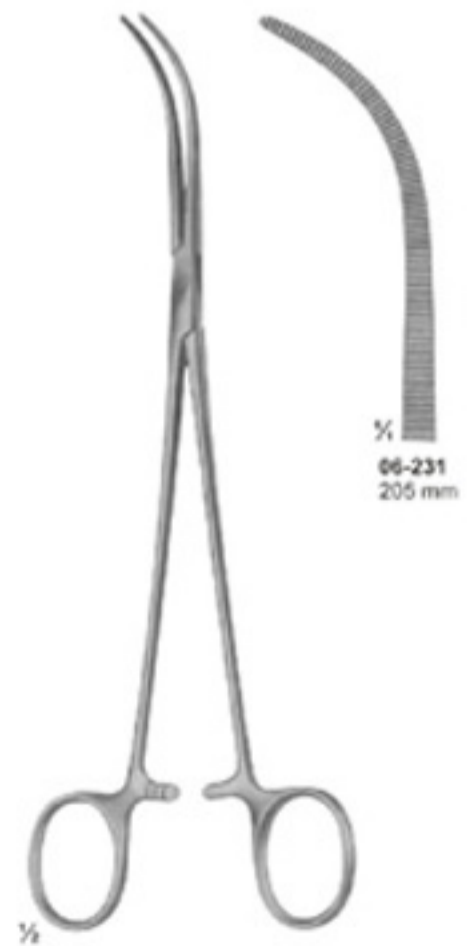

06-231
OVERHOLT-MIXTER



06-232 - 243
OVERHOLT-GEISSENDOERFER

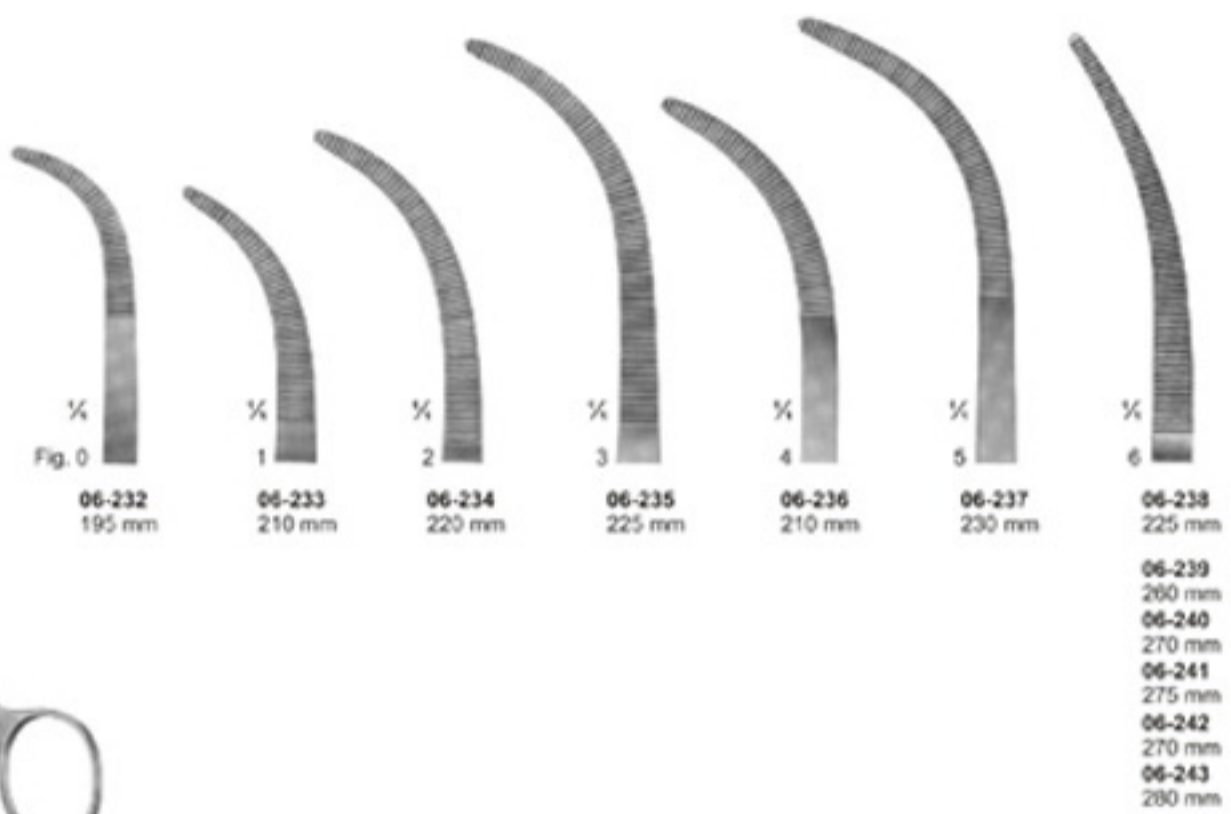

06-244 - 251
OVERHOLT
fine pattern

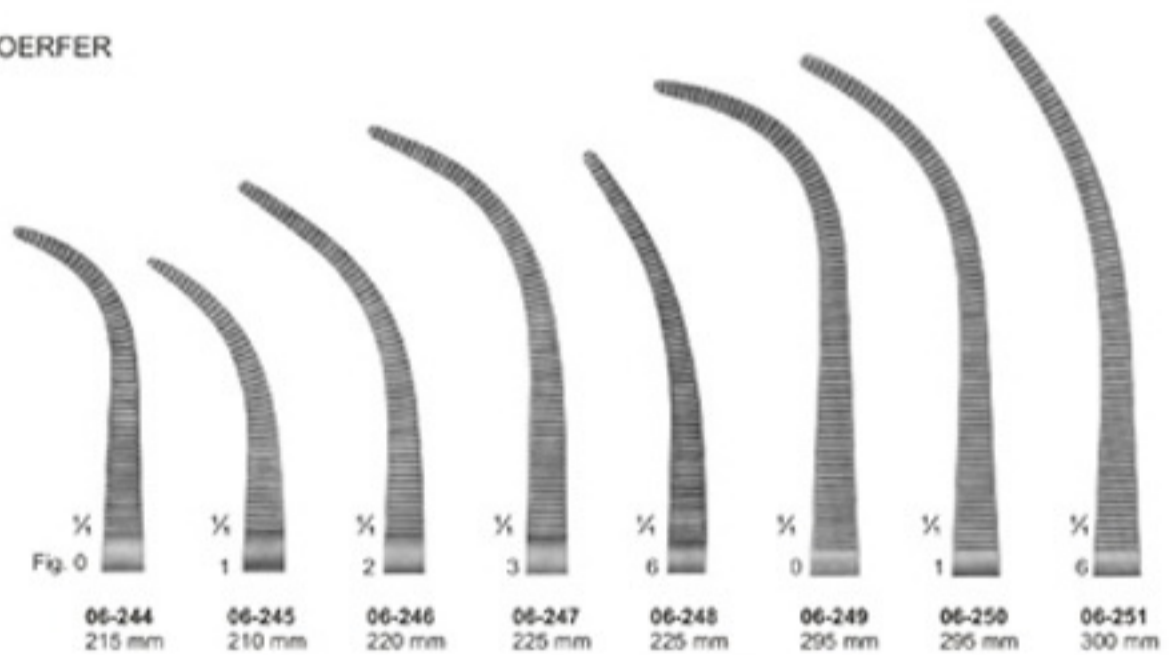



06-252
MIXTER-O'SHAUGHNESSY
190 mm



06-253
HEISS
195 mm

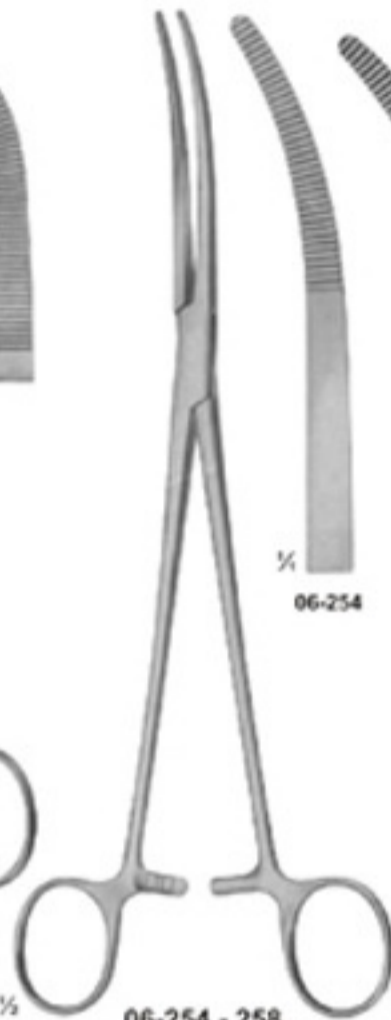

06-254 - 258
RUMEL
240 mm

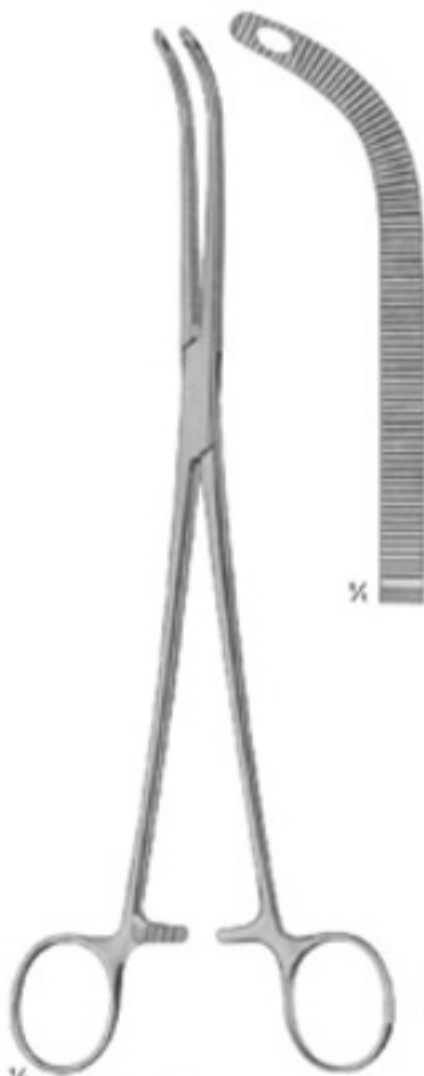

06-259
FINOCHIETTO
245 mm



06-260
MIXTER
230 mm



06-261
LAWRENCE
270 mm



06-262 - 263
ZENKER

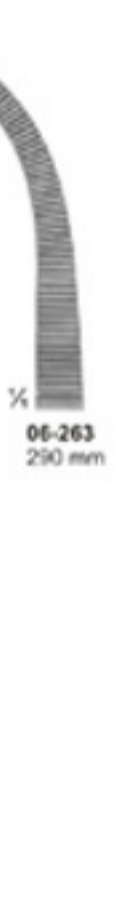

06-263
290 mm

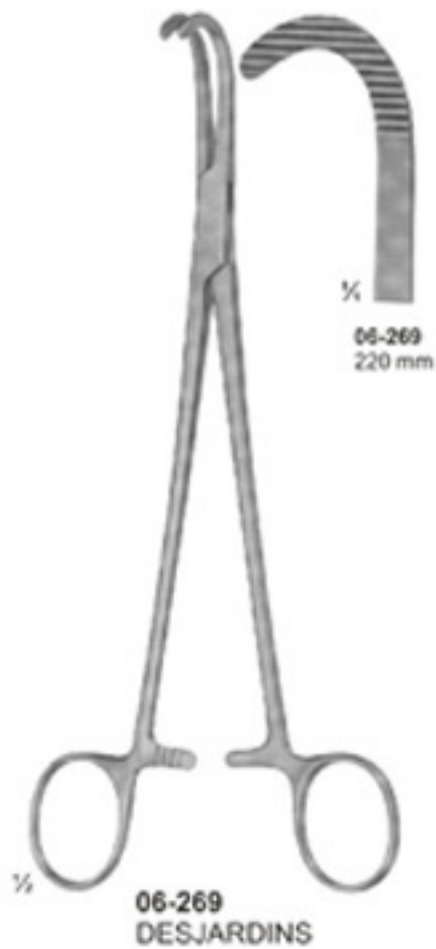
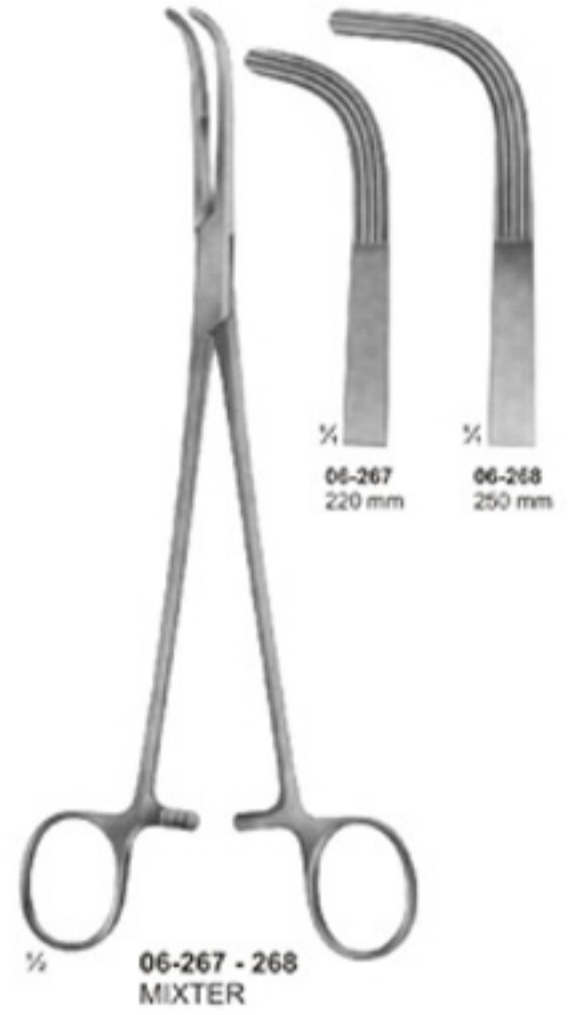



06-272
BABY-MIKULICZ
140 mm



06-273
MIKULICZ
185 mm

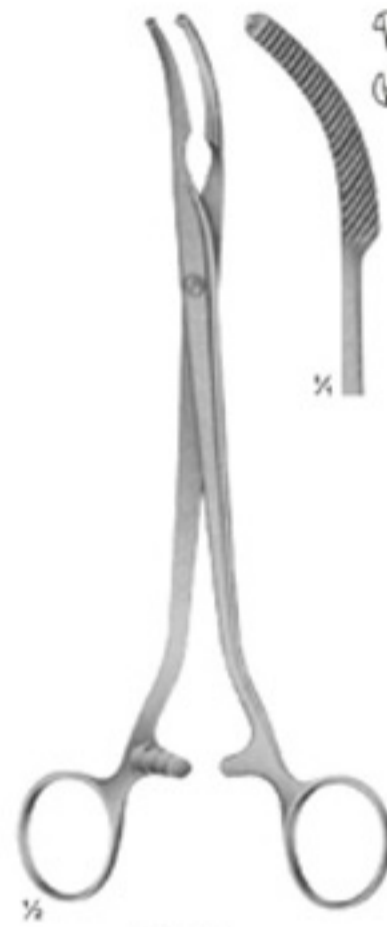

06-274
MIKULICZ
205 mm

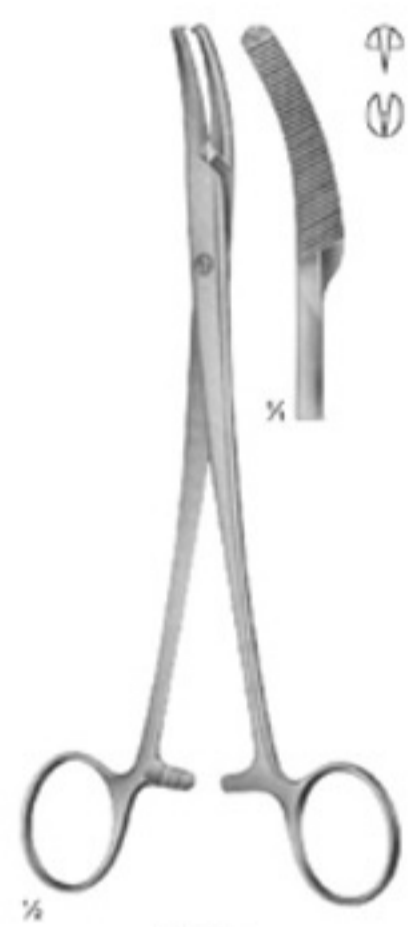

06-275
MIKULICZ
200 mm



06-276
MIKULICZ
205 mm

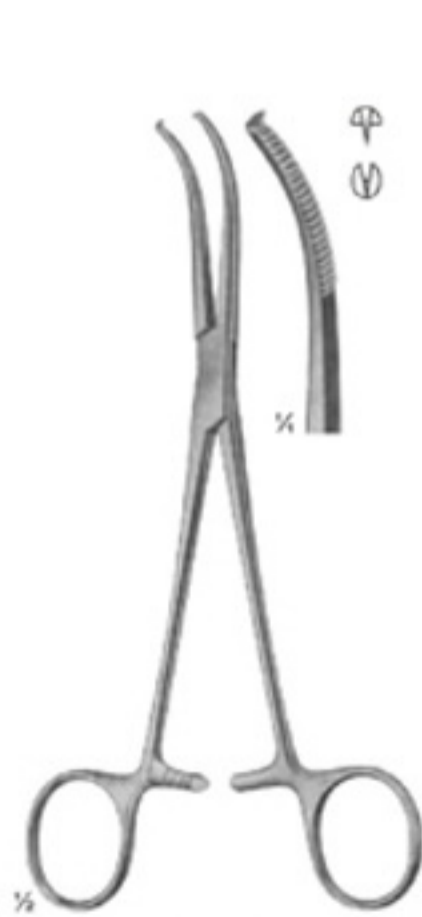

06-277
MIKULICZ
185 mm

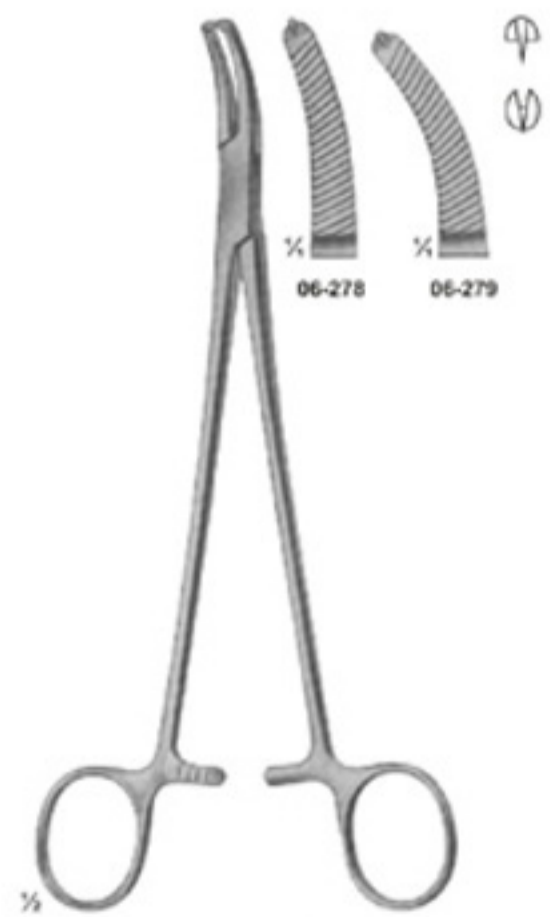

06-278 - 279
FAURE
205 mm



06-280 - 281
PHANEUF

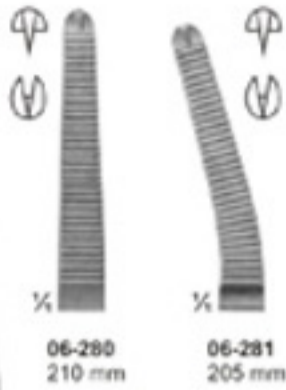

06-282 - 283
HEANEY modif.

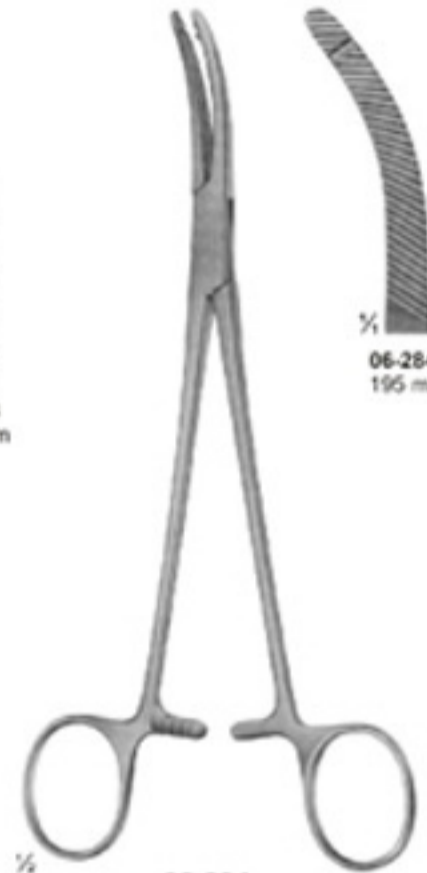
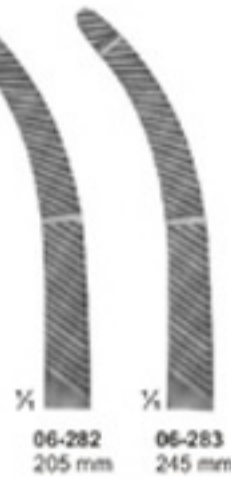

06-284
HEANEY

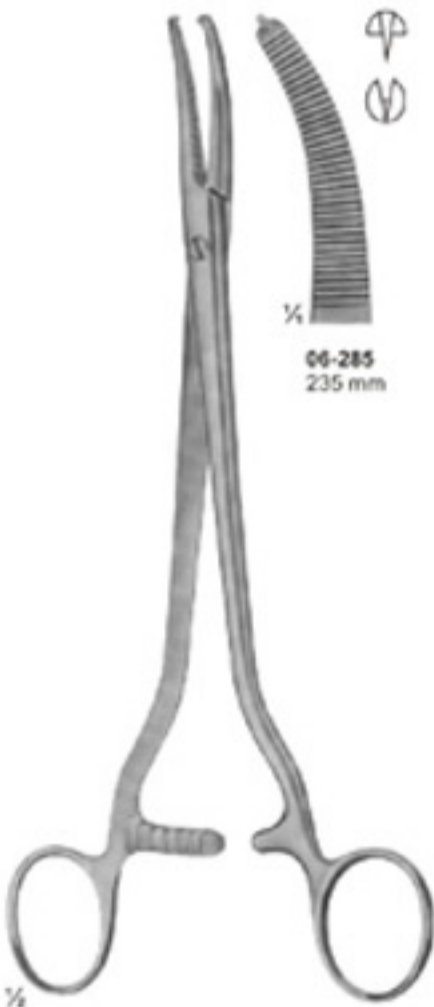

06-285
WERTHEIM



06-286
WERTHEIM



06-287
WERTHEIM



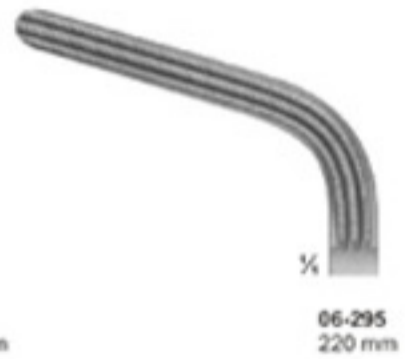
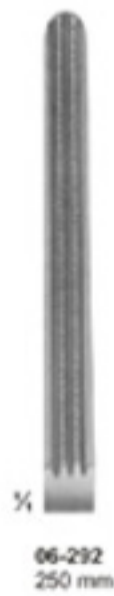
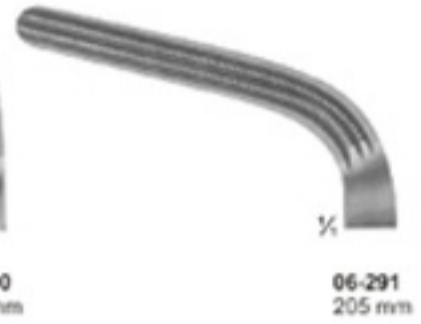



06-296
WERTHEIM
Hysterectomy Forceps
255 mm

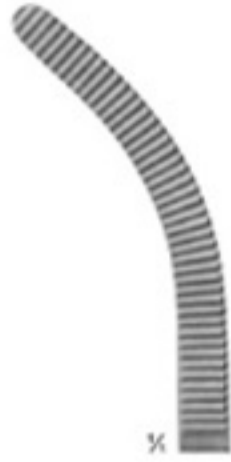

¼



06-297
WERTHEIM
Parametrium Clamp
260 mm



¼



06-298 - 300
DICK



¼

06-298
255 mm

06-299
285 mm

06-300
275 mm

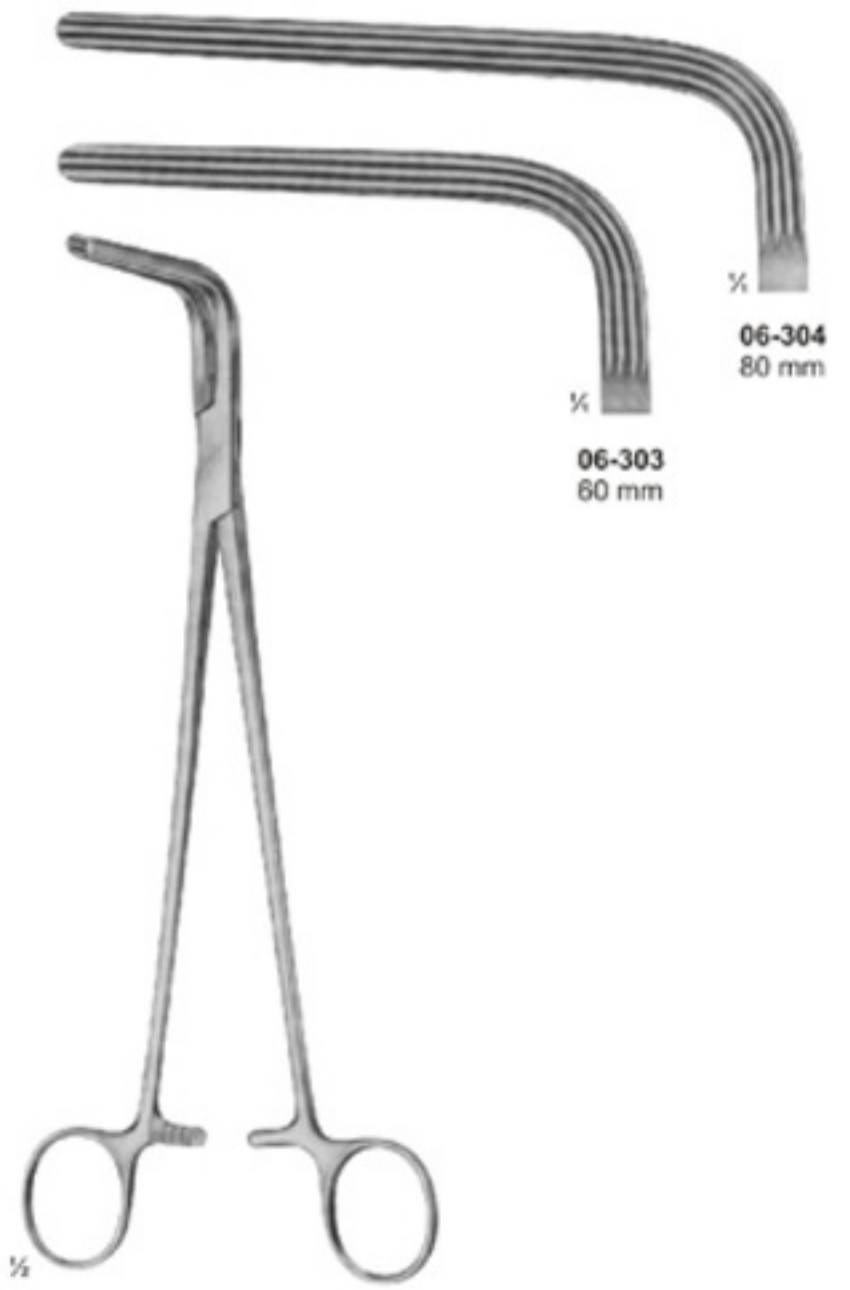

06-303 - 304
230 mm



07-101
ROHRSCHEIDER
With copper inserts
100 mm



07-102
KALT
With catch
135 mm



07-103
ARRUGA
With catch
135 mm



07-104 - 105
CASTROVIEJO
With catch
145 mm



07-106 - 107
CASTROVIEJO
With Catch
160 mm



07-108 - 109
Without catch
185 mm



07-109



07-110 - 111
JACOBSON
185 mm



07-111
With catch



07-112
Without catch
195 mm



07-113 - 114
YASARGIL
With catch
200 mm



07-115 116
BARRAQUER
Without catch



07-117 - 118
BARRAQUER
Without catch
120 mm



07-119 - 120
BARRAQUER
With catch
120 mm



07-121 - 122
BARRAQUER
With Catch
150 mm

07-123
MULLER
With Locking
Mechanism
145 mm



07-124 - 125
BROCK
Without catch
150 mm



07-126 - 127
YASARGIL
200 mm



07-128 - 129
YASARGIL
225 mm



07-130
YASARGIL
245 mm



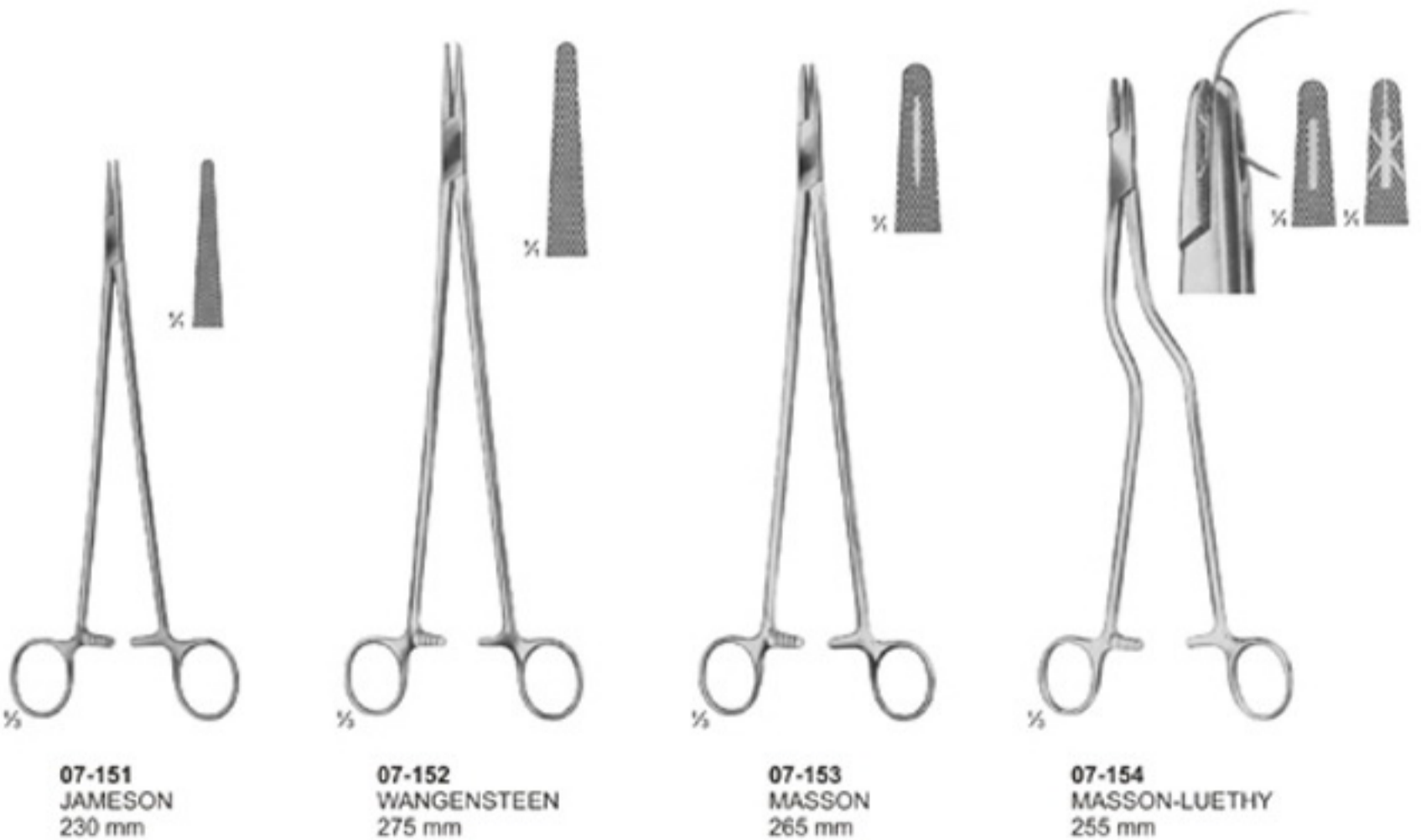

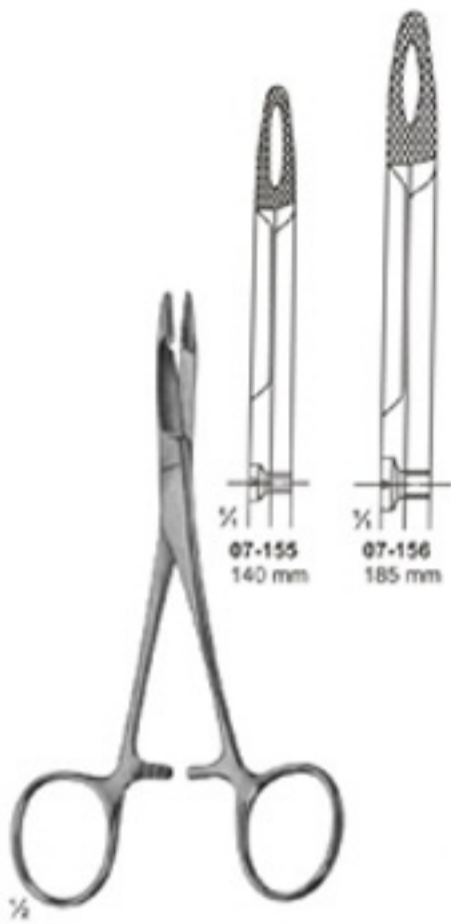

07-155 - 156
HEGAR-OLSEN
255 mm

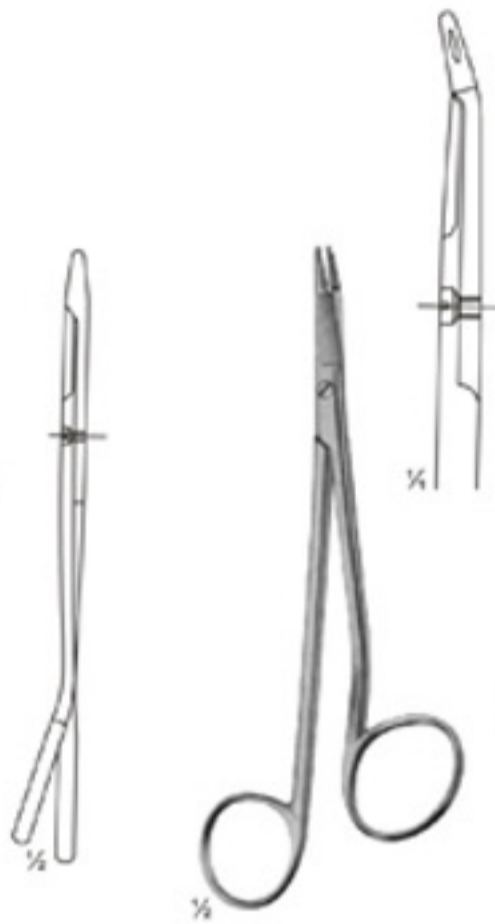

07-157
GILLIES
150 mm



07-158
GILLIES
160 mm



07-159
EISELSBERG
115 mm



07-160
SCHOEMAKER-LOTH
125 mm



07-161
CRILE
150 mm



07-162
TONNIS
Elastic pattern for
dura-or intestinal suture
180 mm

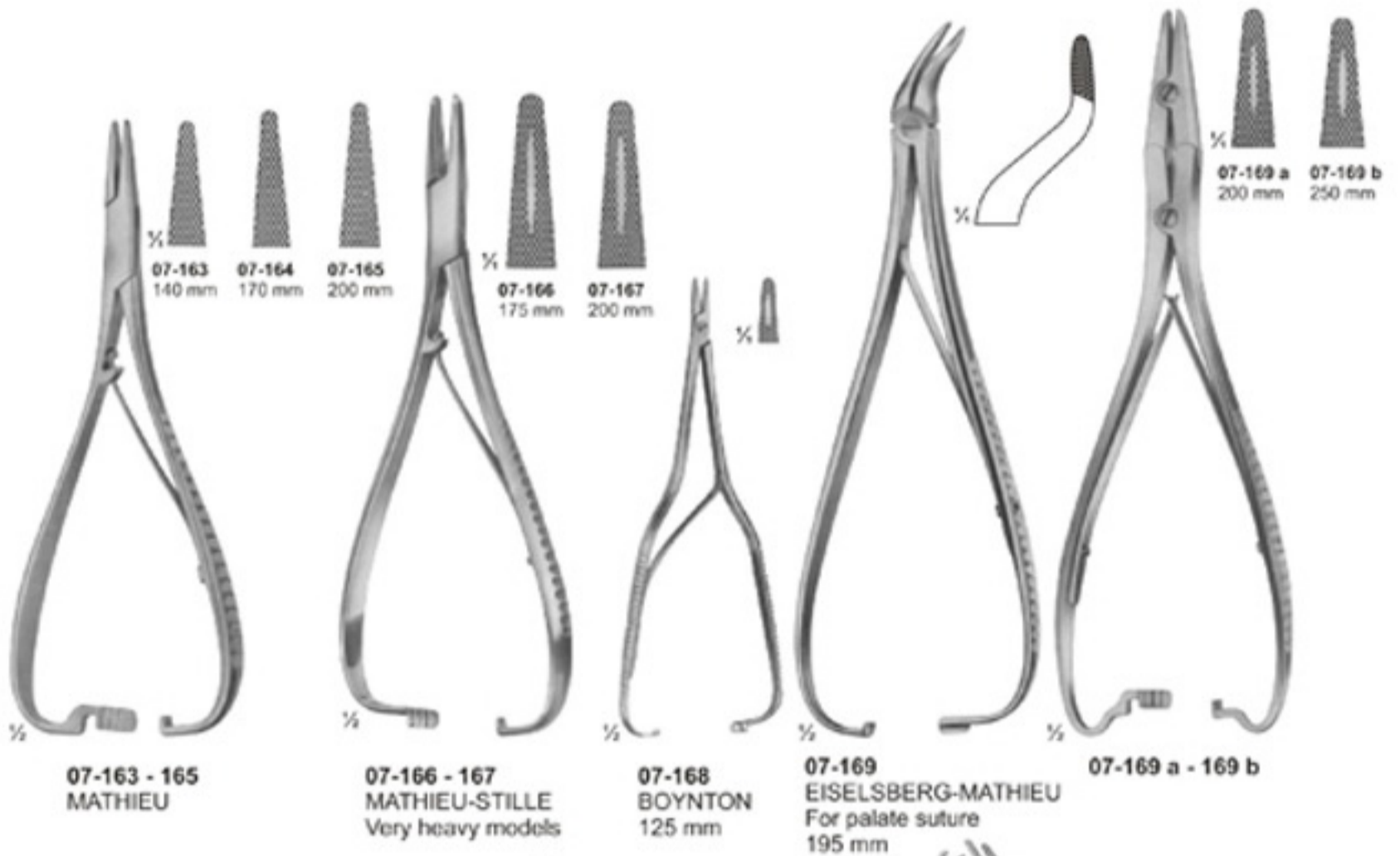

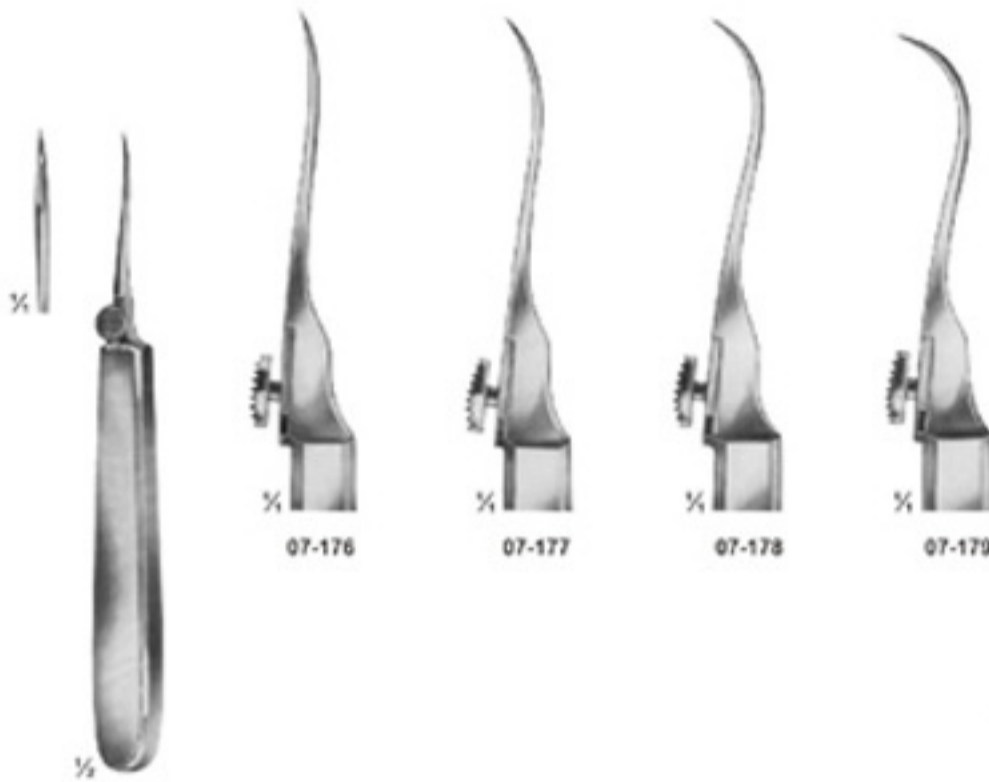

07-176

07-177

07-178

07-179

07-176 - 179
REVERDIN
140 mm

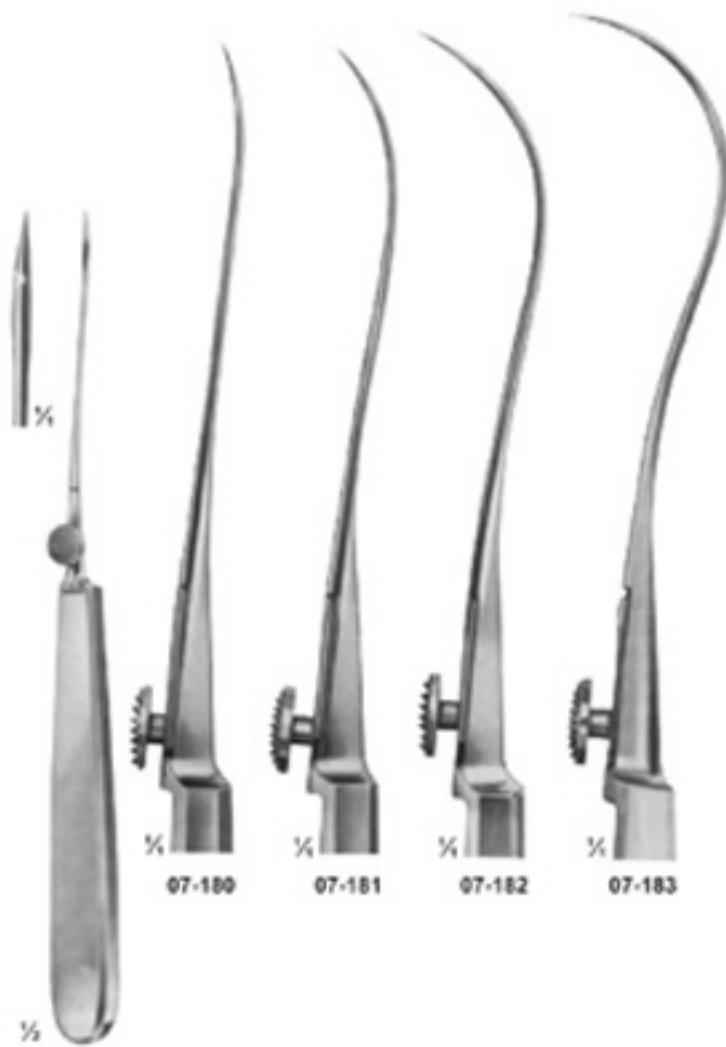

07-180

07-181

07-182

07-183

07-180 - 183
REVERDIN
195 mm



07-184

07-185

07-186

07-187

07-188

07-184 - 188
REVERDIN
220 mm

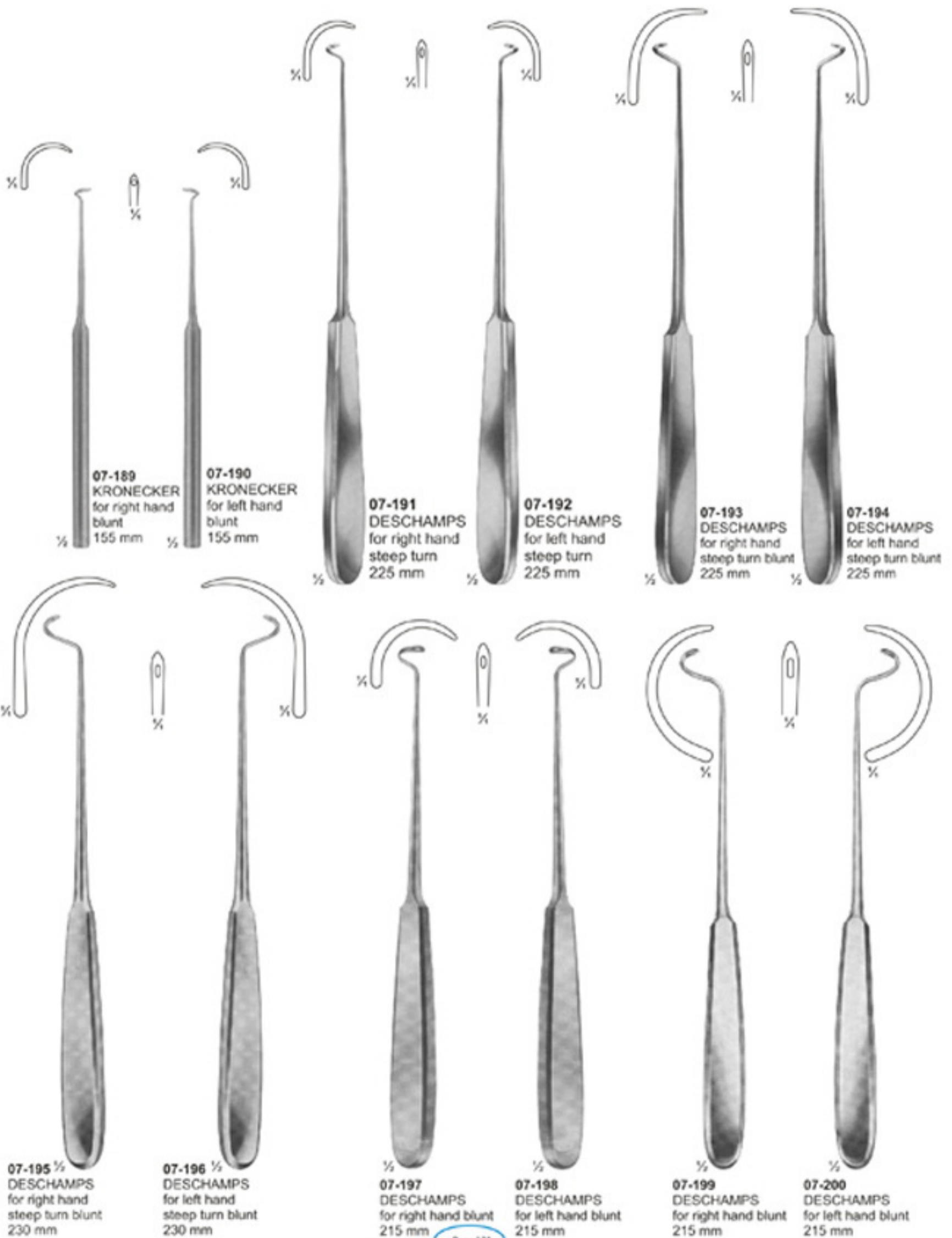



1/2
07-201
HURD
for right hand
sharp
210 mm



1/2
07-202
HURD
for left hand
sharp
210 mm

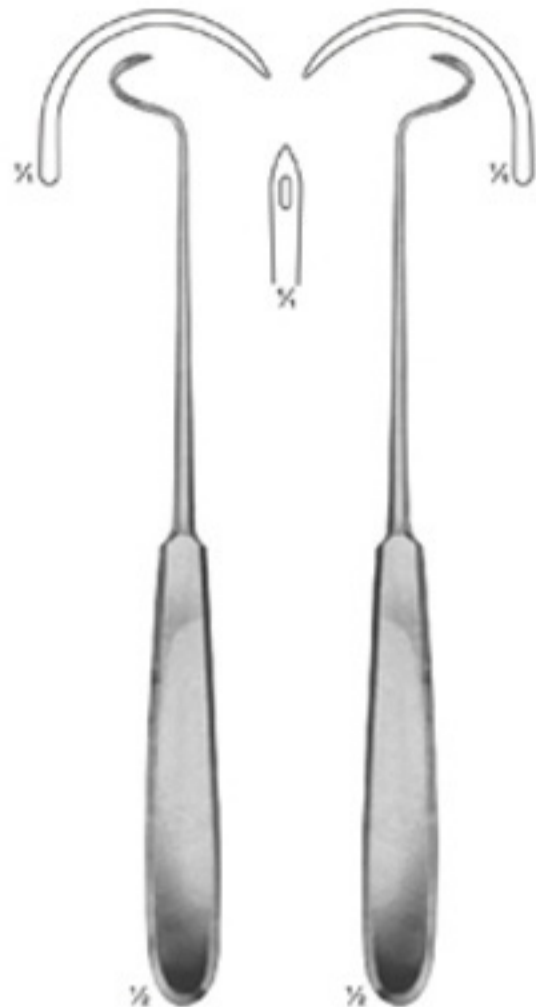

1/2
07-203
DESCHAMPS
for right hand
sharp
215 mm



1/2
07-204
DESCHAMPS
for left hand
sharp
215 mm



1/2
07-205
JONESCO
Needle for wire suture
185 mm



1/2
07-206
CLAUS VAN EICKEN
Needle for wire suture
250 mm



1/2
07-207
150 mm



1/2
07-208
SYME
170 mm



1/2
07-209
COOPER
205 mm

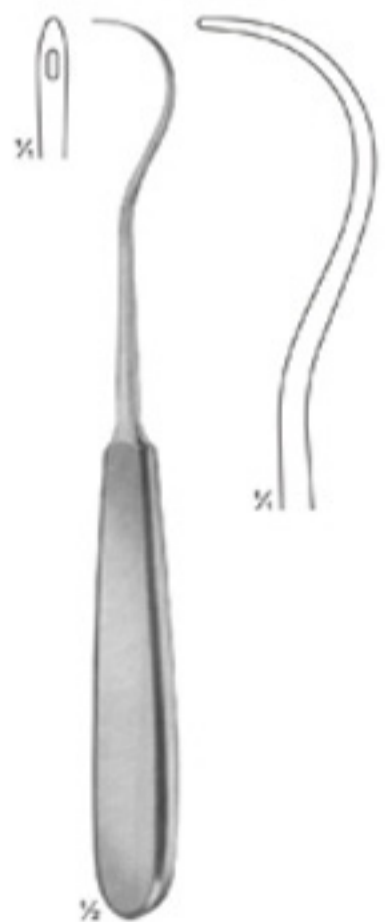

1/2
07-210
KOCHER
205 mm

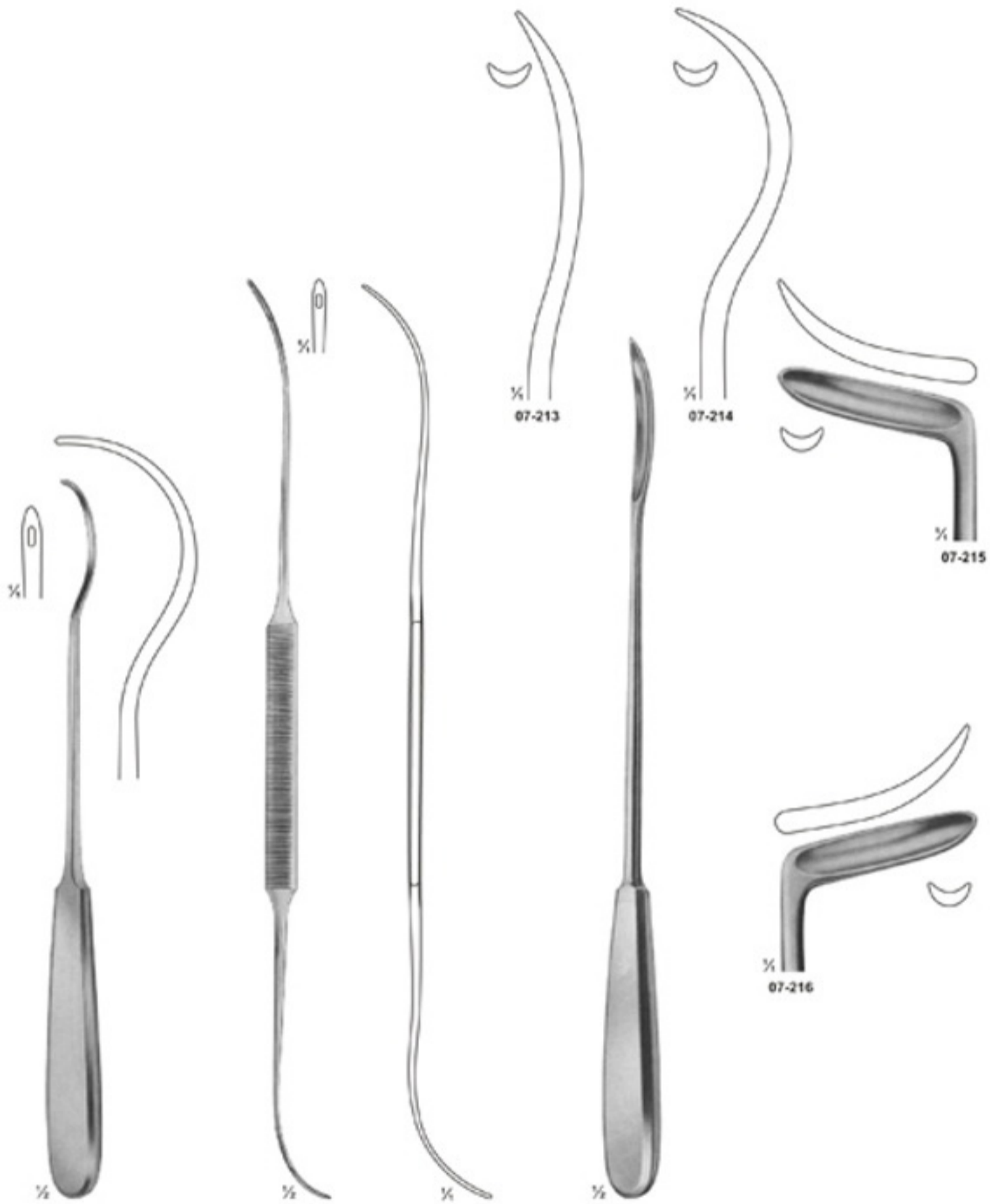

07-211
BRUNNER
240 mm

07-212
SCHMIEDEN-DICK
320 mm

07-213 - 216
BRUNNER
Guiding Probes
300 mm

07-242
2,5 mm
07-243
2,5 mm
07-244
3,0 mm



1/2

07-242 145 mm
07-243 160 mm
07-244 200 mm
Probes with eye

1,5 mm



1/2

07-245
Myrtle leaf probe
145 mm

2,0 mm



1/2

07-246 130 mm
07-247 145 mm
07-248 160 mm
07-249 180 mm
07-250 200 mm

1/2



07-251
Probes



1/2

07-252
Double ended probe,
malleable, diam. of tips
3 mm with hole
190 mm



07-253
Double ended probes,
tin, malleable,
diam. of tips
3,5 mm with hole
250 mm, 300 mm



1/4

07-254
Double ended probes,
tin, malleable,
diam. of tips 4 mm
400 mm

1/2



07-255 1,5 mm
07-256 2,0 mm
07-257 2,5 mm
300 mm



07-242
2,5 mm
07-243
2,5 mm
07-244
3,0 mm

07-242 145 mm
07-243 160 mm
07-244 200 mm
Probes with eye



1,5 mm

07-245
Myrtle leaf probe
145 mm



2,0 mm

07-246 130 mm
07-247 145 mm
07-248 160 mm
07-249 180 mm
07-250 200 mm



07-251
Probes



07-252
Double ended probe,
malleable, diam. of tips
3 mm with hole
190 mm



07-253
Double ended probes,
tin, malleable,
diam. of tips
3,5 mm with hole
250 mm, 300 mm



07-254
Double ended probes,
tin, malleable,
diam. of tips 4 mm
400 mm



07-255 1,5 mm
07-256 2,0 mm
07-257 2,5 mm
300 mm



07-258
STACKE
100 mm



07-259
KILLIAN
165 mm



07-260
160 mm



07-261
SEIFFERT
180 mm



07-262
BOWMAN
130 mm

German Silver



07-263
SPATULA
145 mm



07-264
SPATULA
145 mm



07-265
Modell PICCOLO
Round Serrated
110 mm



07-266
Modell PICCOLO
Triangular Serrated end
110 mm



07-267
FARRELL
Round Serrated end
110 mm



07-268
LATHBURY-FARREL
Triangular Serrated end
110 mm





07-269
BUCK
Rough, spiral end
120 mm



07-270
Triangular
serrated end
140 mm



07-271
Rough, spiral end
140 mm



07-272
Rough, spiral end
140 mm



07-273
Rough, spiral end
140 mm



07-274
FARRELL
Round,
serrated end
140 mm



07-275
LATHBURY-FARRELL
Triangular,
serrated end
140 mm



07-276
FARRELL
Rough,
spiral end
160 mm



07-277
LATHBURY-FARRELL
Triangular,
serrated end
160 mm



07-278
Triangular,
serrated end
160 mm



07-279
Rough,
spiral end
180 mm



07-280
Rough,
spiral end
180 mm



07-281
Rough,
spiral end
270 mm



07-282
MICHEL
125 mm



07-283
HEGENBARTH
120 mm



07-284
WACHENFELDT
120 mm



07-285
WACHENFELDT
120 mm



07-286
MICHEL
125 mm



07-287
MICHEL modif.
130 mm



07-288
HEATH
135 mm



07-289
COLLIN
135 mm

Cotton Applicators



07-290

Suturing instruments set, in metal case consisting of: Scissors, curved, sharp/sharp, 115mm
25 MICHEL clip, 16 x 3mm
1 Delicate tissue forceps, 130mm
1 Scalpel, bellied
1 MATHIEU needle holder, 140mm
1 Perforated metal case, stainless containing:
1 Suture needle
1 item 1 item



07-291

Pocket instrument set, in metal case consisting of:

Bottom tray

1 MATHIEU needle holder, 140mm
1 MICHEL clip forceps, combined
1 Myrtle leaf probe, 130mm
1 Sharp double curette
1 Skin hook
1 Detachable scalpel handle, no.4
1 Perforated metal case, containing
6 Scalpel blades BB 520
1 Perforated metal case, stainless, containing
1 Suture needle
1 item
1 item

Top tray

1 Tissue forceps, 130mm
1 KOCHER haemostatic forceps, 130mm
1 Straight surgical scissors, 130mm
1 Dissecting forceps, 130mm
1 FEILCHENFELD splinter forceps, 115mm
25 MICHEL clip, 16 x 3mm
1 Flacon of suture skin, sterile in alcohol



07-292

Pocket instrument set, in metal case consisting of:

Bottom tray

1 MAYO-HEGER needle holder, 150mm
1 MICHEL clip forceps, combined
1 Myrtle leaf probe, 130mm
1 Sharp double curette
1 Skin hook
1 Detachable scalpel handle, no. 4
1 Perforated metal case, consisting
6 Scalpel blades BB 520
1 Perforated metal case, stainless, consisting:
1 Suture needle
1 item, & 1 item

Bottom tray

1 Tissue forceps, 130mm
1 CRILE haemostatic forceps, 140mm
1 Straight surgical scissors, 130mm
1 Dissecting forceps, 130mm
1 FEILCHENFELD splinter forceps, 115mm
25 MICHEL clip, 16 x 3mm
1 Flacon of suture silk, sterile in alcohol



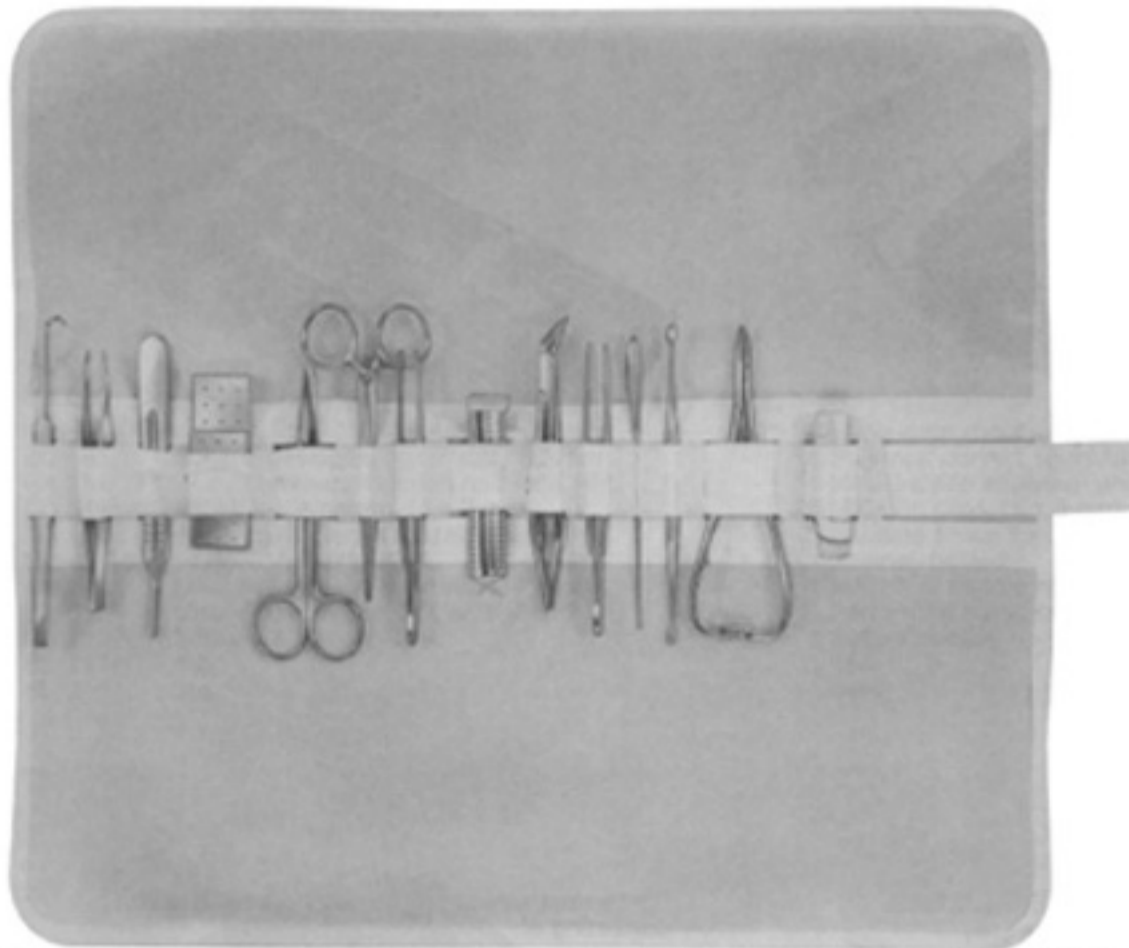

07-293

Pocket instrument set in metal case 170 x 90mm with sterilizable canvas roll consisting of:

- 1 Myrtle leaf probe, 130mm
- 1 Sharp double curette
- 1 FEILCHENFELD splinter forceps, 115mm
- 1 Dissecting forceps, 130mm
- 1 Tissue forceps, 130mm

- 1 Straight surgical scissors, 130mm
- 1 Scalpel handle no. 4
- 1 Perforated metal case, consisting 6 scalpel blades BB 520
- 1 KOCHER haemostatic forceps, 130mm
- 1 Skin hook
- 1 MATHIEU needle holder, 140mm
- 1 Tube of suture skin, sterile in alcohol
- 1 MICHEL clip forceps, 120mm

25 MICHEL clip, 16 x 3mm
1 Perforated metal case, stainless, consisting:
 1 Suture needle
 1 item
 1 item

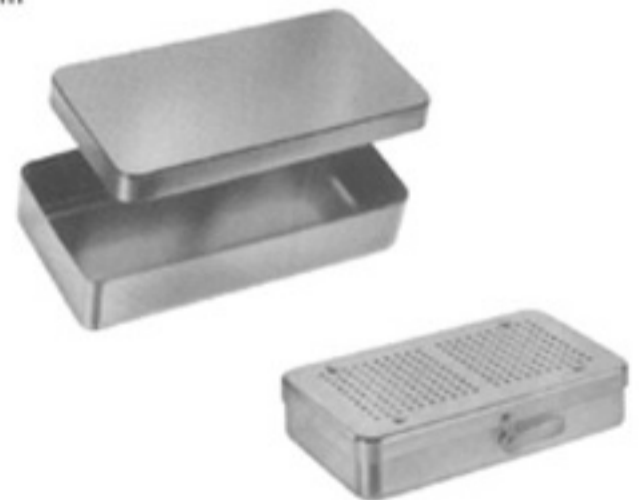

07-294

Venae sectio set, in sterilizable canvas roll consisting of:

- 1 Tissue forceps, 1 x 2 teeth, 140mm
- 1 Dissecting forceps, 145mm
- 1 FEILCHENFELD straight scissors, sharp, 110mm
- 1 curved scissors, blunt, 115mm
- 1 HALSTED mosquito forceps, curved on flat, 125mm

- 1 DESCHAMPS needle, blunt, 210mm
- 1 DOYEN Director, curved, 140mm
- 2 Wound retractors, 4 blunt prongs, 160mm
- 2 DESMARRES wound retractors, 135mm
- 1 FINSSEN retractors, 2 x3 blunt prongs, 80mm

1 Scalpel handle no. 4
 4 Sterile scalpel blades, no 18, single peel pack
 1 Needle box, perforated, round, diam. 65mm
 1 HEGAR-MAYO DUROGRIP needle holder, 180mm



07-295

Venae sectio set, in metal case
consisting of:

Bottom tray

- 1 MATHIEU needle holder, fine pattern 140mm
- 1 Ligature needle, fine short pattern
- 1 DOYEN director, curved
- 1 HEGENBARTH clip forceps,
- 1 ELSCHNIG tissue forceps, 1 x 2 teeth fine, 150mm
- 1 Dressing forceps, fine 105mm
- 1 Tissue forceps, 1 x 2 teeth, 110mm
- 1 Vessel scissors, straight, with 1 ball point, 110mm
- 1 Vessel scissors, curved, pointed 105mm
- 1 FINSSEN retractor
- 1 Perforated needle case

Top tray

- 1 Scalpel, pointed
- 1 Scalpel, bellied
- 2 HALSTED mosquito forceps, curved, 125mm
- 2 HALSTED mosquito forceps, straight, 1x 2 teeth, 125mm
- 3 BACKHAUS towel forceps, 90mm
- 2 Flacon holder

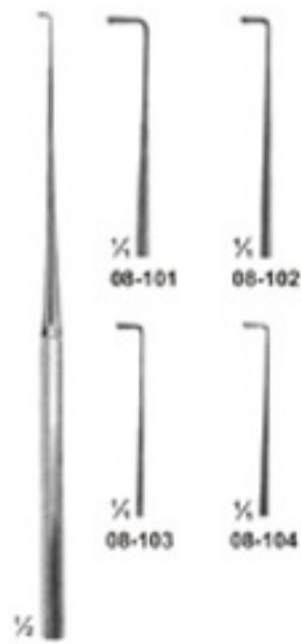

08-101 - 104
WAGENER
150 mm

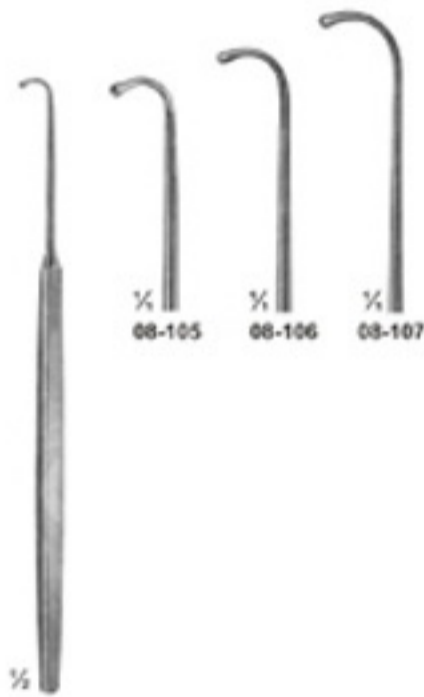

08-105 - 107
GRAEFE
140 mm



08-108
BROM
Vein hook
170 mm



08-109
CRILE
200 mm



08-110 - 111
CUSHING
190 mm

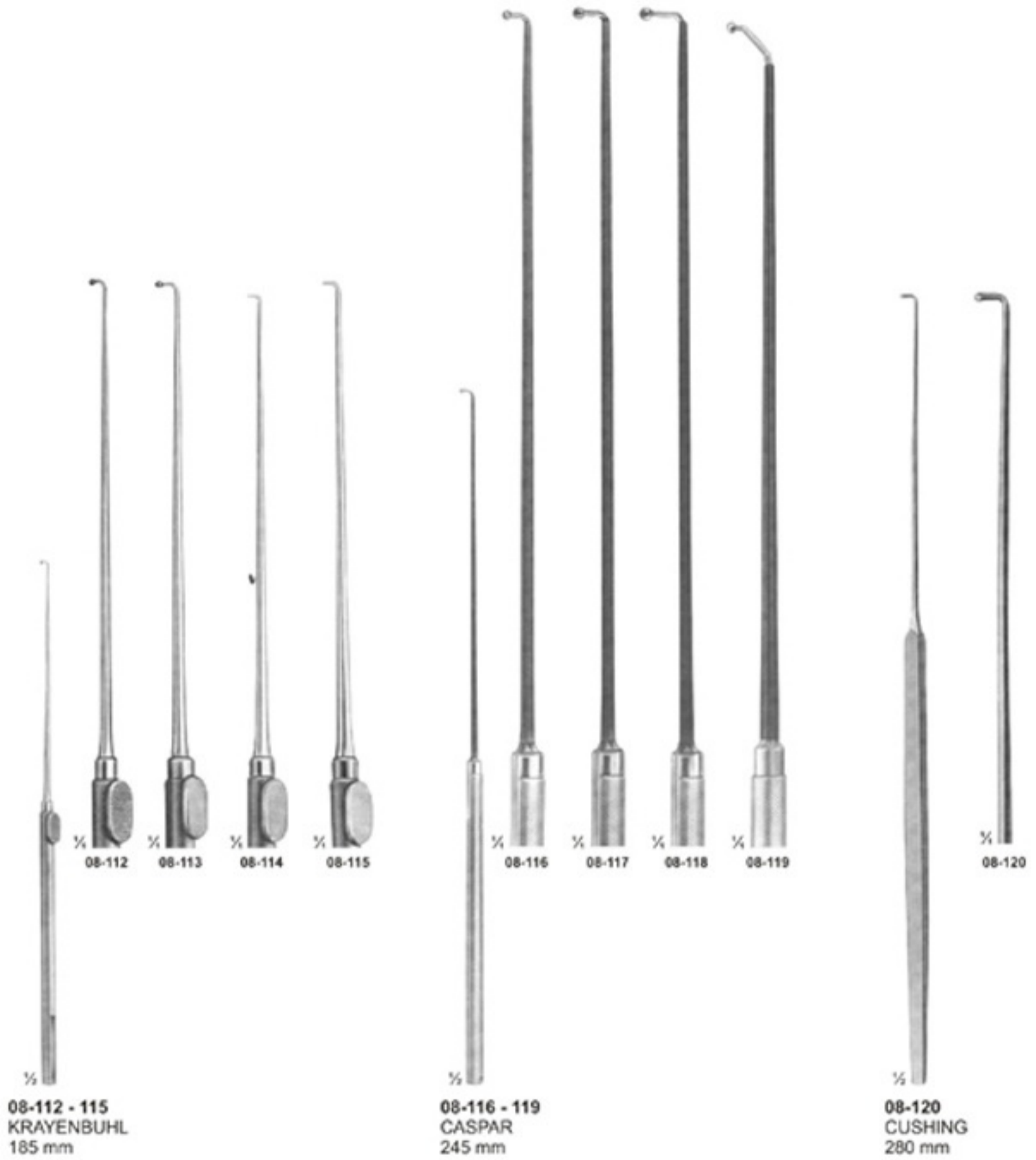

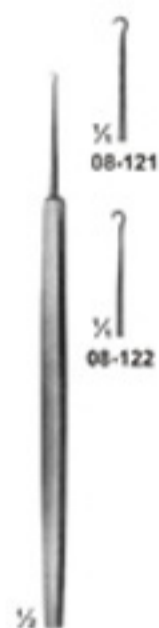

08-121 Sharp
08-122 Blunt
GRAEFE
125 mm

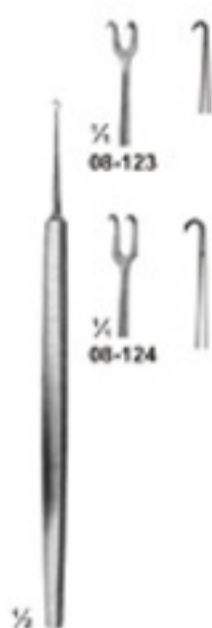

08-123 125 mm
08-124 130 mm
Sharp
GUTHRIE

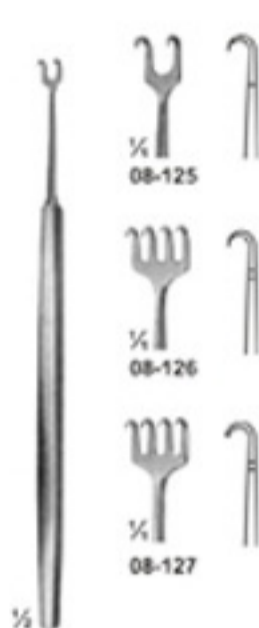

08-125 130 mm
08-126 135 mm
Sharp
ROLLET
08-127 135 mm
Blunt



08-128
FRAZIER
Dura Retractors
130 mm



08-129
TONNIS
Dura Retractors
150 mm



08-130
KILNER
160 mm



08-131
FREER
150 mm



08-132
MULLER
150 mm

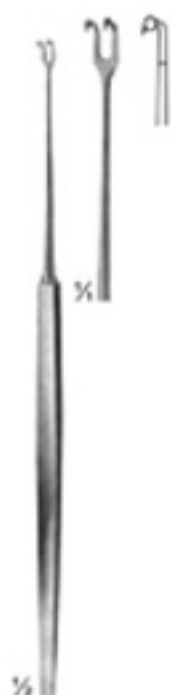

08-133
MULLER
150 mm



08-134
COTTLE
160 mm

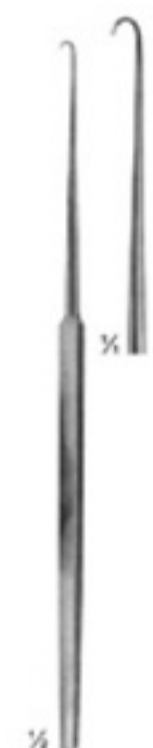

08-135
COTTLE
160 mm



08-136
JAEGAR
135 mm



08-137 - 140
JOSEPH
165 mm



08-137
08-138
3 mm
08-139
6 mm
08-140
8 mm



08-141
08-142
08-141 - 142
GILLIES
180 mm



7 X 12 mm
3 X 11 mm
8 X 12 mm
08-143
KILNER
Sharp
80 mm
08-144
CONVERSE
Blunt
120 mm

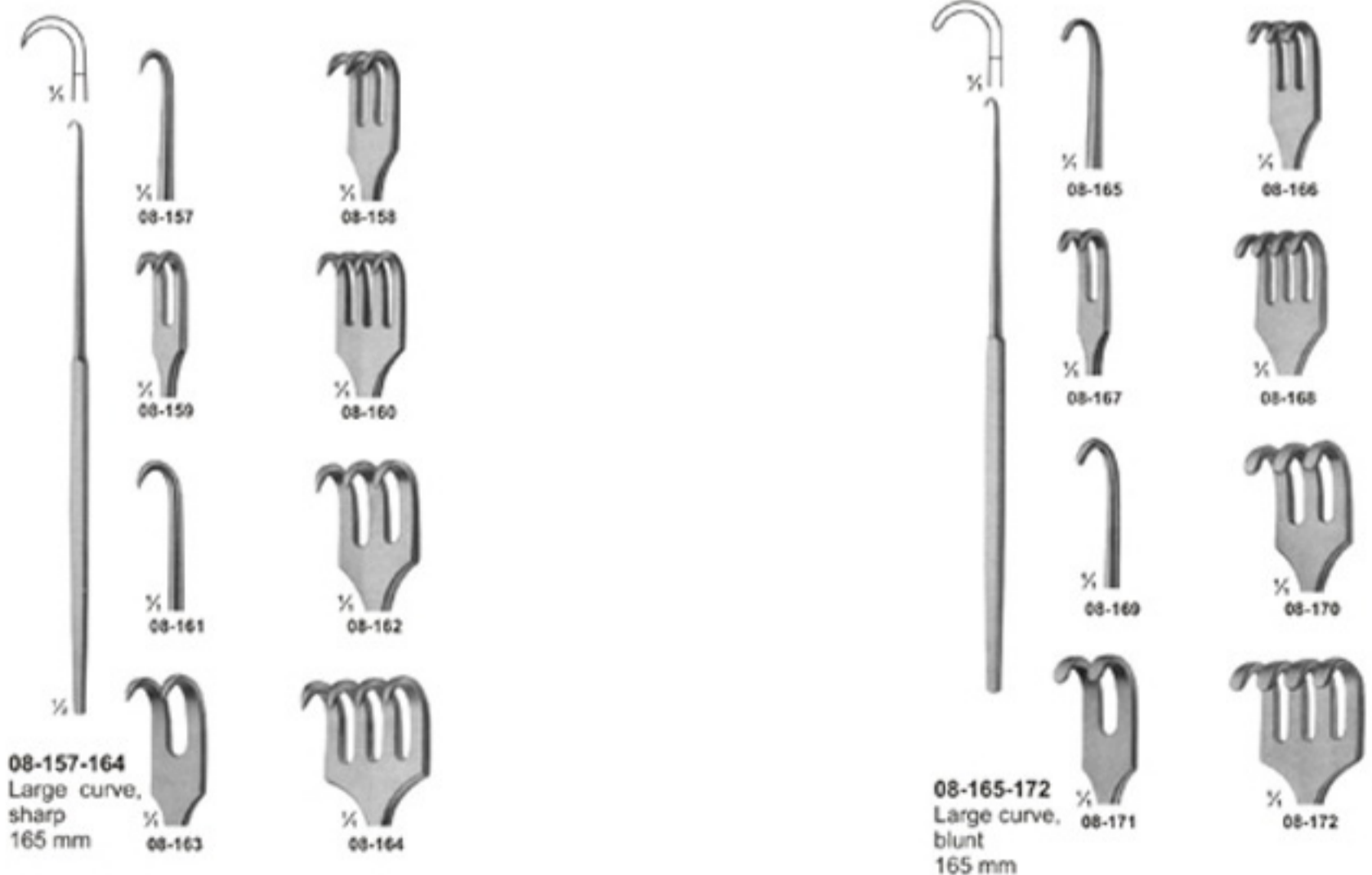

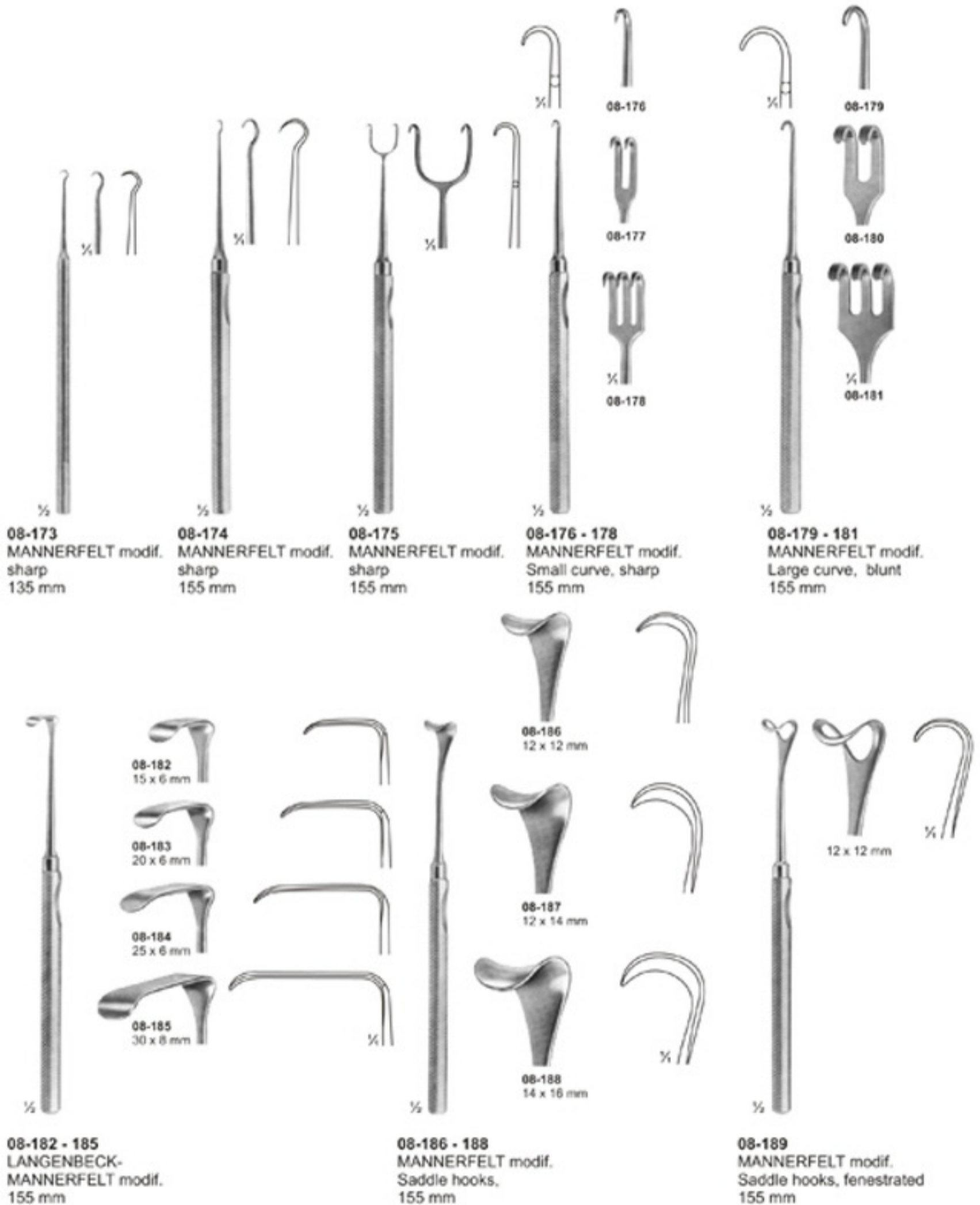



08-190
FOMON
145 mm



08-191 - 192
160 mm



08-193 - 194
LANGENBECK-GREEN
160 mm

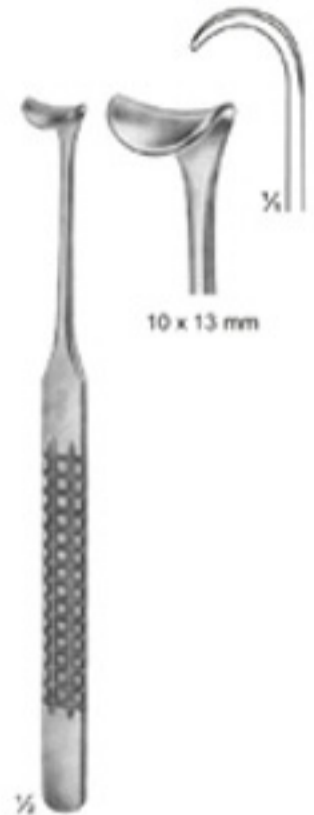

08-195
160 mm



08-196 - 201
MEYERDING
Fig. A - Fig. F
180 mm



08-196
18 x 7 mm



08-197
16 x 5 mm



08-198
7 x 4 mm



08-199
5 x 10 mm



08-200
11 x 4 mm



08-201
6 x 4 mm

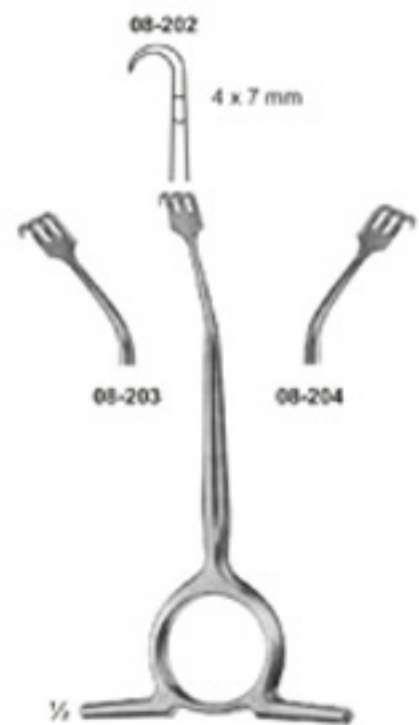

08-202
4 x 7 mm

08-203

08-204

08-202 - 204
WILLIGER
120 mm



08-205
EMMET
Fistula hook
220 mm



08-206
SIMON
Fistula hook
220 mm



08-207
SIMON
Fistula hook
220 mm



08-208
LANGE
Fistula hook
230 mm



12 x 6 mm

08-209



12 x 11 mm

08-210

08-209 - 210
Tendon hooks
175 mm



15 x 11 mm

08-211

08-211
KLAPP
Tendon hooks
175 mm



1/4
6 x 12 mm

1/4
08-212
MASING
140 mm



1/4
10 x 12 mm

1/4
08-213
COTTLE
140 mm



08-214
9 x 9 mm



08-215
9 x 12 mm

1/4
08-214 - 218
DESMARRES
140 mm



1/4
08-216
11 x 14 mm



08-217
12 x 16 mm



1/4
08-218
13 x 18 mm



1/4
08-219
13 x 13 mm



1/4
08-220
12 x 16 mm

1/4
08-219 - 220
KONIG
180 mm



1/4
10 x 10 mm

1/4
08-221
CUSHING-KOCHER
175 mm



1/4
08-222 - 223
KOCHER
205 mm



1/4
08-222
20 x 12 mm



1/4
08-223
20 x 15 mm



1/4
08-224
SCHOENBORN
200 mm



1/4
13 x 6 mm



1/4
08-225 - 226
CUSHING
205 mm



1/4
08-225
10 x 13 mm



1/4
08-226
14 x 18 mm



1/4
08-227
205 mm

20 x 15 mm

20 x 19 mm



1/4
08-228 - 230
CUSHING
250 mm



1/4
08-228
11 x 14 mm



1/4
08-229
13 x 18 mm



1/4
08-230
15 x 22 mm

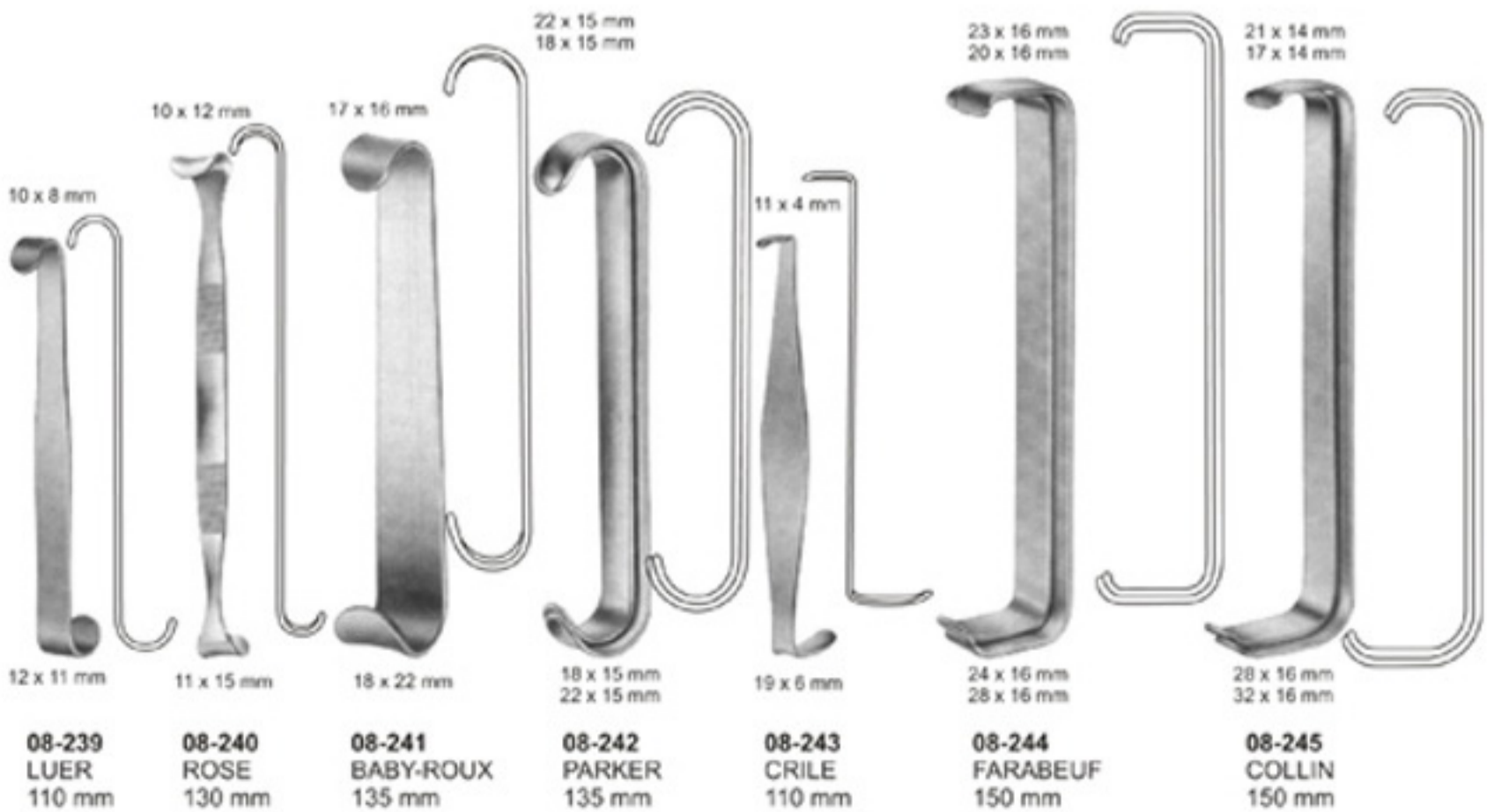

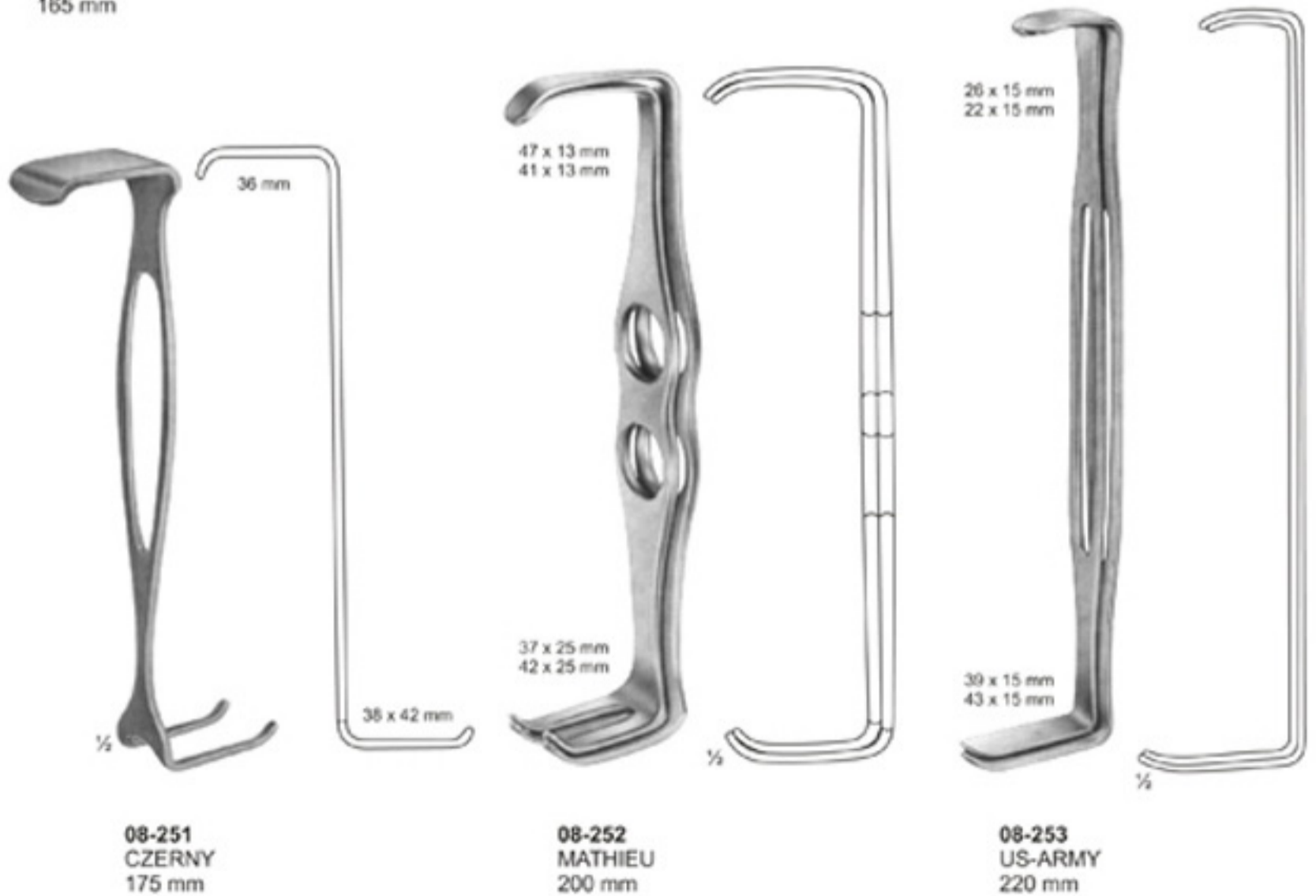
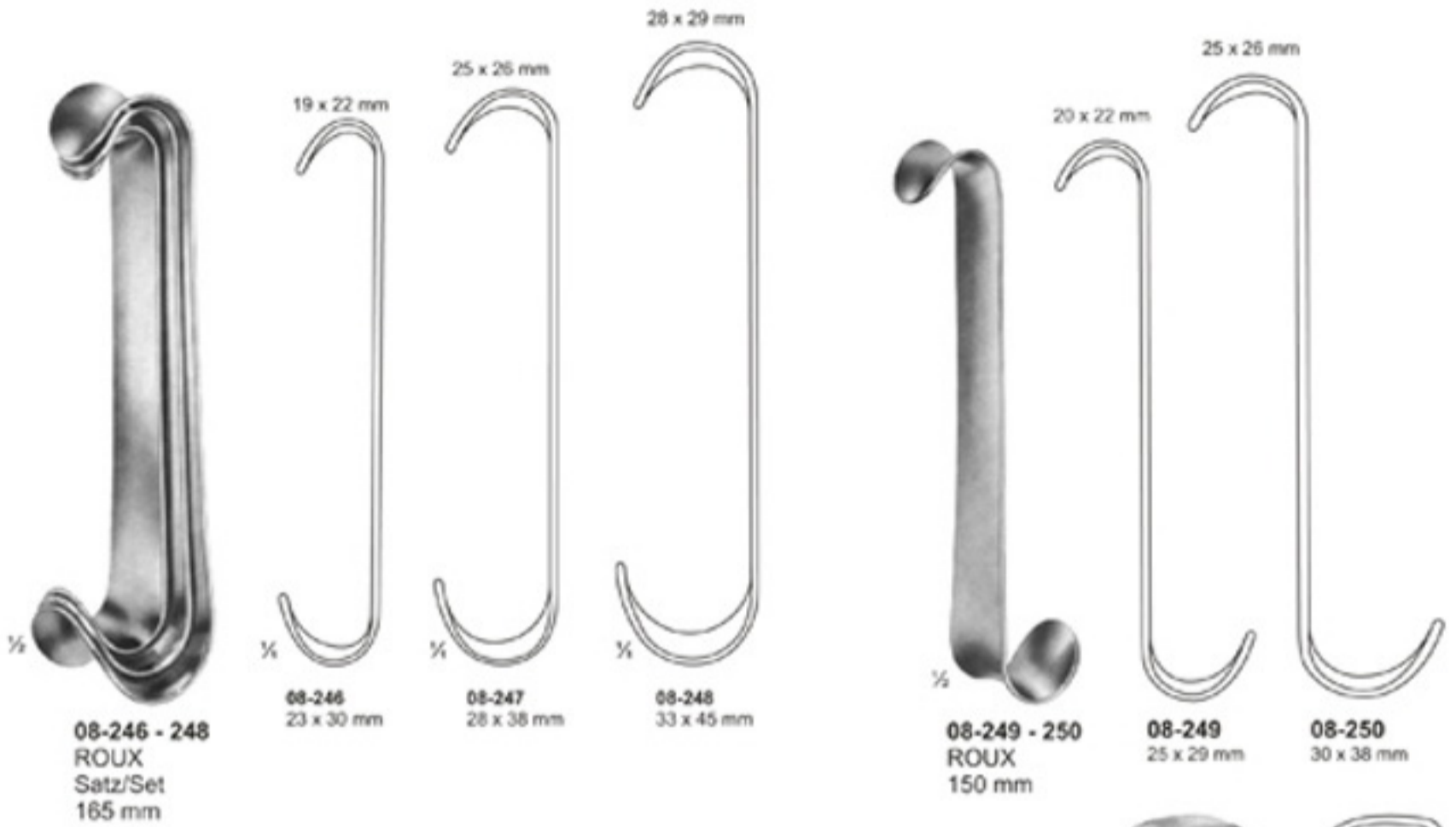



08-254
KOCHER
Sharp
205 mm



08-255
KOCHER
Sharp
220 mm



08-256
KOCHER
Blunt
220 mm



08-257
VOLKMANN
Sharp
220 mm



08-258
VOLKMANN
Sharp
220 mm



08-259 - 266
VOLKMANN
225 mm



Sharp

1/2



Blunt

1/2



08-259
9 x 8 mm



08-260
9 x 13 mm



08-261
9 x 19 mm



08-262
9 x 29 mm



08-263
8,5 x 8 mm



08-264
8,5 x 13 mm



08-265
8,5 x 19 mm



08-266
8,5 x 29 mm

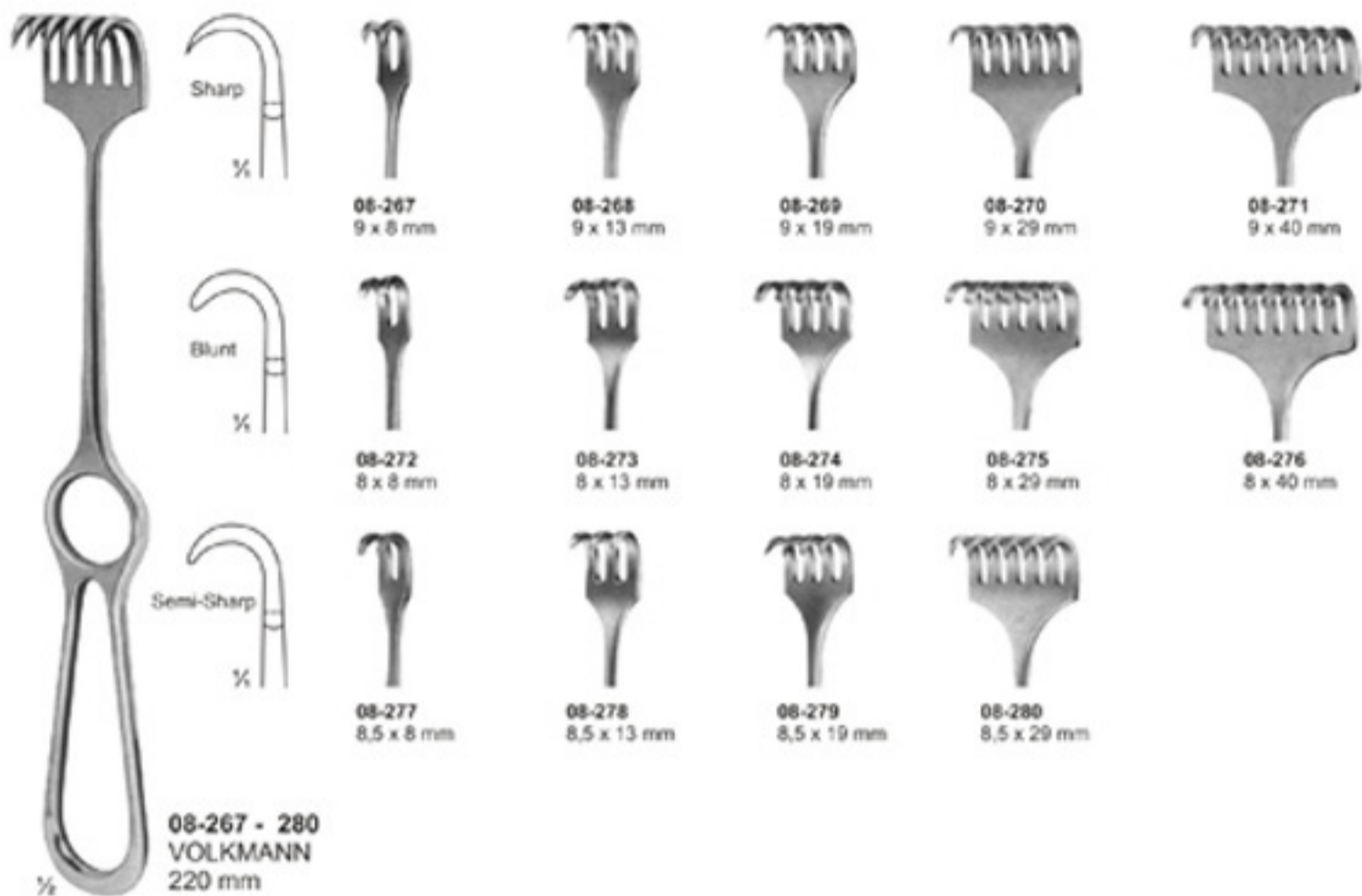



08-289 - 290
KORTE
240 mm



08-289
8 Prongs, blunt



08-290
8 Prongs, sharp



08-291 - 294
ISRAEL
255 mm

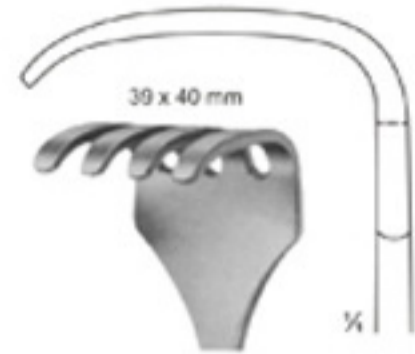

08-291
4 Prongs, blunt

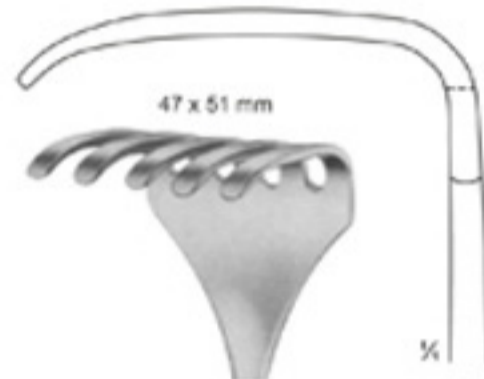

08-292
5 Prongs, blunt

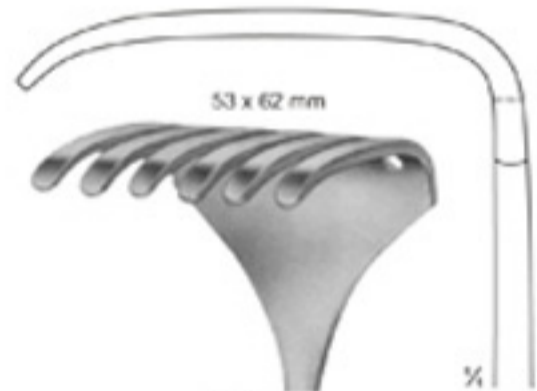

08-293
6 Prongs, blunt

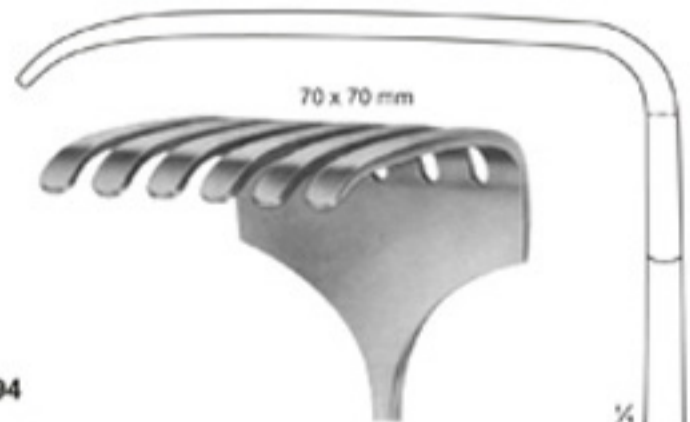

08-294
6 Prongs, blunt



08-295 - 300
LANGENBECK
210 mm

08-295	28 x 10 mm
08-296	28 x 14 mm
08-297	33 x 14 mm
08-298	28 x 16 mm
08-299	40 x 10 mm
08-300	40 x 13 mm



08-301 - 307
KOCHER-LANGENBECK
215 mm

08-301	25 x 6 mm
08-302	35 x 8 mm
08-303	35 x 11 mm
08-304	35 x 15 mm
08-305	41 x 11 mm
08-306	55 x 11 mm
08-307	70 x 14 mm



08-308
LANGENBECK
215 mm



08-309 - 313
KOCHER
230 mm

1/2



08-314 - 316
SAUERBRUCH
225 mm

1/2

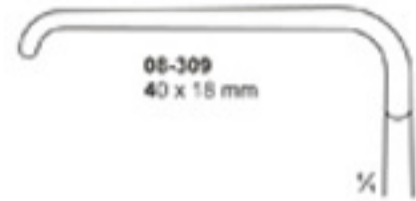

08-309
40 x 18 mm

1/2

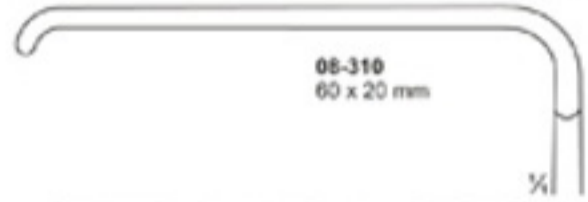

08-310
60 x 20 mm

1/2



08-311
60 x 25 mm

1/2



08-312
75 x 30 mm

1/2



08-313
75 x 40 mm

1/2



08-314
46 x 16 mm

1/2



08-315
55 x 22 mm

1/2

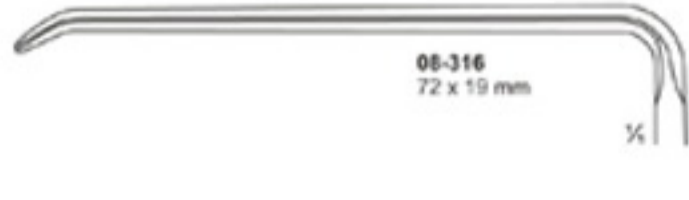

08-316
72 x 19 mm

1/2

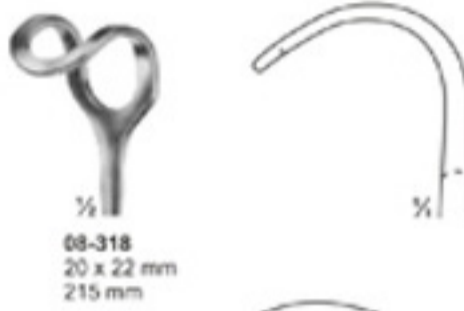

08-320
BUCHS
205 mm



08-321
CASPAR
210 mm

08-322
KOCHER
230 mm



1/2
08-323 - 328
HOSEL
250 mm



08-323
60 x 20 mm

1/4



08-324
80 x 30 mm

1/4



08-325
100 x 30 mm

1/4



08-326
120 x 30 mm

1/4



08-327
140 x 30 mm

1/4



08-328
140 x 40 mm

1/4



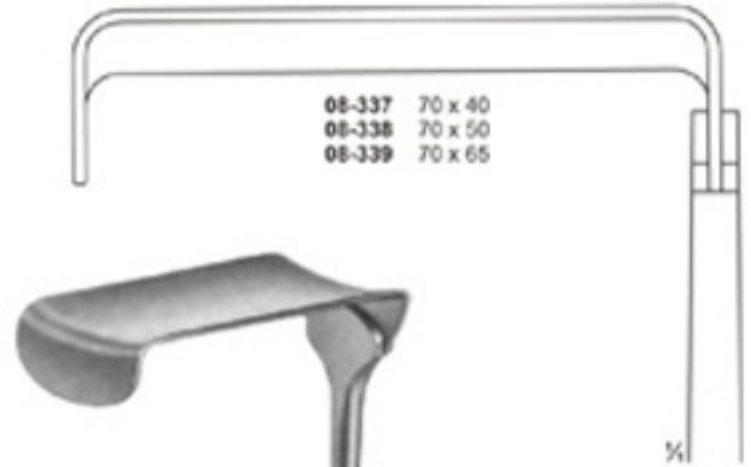
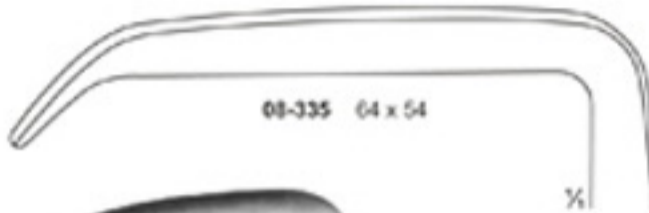
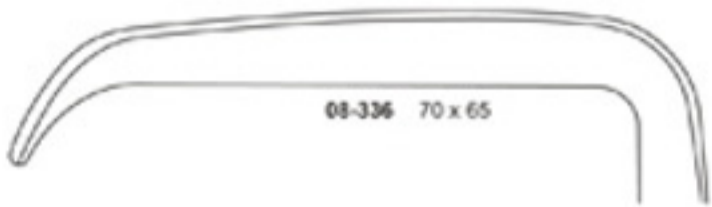

08-335 - 336
KELLY
260 mm



08-337 - 339
MORRIS
245 mm





08-347 - 353
BRUNNER
275 mm

08-347	80 x 20
08-348	100 x 25
08-349	120 x 25
08-350	130 x 30
08-351	140 x 30
08-352	160 x 30
08-353	180 x 30

1/4



08-354
Handle with cold
light carrier for
retractor blades.
280 mm

1/4



Handle arrange-
ment variable

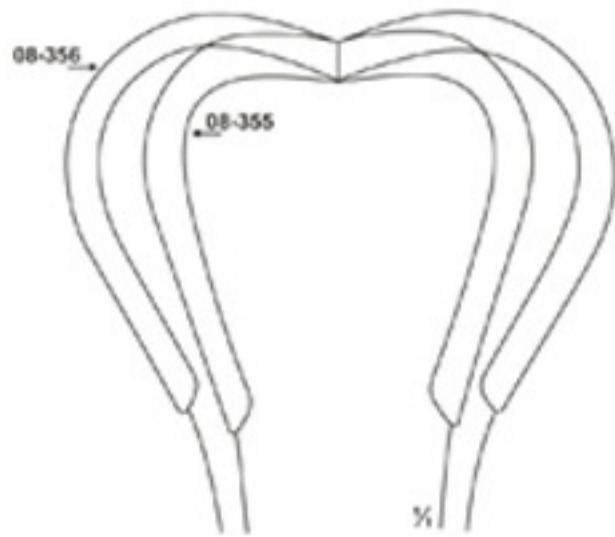

08-355 - 356
HARRINGTON
08-355 123 x 45 mm
08-356 123 x 64 mm
Flexible
295 mm



08-357
ALLISON
255 mm



08-358
ALLISON
320 mm



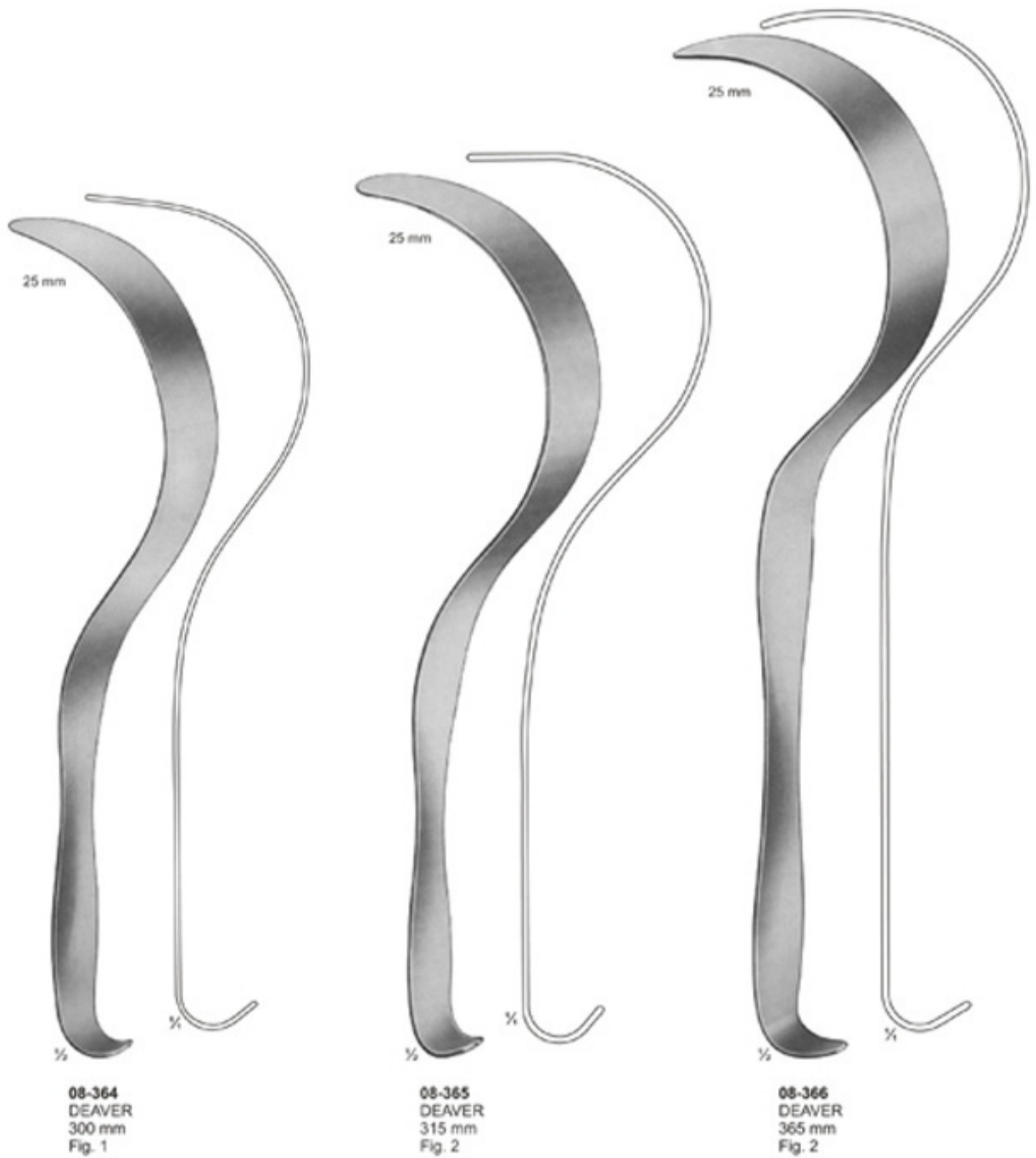



08-367
DEAVER
300 mm
Fig. 3

08-368
DEAVER
310 mm
Fig. 4

08-369
DEAVER
320 mm
Fig. 5



08-370
DEAVER
310 mm
Fig. 1



08-371
DEAVER
310 mm
Fig. 3



08-372
DEAVER
305 mm
Fig. 3



08-373
DEAVER
310 mm
Fig. 4

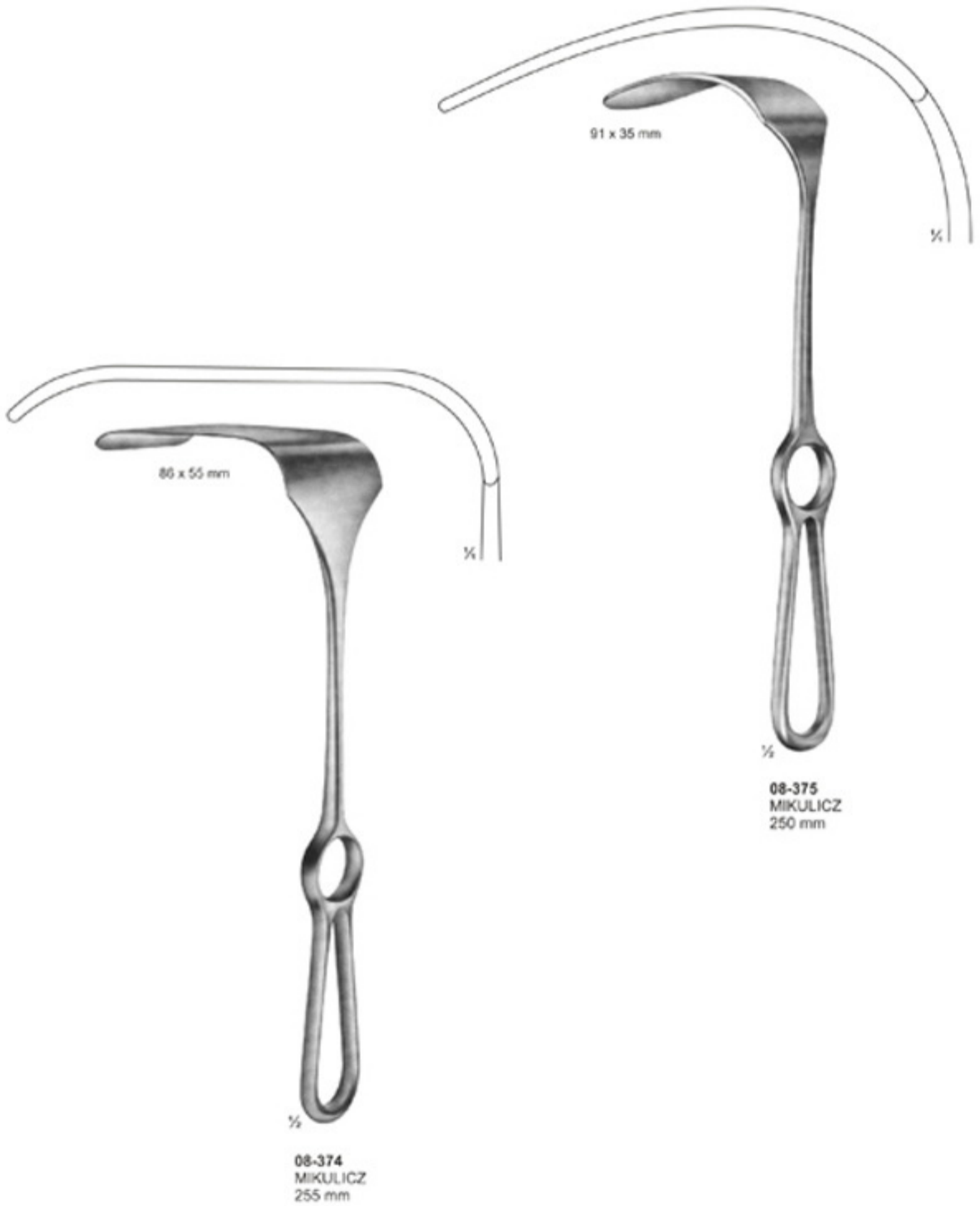

08-378 150 x 39 mm
08-379 150 x 57 mm

08-376 121 x 50 mm
08-377 147 x 50 mm

08-378 - 379
KELLY
08-378 150 x 39 mm
08-379 150 x 57 mm
260 mm

08-376 - 377
MIKULICZ
08-376 121 x 50 mm
08-377 147 x 50 mm
Liver Retractor
250 mm



	Width of Blades
	35 mm, 45 mm, 60 mm
Length of Blades	
62 mm	08-380, 08-381, 08-382
92 mm	08-383, 08-384, 08-385
122 mm	08-386, 08-387, 08-388
160 mm	08-389, 08-390

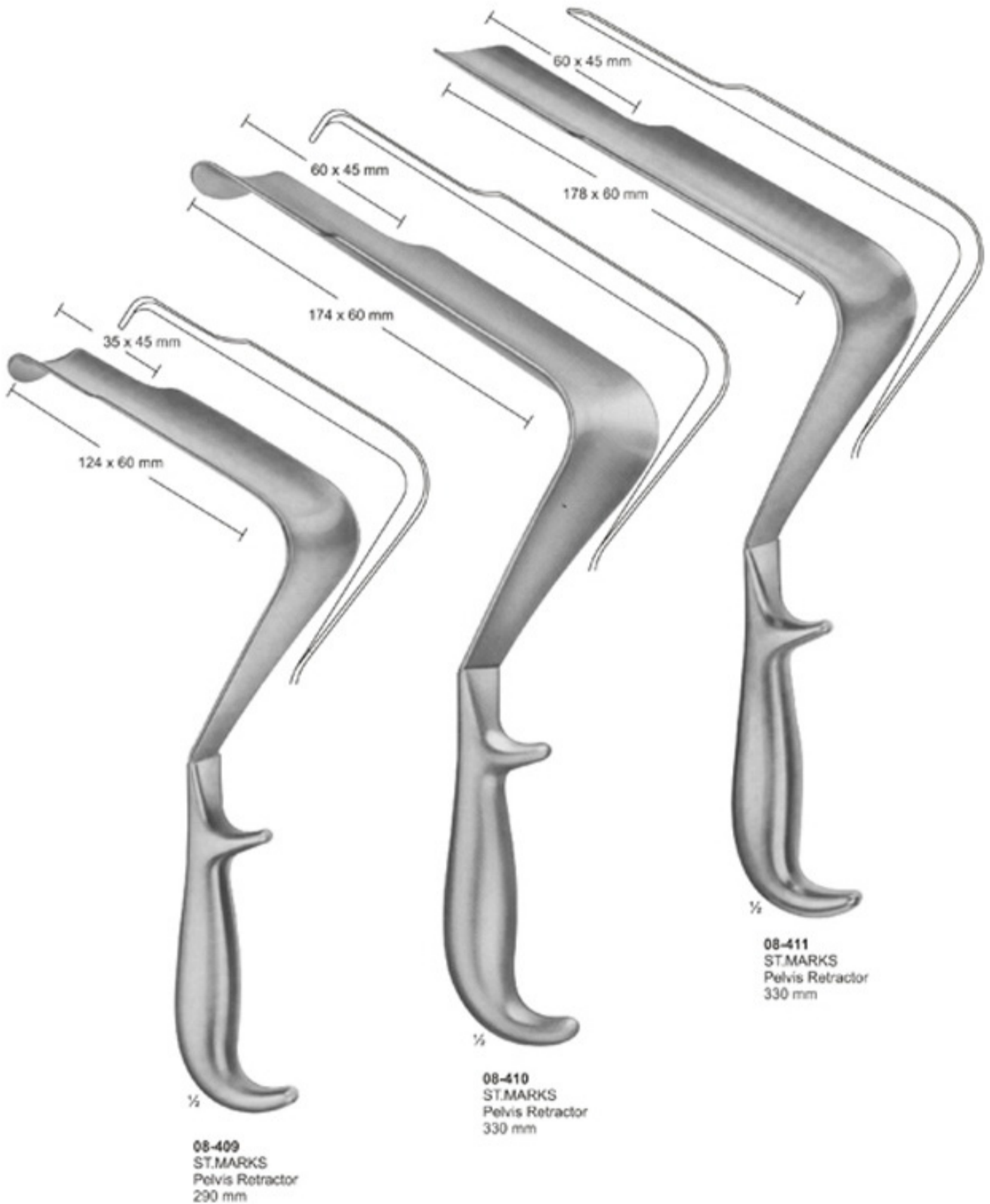



08-412
LERICHE
255 mm

08-413
KUMMEL
Malleable
285 mm

08-414
MIKULICZ
29 mm
250 mm

08-415 - 416
KADER
08-415 30 mm
08-416 40 mm
270 mm



08-417
REVERDIN
285 mm



08-418
HABERER
Malleable
305 mm



08-419 30 mm
08-420 40 mm
08-421 50 mm
Malleable
330 mm



08-422
TUFFIER
Malleable
200 mm



08-423
BOSE
60 mm



08-424
FINSEN
50 mm



08-425
FINSEN
70 mm



08-426
FINSEN modif.
75 mm



08-427
45 mm

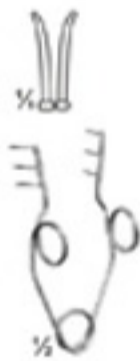

08-428
55 mm



08-429
MUELLER
65 mm



08-430
100 mm



08-431 - 432
ALM
08-431 70 mm
08-432 100 mm



08-433
LOGAN
modif. REILL
50 mm



08-434
JANSEN
100 mm



08-435
JANSEN
100 mm



08-436
BARRAQUER
45 mm



08-437
WEITLANER
Sharp
110 mm



08-438
WEITLANER
Semi-Sharp
110 mm



08-439
WEITLANER
Blunt
110 mm



08-440
WEITLANER
Sharp
130 mm



08-441
WEITLANER
Semi-Sharp
130 mm



08-442
WEITLANER
Blunt
130 mm

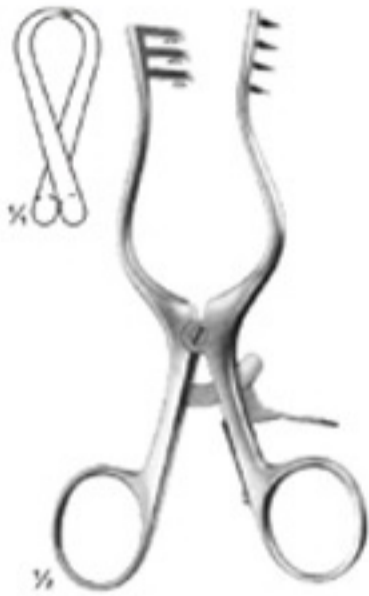

08-443
WEITLANER
Sharp
130 mm

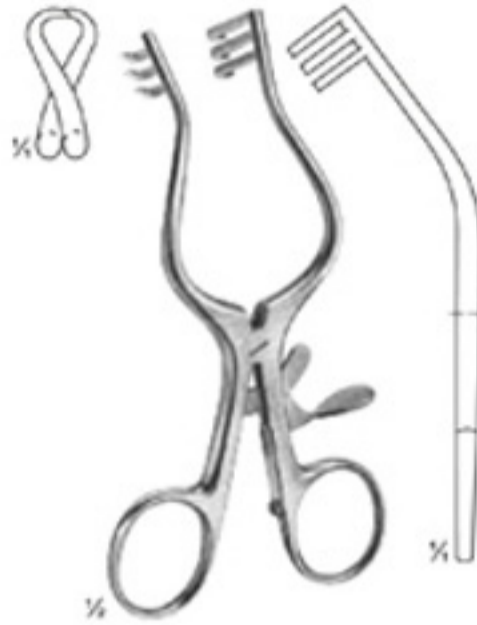

08-444
WULLSTEIN
Sharp
130 mm

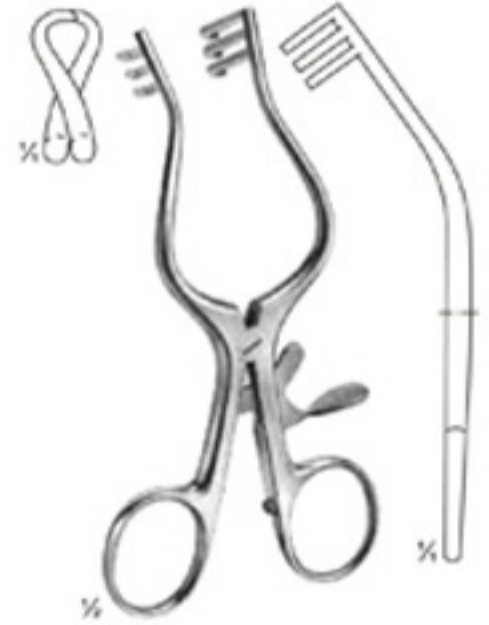

08-445
WULLSTEIN
Blunt
130 mm



08-446
WEITLANER
Sharp
165 mm



08-447
PLESTER
Blunt
110 mm

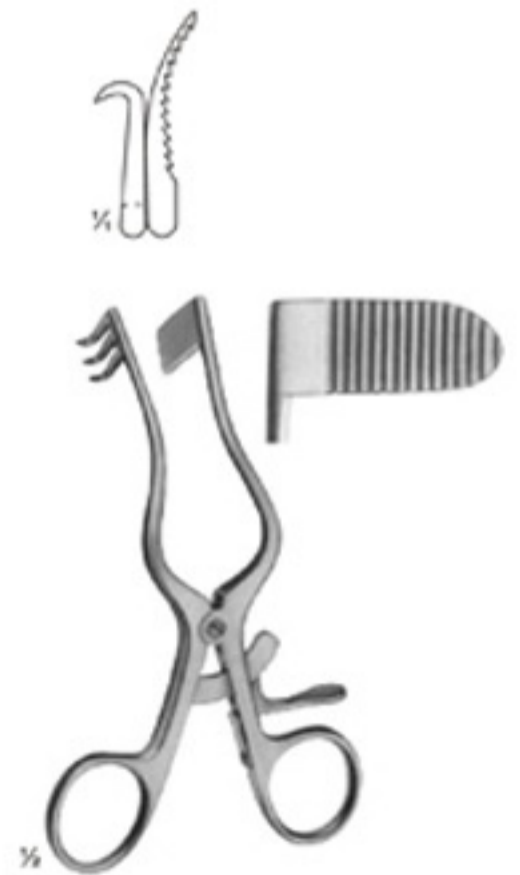

08-448
PERKINS
130 mm



08-449
ADSON-BABY
Blunt
140 mm



08-450
MOLLISON
Sharp
155 mm



08-451
MAYO-ADAMS
165 mm



08-452
ANDERSON-ADSON
Sharp
190 mm

08-453
NORFOLK and
NORWICH
Blunt
220 mm

08-454
ADSON
Sharp
265 mm

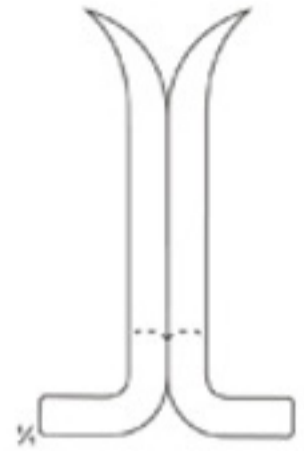

08-455 - 456
BECKMANN-ADSON
Sharp
310 mm



08-456
BECKMANN-ADSON
Semi-Sharp
310 mm



08-457
ADSON
Semi-Sharp
320 mm



08-458
BECKMANN-EATON
Sharp
320 mm



1/2

08-459
JOLL (FRIEDMAN)
Thyroid- and Vaginal Retractor
155 mm



1/2

08-460
JACKSON BURROWS
Retractor, blunt
185 mm



1/2



1/2

08-461
GELPI
Vaginal Retractor
135 mm



1/2



1/2

08-462
GELPI
Skin- and Vaginal Retractor
175 mm



1/2



1/2

08-463
DE BAKEY
Femur Retractor
145 mm



08-464 - 468
SCOVILLE-RICHTER
 Retractor with 1 pair
 blades reversible type.
 The Retractor bar and
 shanks may be easily
 rotated 180° when
 blades are in situ.



08-465
 62 x 52 mm 62 x 37 mm
 PR= Pair



08-466
 47 x 51 mm



08-467
 30 x 40 mm



08-468
 37 x 62 mm



08-469
CLOWARD modif.
Spreader Only



08-470



08-471



08-475



08-476

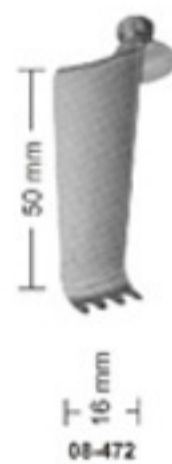

08-472



08-473



08-477



08-478

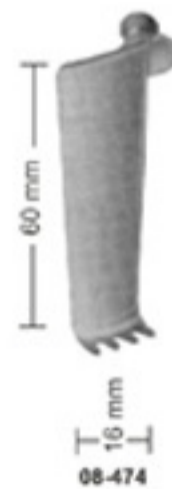

08-474



08-479

08-470 blade
08-471 blade
08-472 blade
08-473 blade
08-474 blade

08-475 blade
08-476 blade
08-477 blade
08-478 blade
08-479 blade

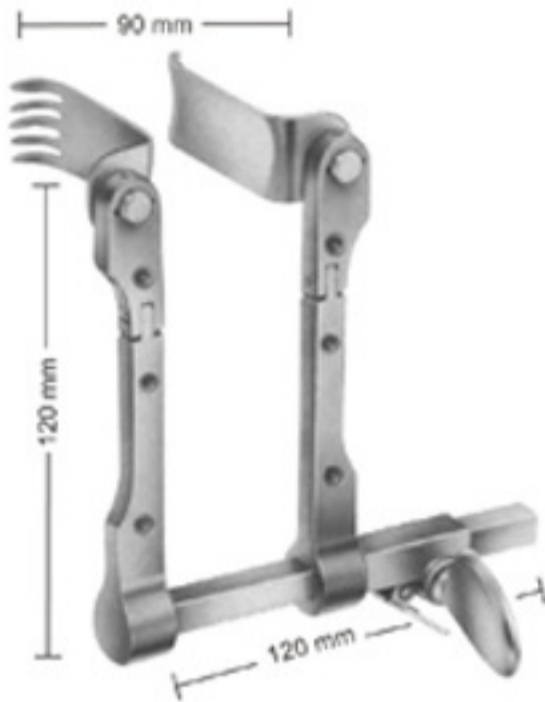

08-480
CASPAR
Retractor, adjustable,
consisting of: 5 medial
blades, 5 Lateral blades.



08-480 A
CASPAR
Counter retractor, adjustable,
consisting of: 5 blades.



08-481 40 x 23 mm
08-482 45 x 23 mm
08-483 50 x 23 mm
08-484 55 x 23 mm
08-485 60 x 23 mm
Medial blades

08-486 40 x 23 mm
08-487 45 x 23 mm
08-488 50 x 23 mm
08-489 55 x 23 mm
08-490 60 x 23 mm
Lateral blades

08-491 45 x 23 mm
08-492 50 x 23 mm
08-493 55 x 23 mm
08-494 60 x 23 mm
08-495 65 x 23 mm
Blunt blades

08-496 50 x 25 mm
08-497 60 x 25 mm
Blunt blades,
for harvesting of the
fusion graft from the
ilac crest

08-498 40 x 25 mm
08-499 45 x 25 mm
08-500 50 x 25 mm
08-501 55 x 25 mm
08-502 60 x 25 mm
Medial Titan blades
semi transparent to x-ray

08-503 40 x 25 mm
08-504 45 x 25 mm
08-505 50 x 25 mm
08-506 55 x 25 mm
08-507 60 x 25 mm
Lateral Titan blades
semi transparent to x-ray



08-508
CLOWARD
155 mm



08-509
CLOWARD
135 mm



08-510
INGE
170 mm

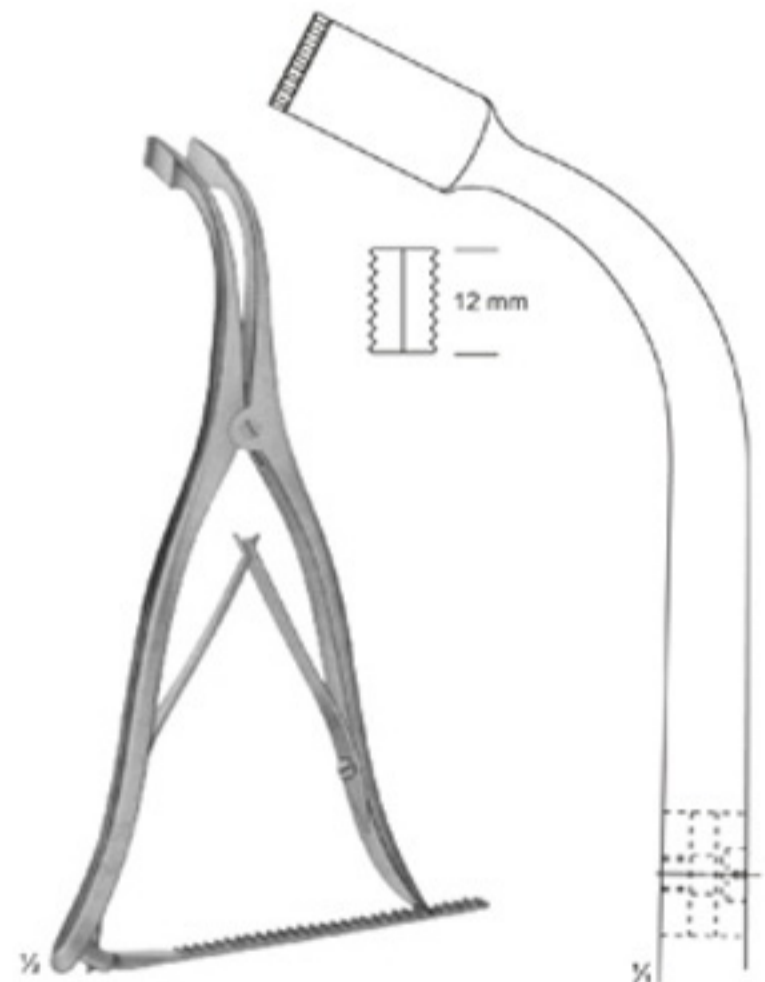

08-511
INGE
275 mm



08-512
BABY-COLLIN
with 2 pair of blades



08-513
COLLIN
complete

08-817 135 mm
08-818 160 mm



08-514 37x62mm
08-515 37x80mm
08-516 37x98mm
08-517 54x55mm
08-518 54x67mm
08-519 58x80mm
08-520 72x84mm

08-514 - 518
COLLIN
complete

210 mm



08-519 - 520
RICARD
complete

08-519 58x80mm
08-520 72x84mm
08-519 54x70mm
08-520 72x90mm

275 mm



08-521 - 523
HOLZBACH
Complete

08-521 59x80mm
08-522 74x82mm
08-523 74x82mm

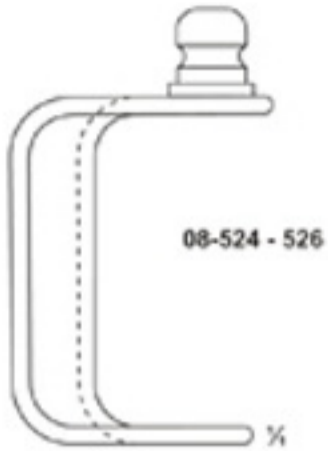

Lateral blades only
 08-524 37x62 mm
 08-525 37x80 mm
 08-526 37x98 mm

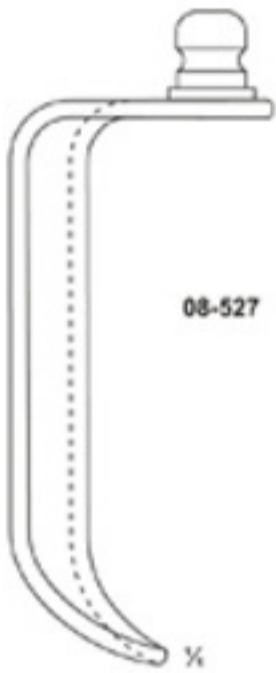

08-527 61x80 mm

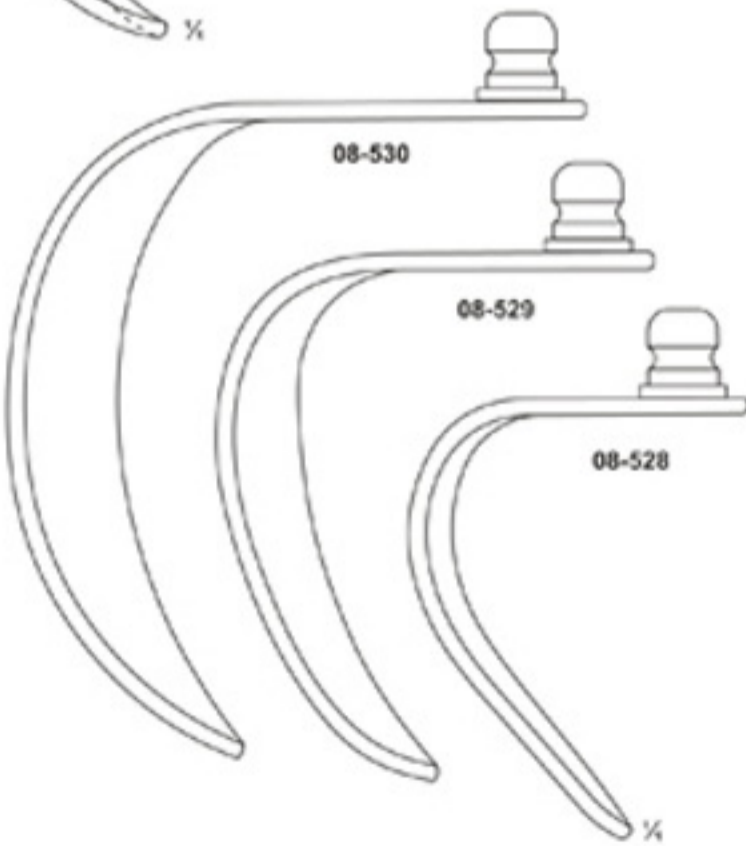

08-528 48x59 mm
 08-529 58x80 mm
 08-530 72x84 mm





08-532
GOSSET
Blades: 38 mm deep



08-533
HERTZLER
Blades 20 X 25 mm

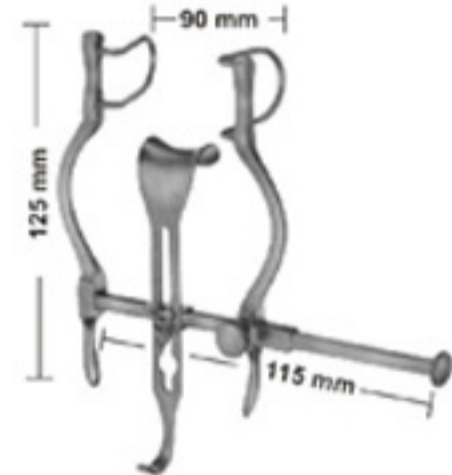

08-534
BALFOUR-BABY
Lateral blades 27 mm deep
Center blade 21x24 mm

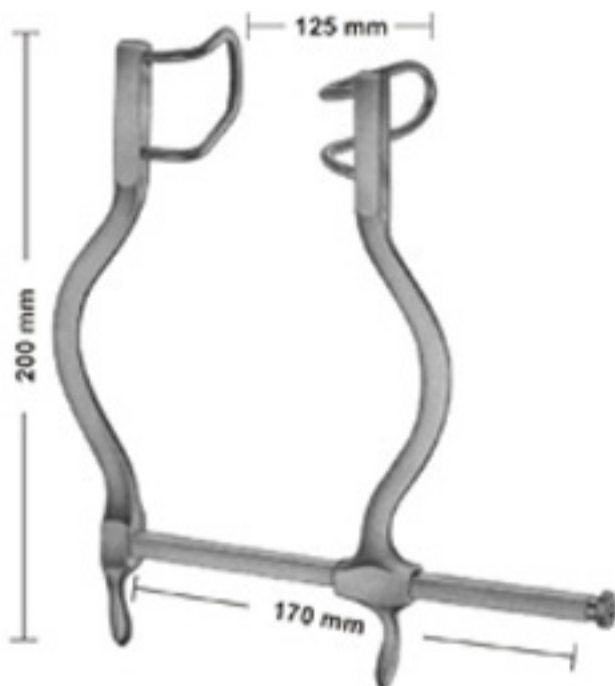

08-535
GOSSET
Blades: 55mm deep

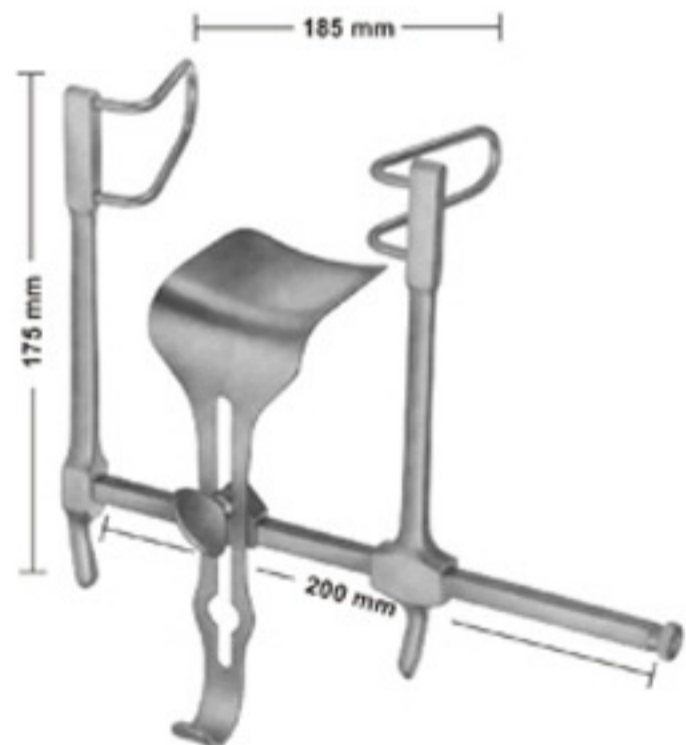

08-536
GOSSET
Lateral blades 58 mm deep
Center blade 59 x 57 mm

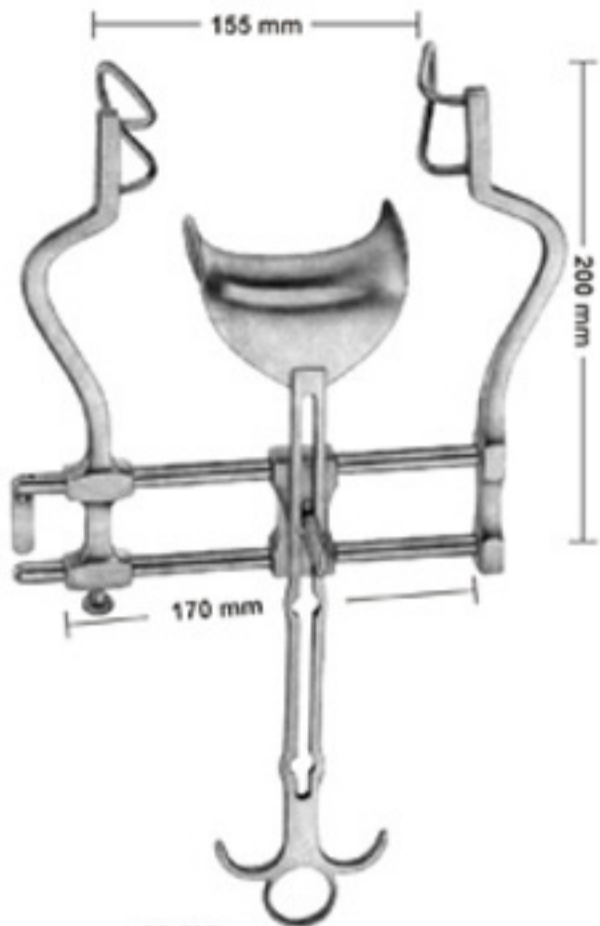

08-537
BALFOUR
Lateral blades 60 mm deep
Center blade 47 x 80 mm

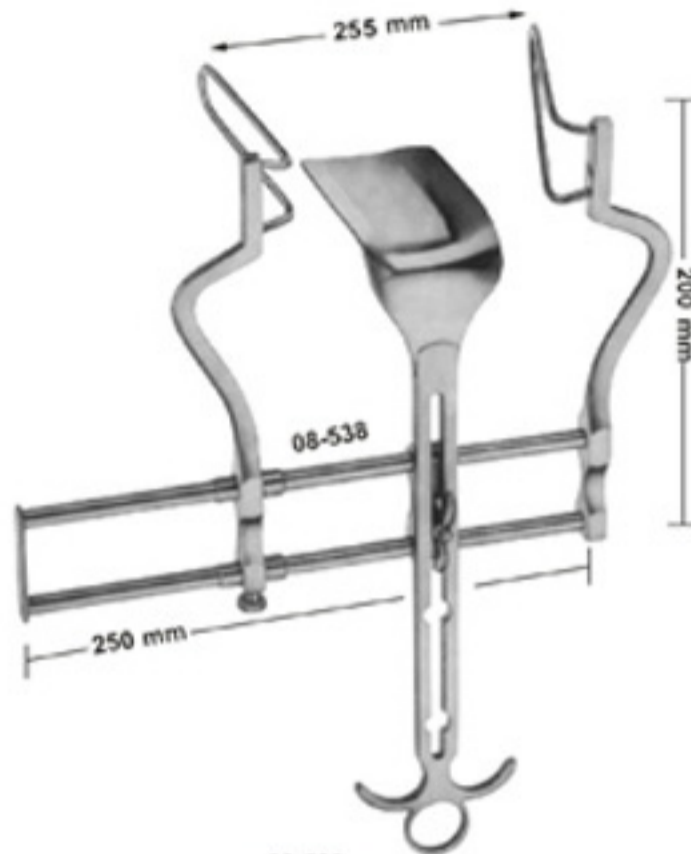

08-538
BALFOUR
Lateral blades 105 mm deep
Center blade 107x 59 mm



08-539
Center blade only
54x80 mm

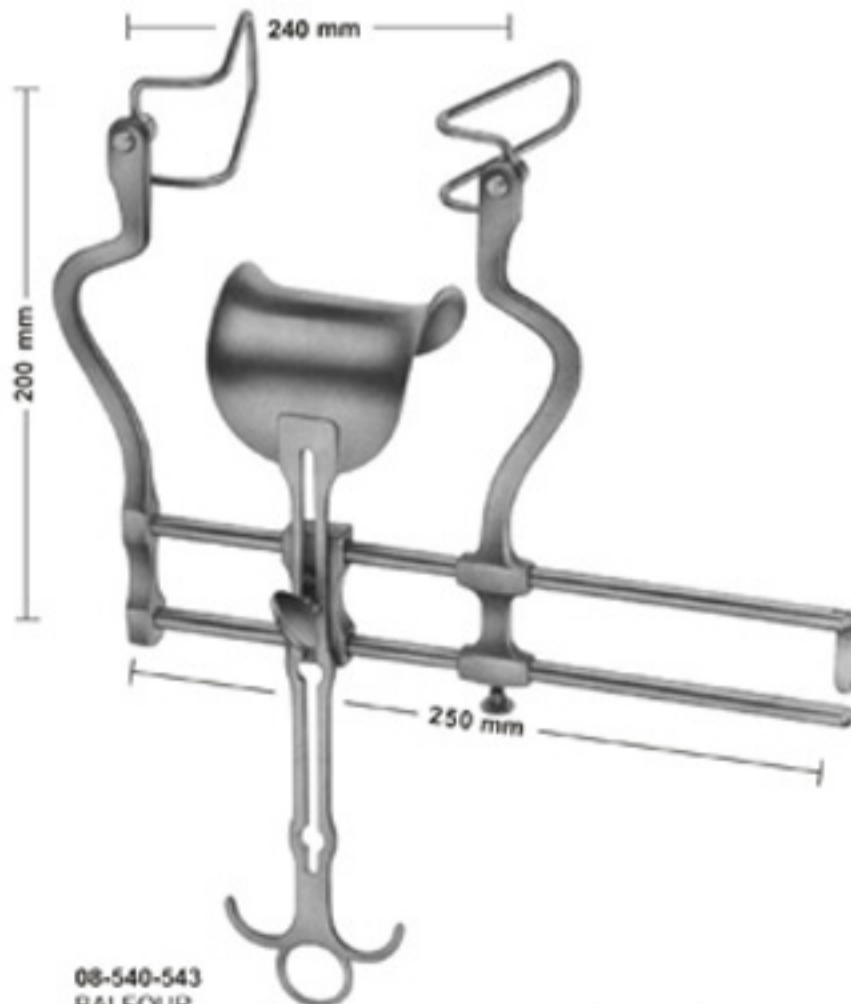

08-540-543
BALFOUR
Spreader only 08-540 08-541 08-542 08-543
Lateral blades 50 mm 60 mm 75 mm 90 mm
Center blade 47 x 80 mm 62x76 mm 80x80 mm 80x80 mm



Sales Unit of blades: PR = pair

Lateral blades
08-544 50 mm deep
08-545 60 mm deep
08-546 75 mm deep
08-547 90 mm deep

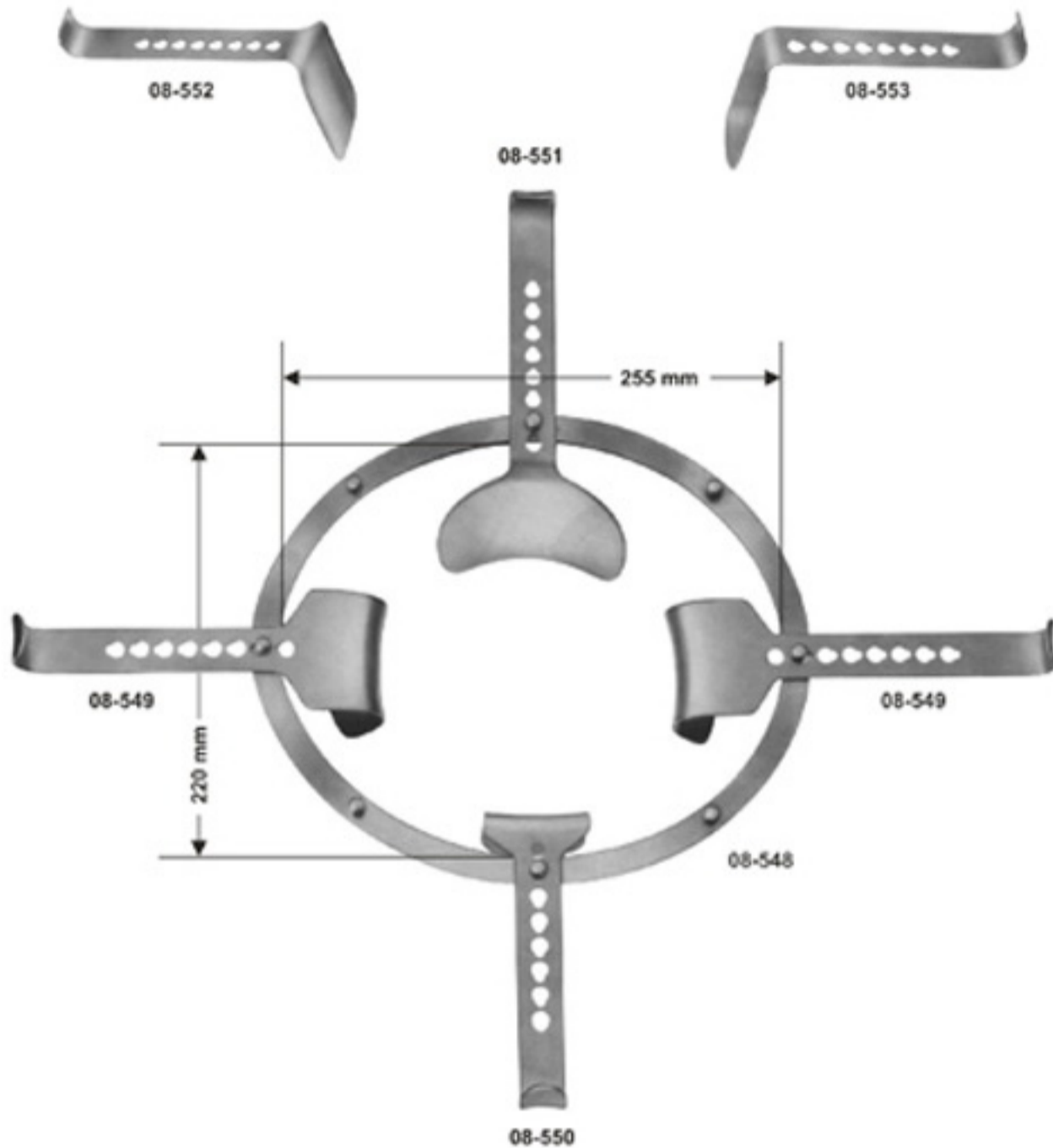

08-548 - 08-553

SEMM

consisting of:

- 08-548 1 frame 225 x 220 mm
- 08-549 2 blades 46 x 64 mm
- 08-550 1 blade 53 x 54 mm
(for bladder)
- 08-551 1 blade 82 x 97 mm
(for intestine)
- 08-552 1 blade 98 x 51 mm
(for intestine)
- 08-553 1 blade, narrow
107 x 36 mm

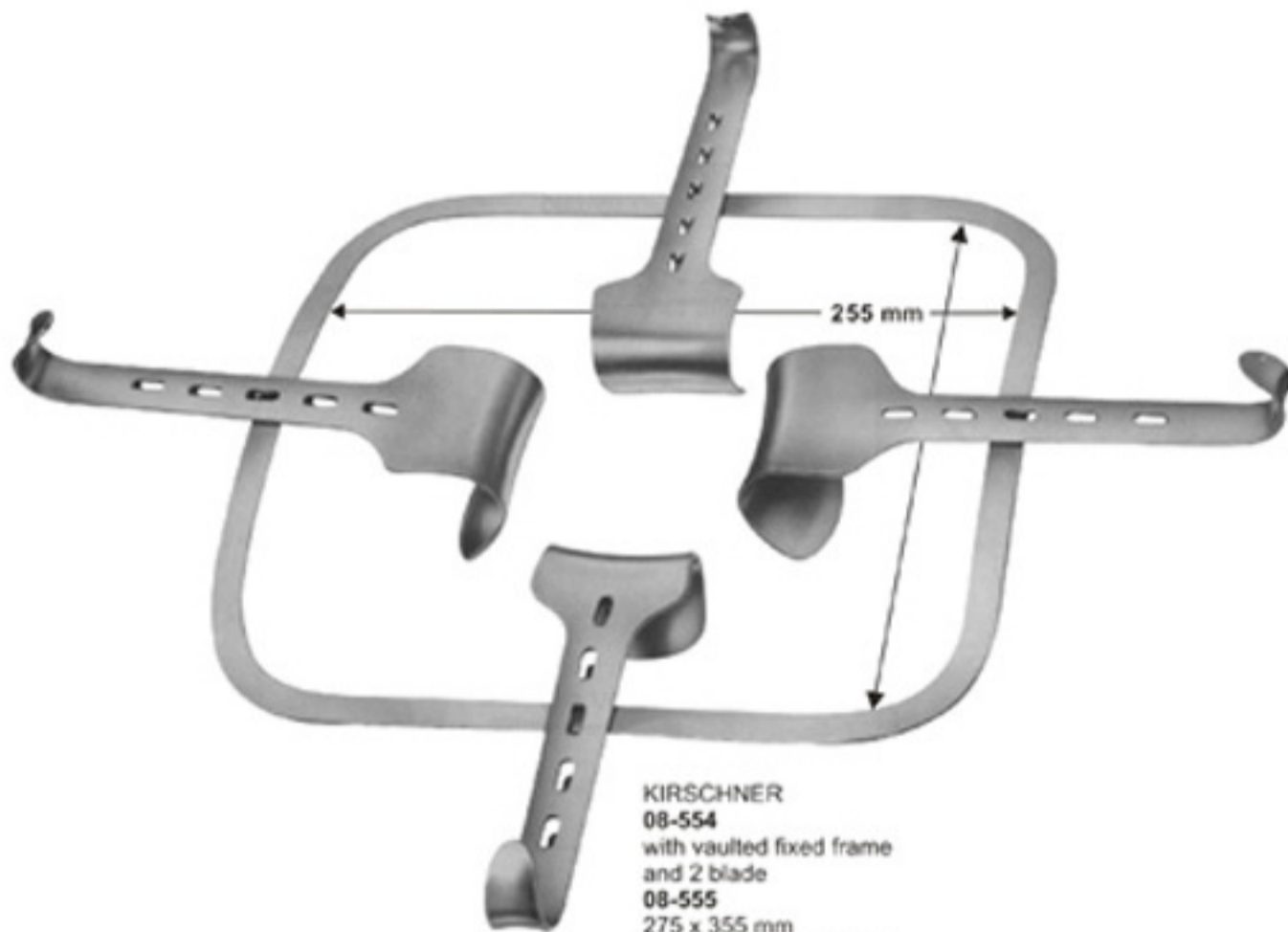

KIRSCHNER
08-554
 with vaulted fixed frame
 and 2 blade
08-555
 275 x 355 mm
 Frame only, over-sized
08-556
 295 x 275 mm
 Frame only



08-557
KIRSCHNER
 64 x 80 mm



08-558
KIRSCHNER-BALFOUR
 80x 82 mm



08-559 - 561
KIRSCHNER
08-559 90x 69mm
08-560 92x 95mm
08-561 78x 58mm



08-562 - 564
KIRSCHNER
08-562 108x42mm
08-563 91x 55mm
08-564 121x 55mm



09-101
CHAPUT
 2 X 3 teeth, sharp
 125 mm,



09-102
TUFFIER
 5 X 6 teeth, sharp
 125 mm,



09-103
BOYS-ALLIS
 5 X 6 teeth, sharp
 155 mm,



09-104
ALLIS
 4 X 5 teeth
 155 mm,

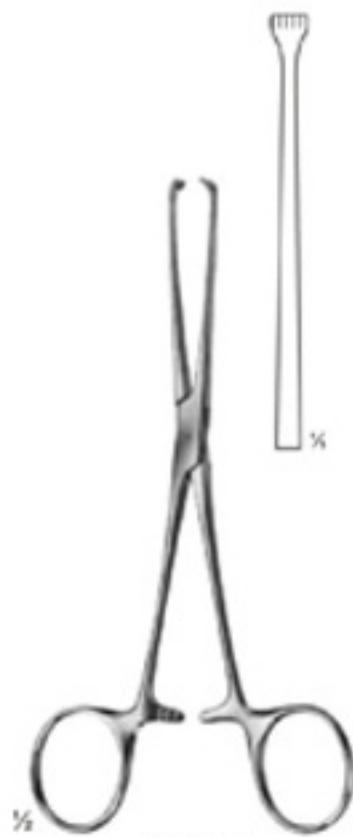

09-105
ALLIS
 155 mm,
 4 X 5 teeth

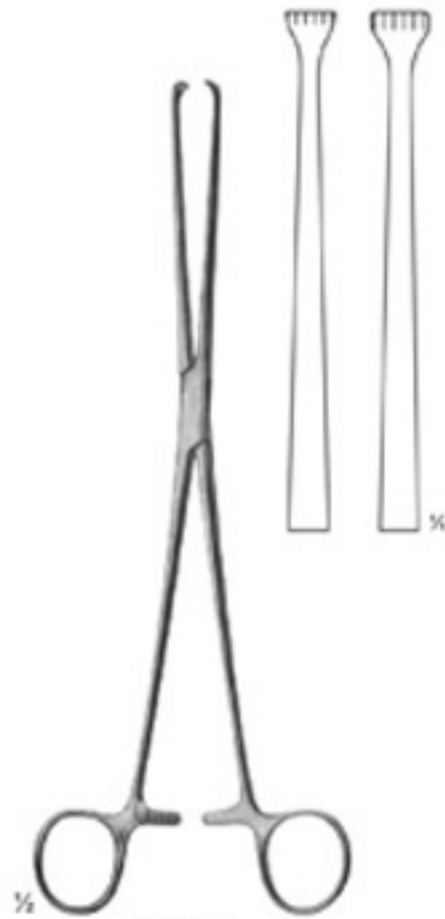

09-106
ALLIS
 190 mm,
09-107
 255 mm,
 5 X 6 teeth



09-108
JUDD-ALLIS
 3 X 4 teeth
 195 mm,

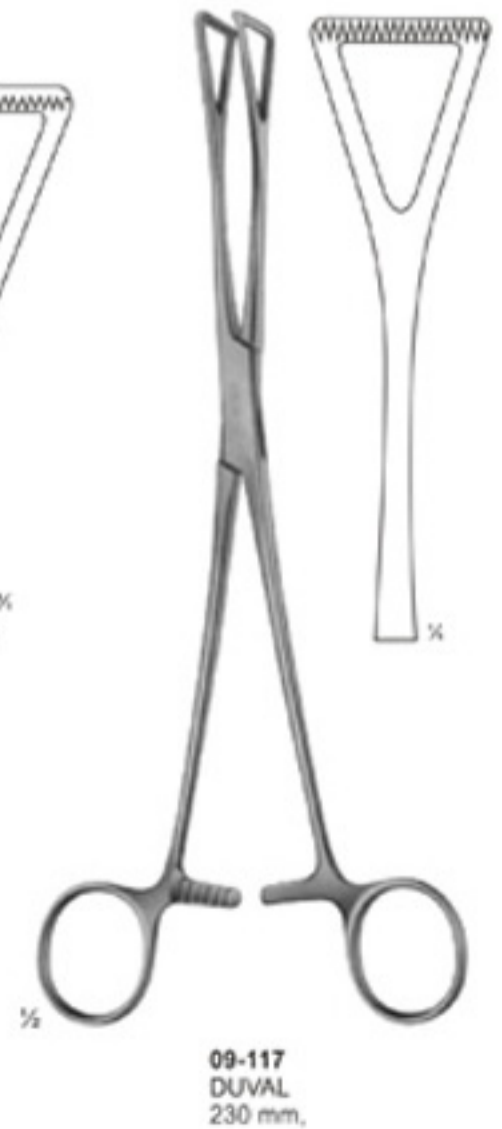
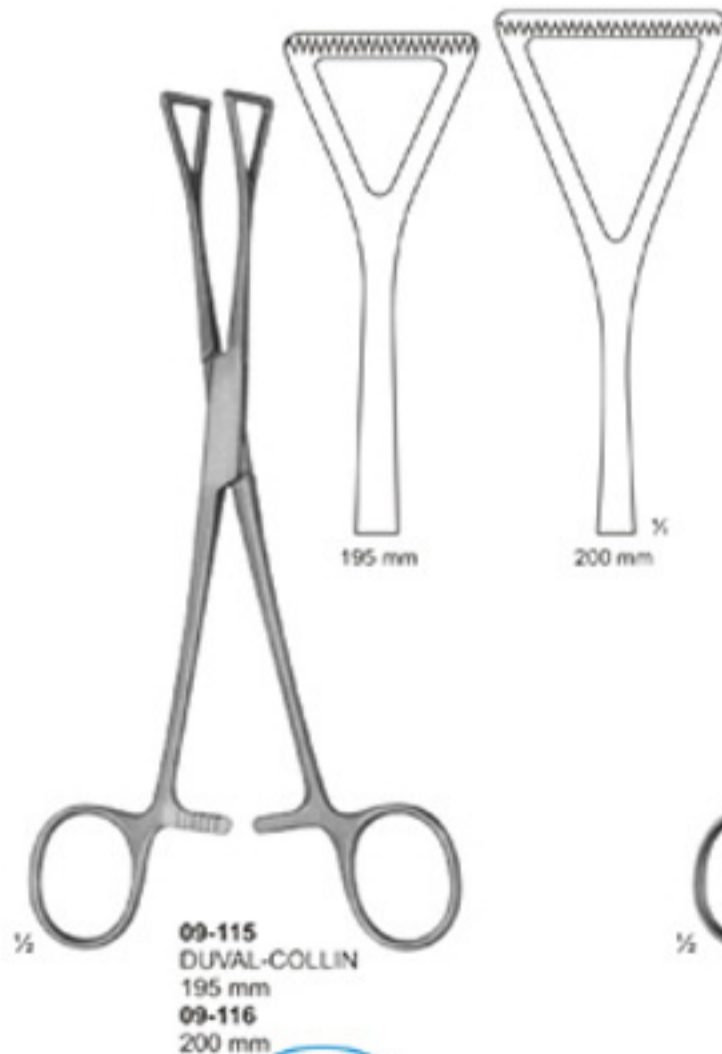
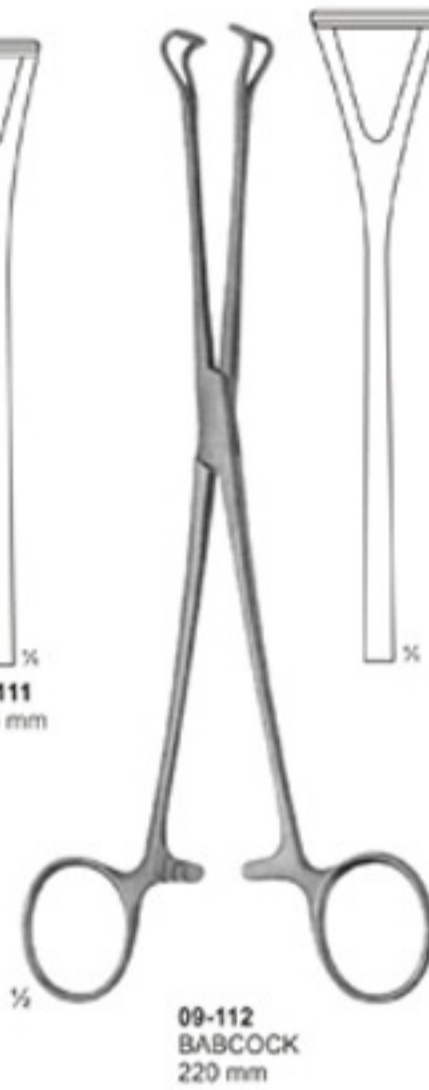
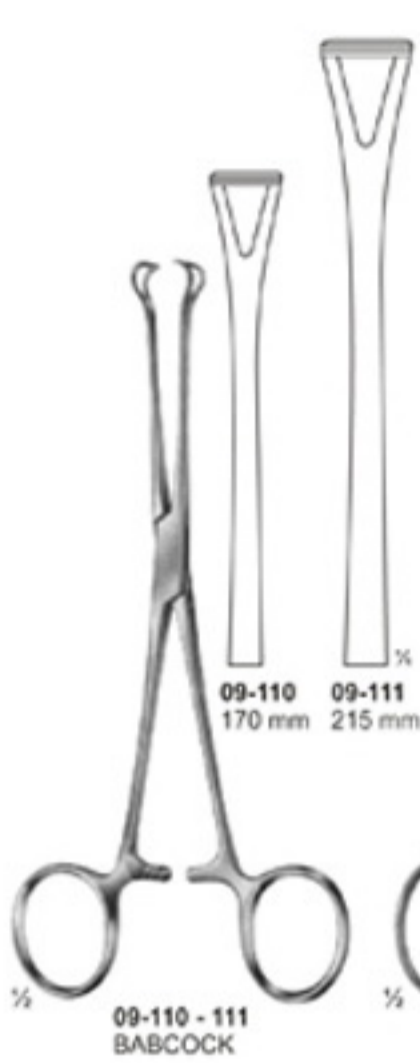



09-118-120
LANE

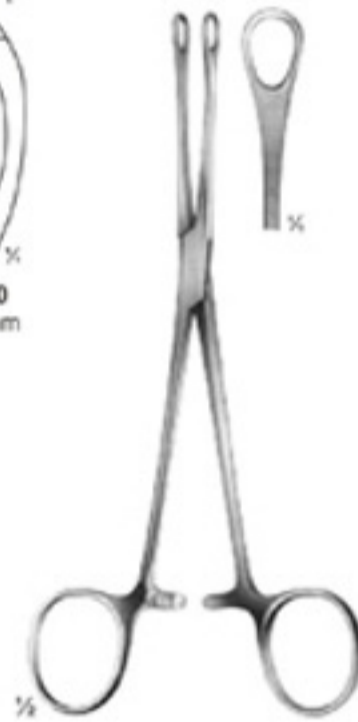

09-121
WILLIAMS
160 mm



09-122
DENIS
BROWNE
190 mm

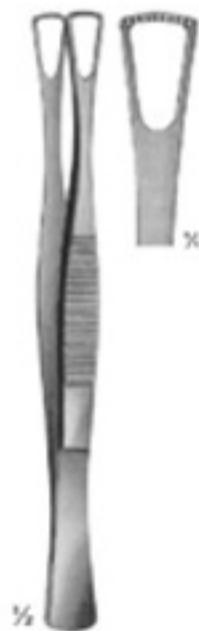

09-123
DUVAL
140 mm



09-124
WANGENSTEEN
150 mm
09-125
230 mm



09-126
WANGENSTEEN
150 mm
09-127
230 mm

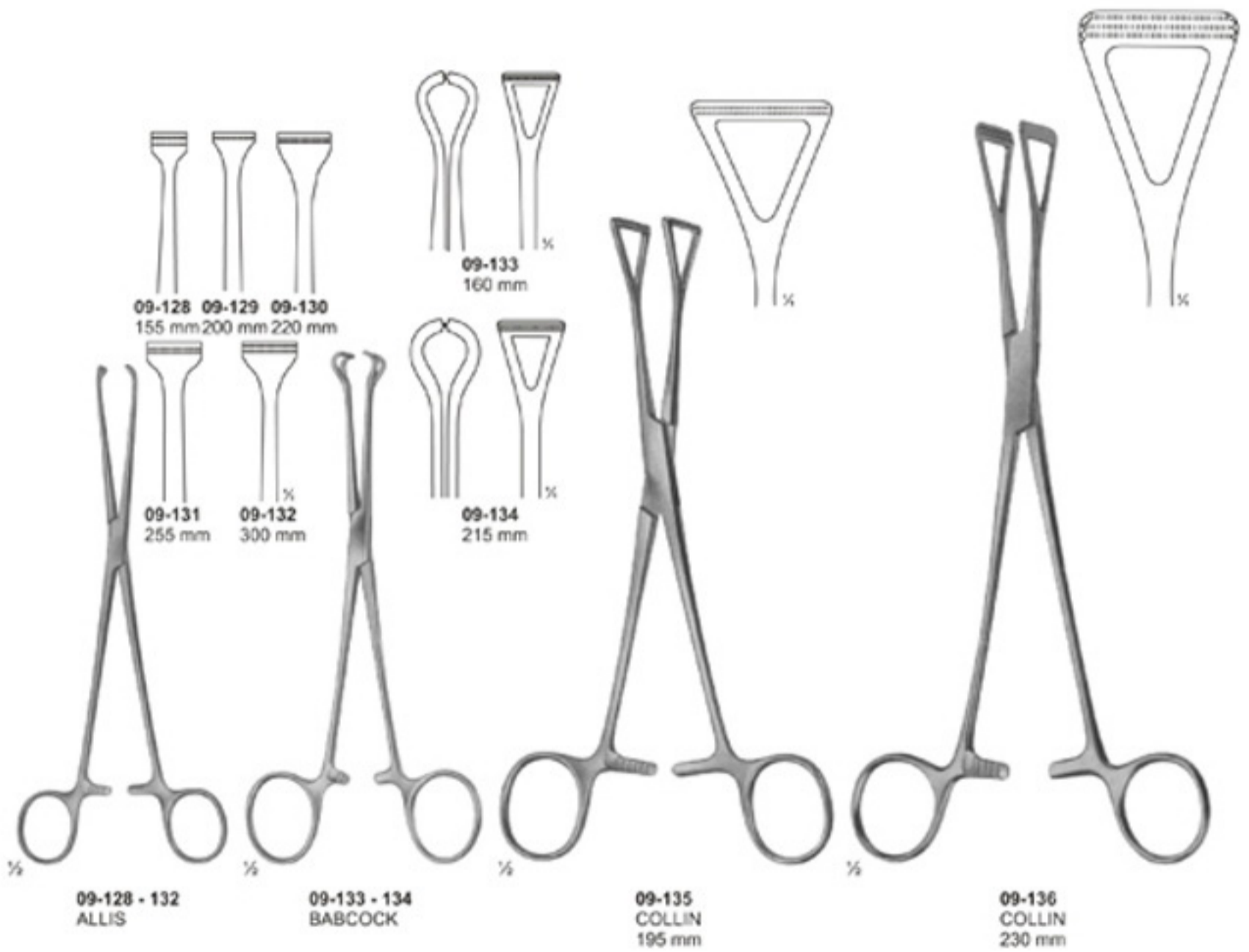



09-137 150 mm
 09-138 200 mm
 09-139 240 mm
 09-140 300 mm



DE BAKEY
 09-141 150 mm
 09-142 200 mm
 09-143 240 mm
 09-144 300 mm

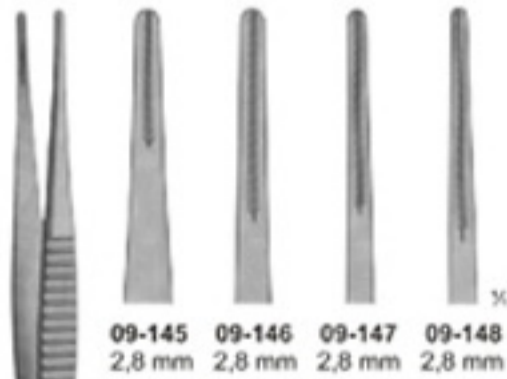

DE BAKEY
 09-145 150 mm
 09-146 200 mm
 09-147 240 mm
 09-148 300 mm

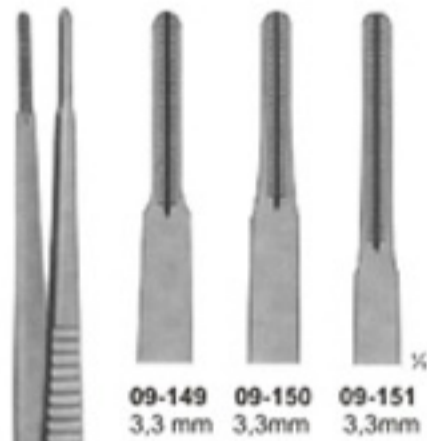

DE BAKEY
 09-149 200 mm
 09-150 240 mm
 09-151 300 mm

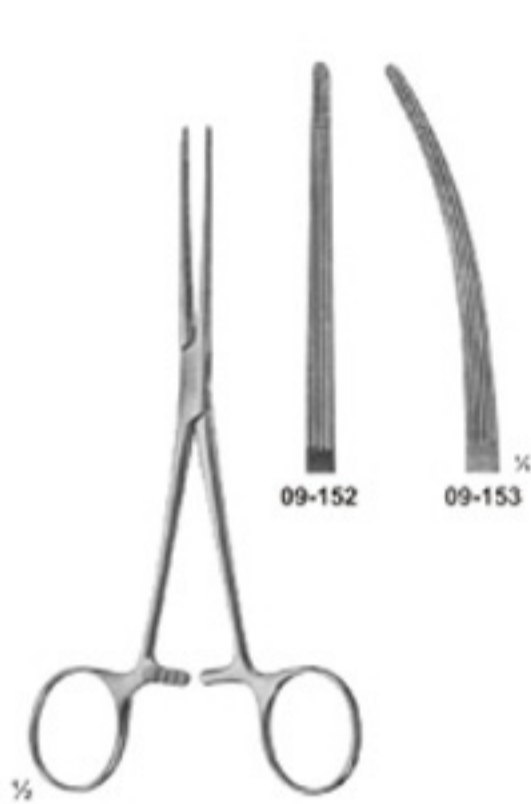

09-152 - 153
BAINBRIDGE
155 mm



09-154
ALLEN
155 mm

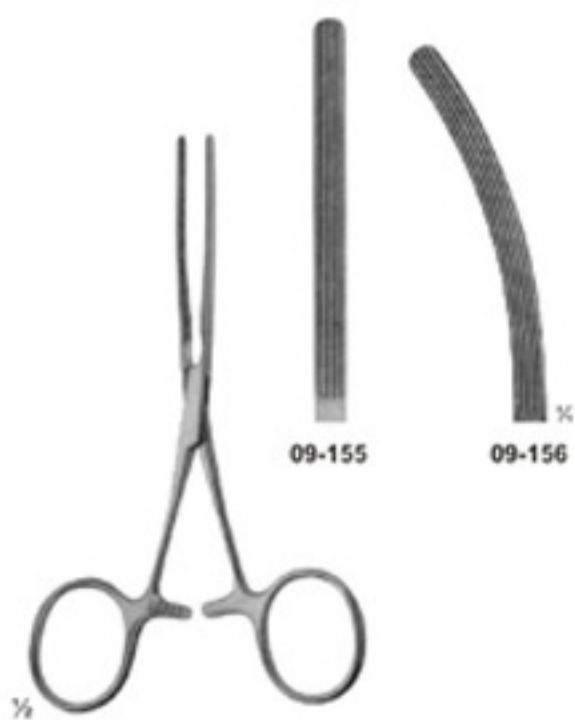

09-155 - 156
BABY-KOCHER
very elastic blades
130 mm

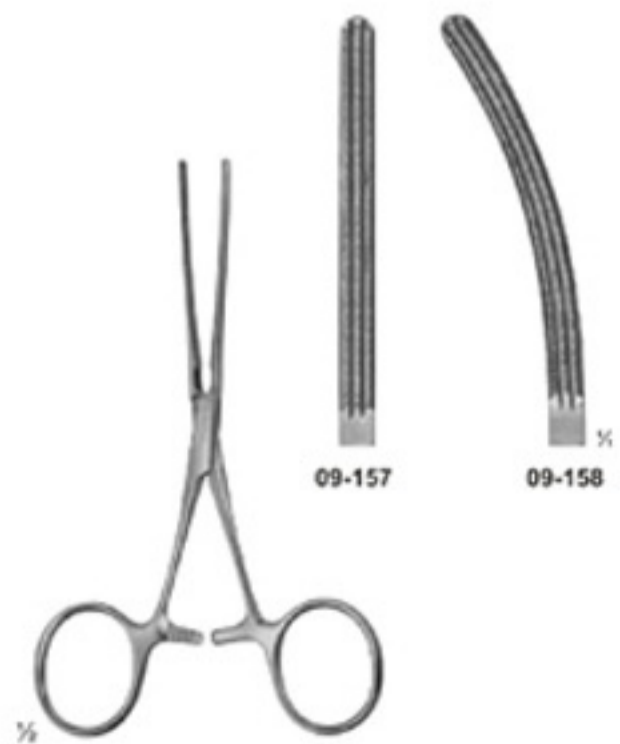

09-157 - 158
BABY-KOCHER
with elastic blades
130 mm

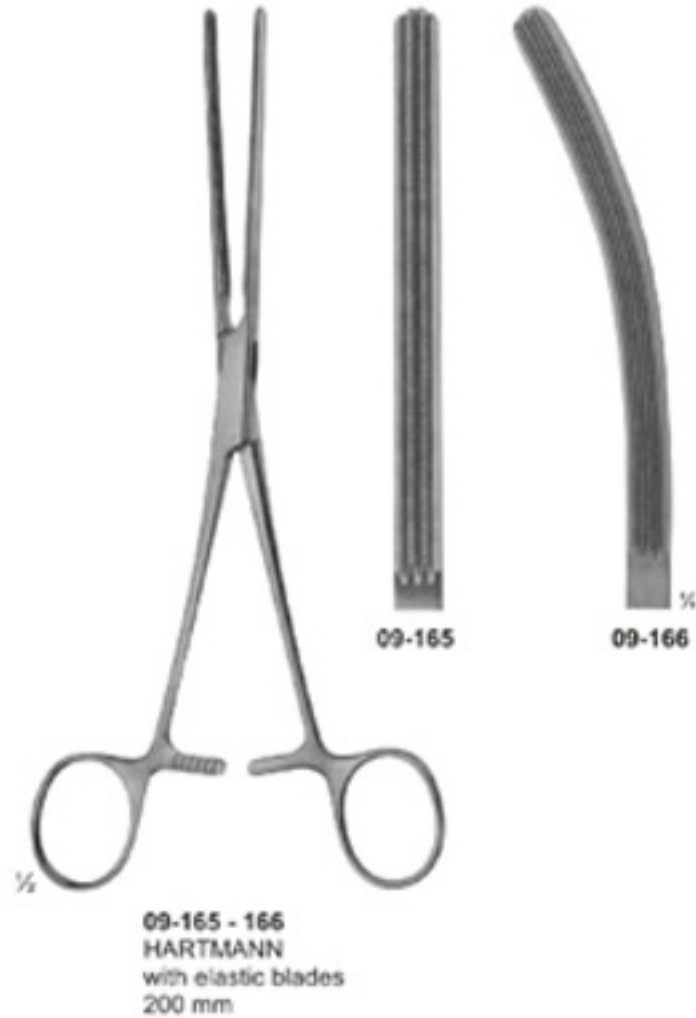
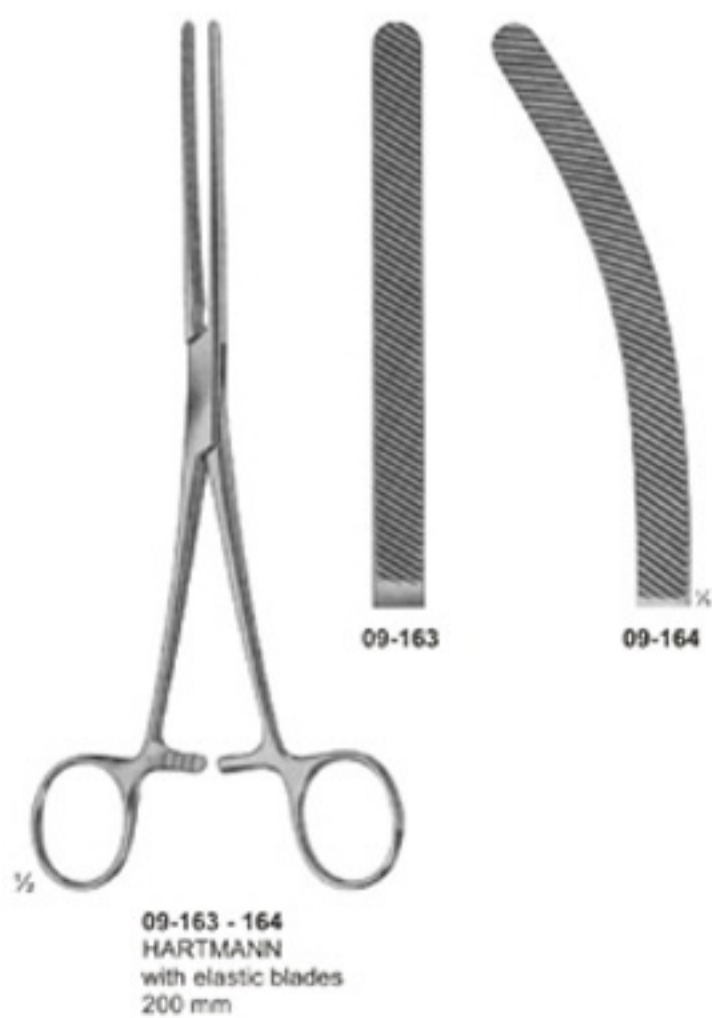
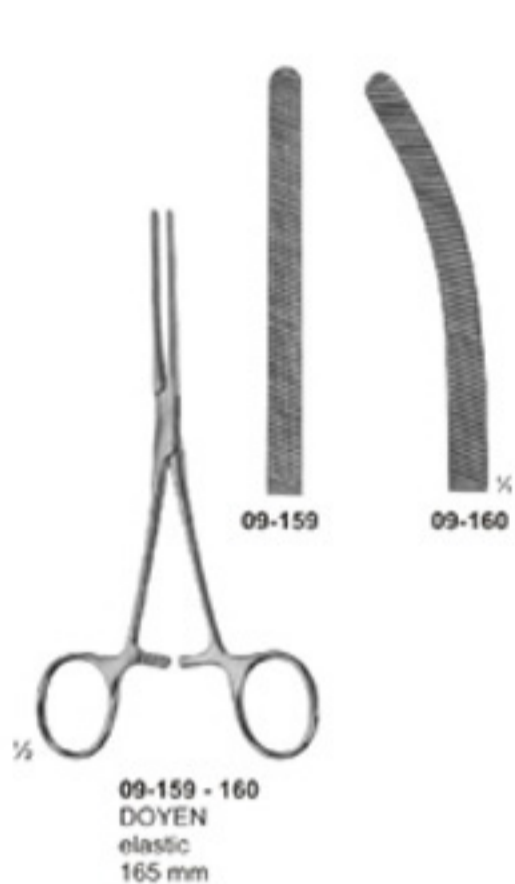

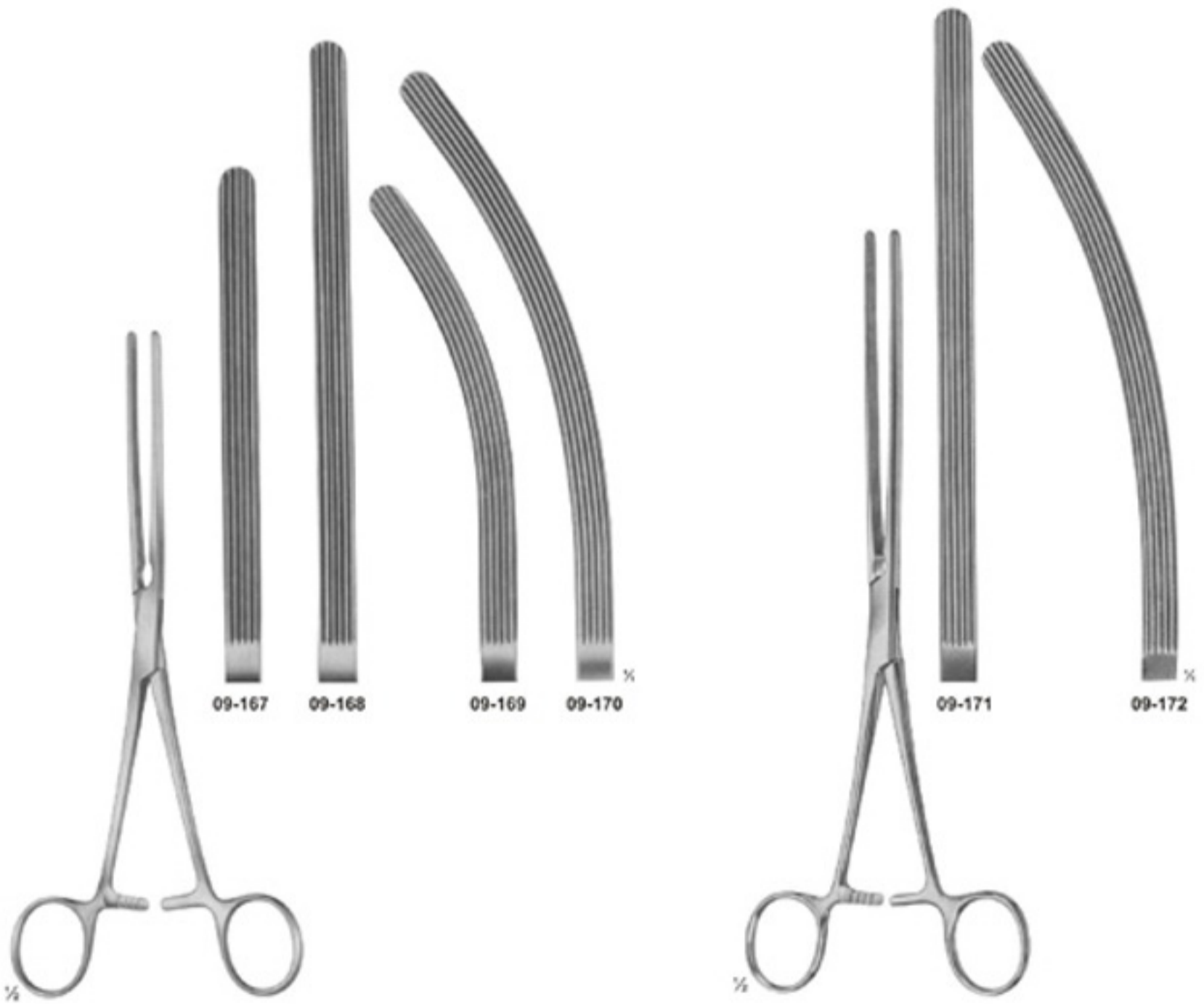

09-167 - 170
KOCHER
 with elastic blades
09-169 210 mm
09-170 230 mm

09-171 - 172
DOYEN
 with elastic blades
 210 mm

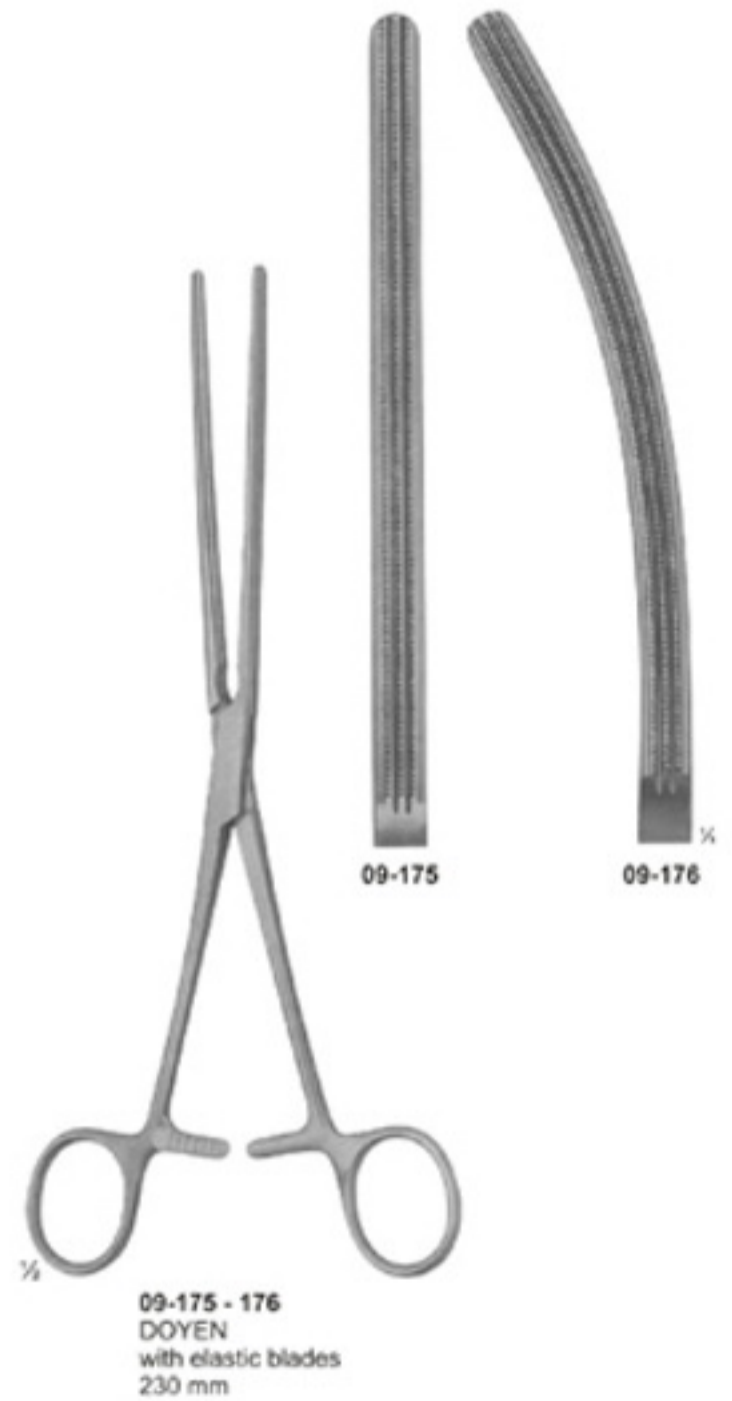
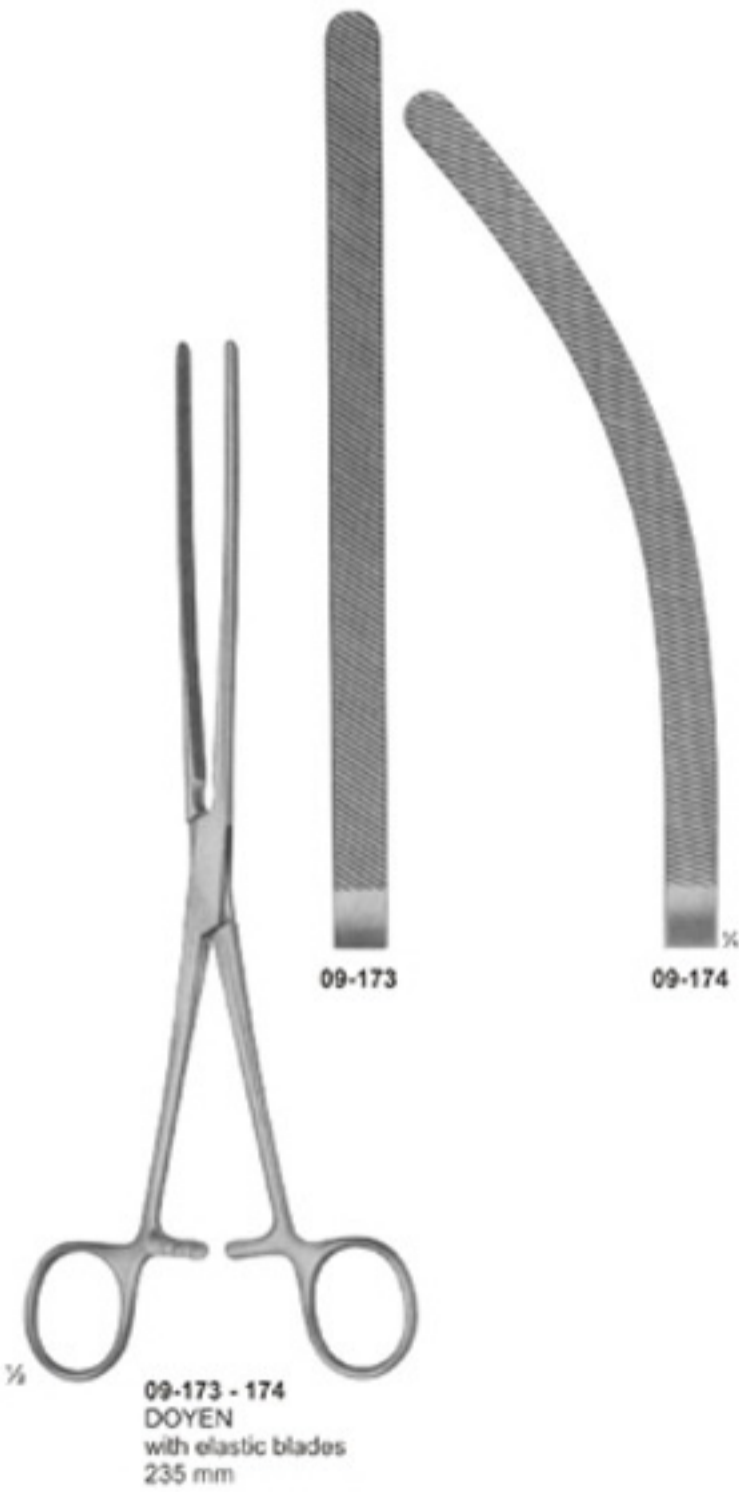

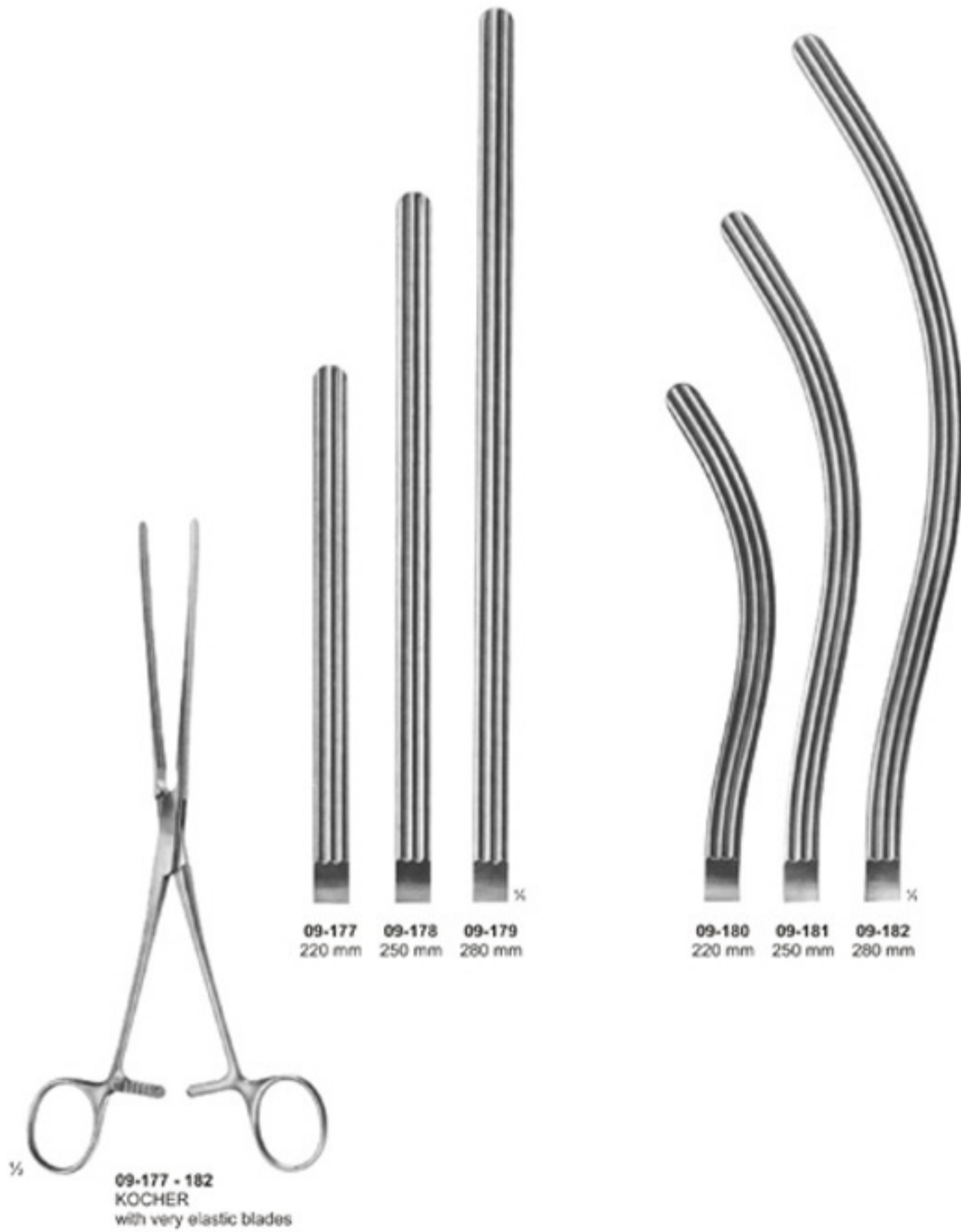

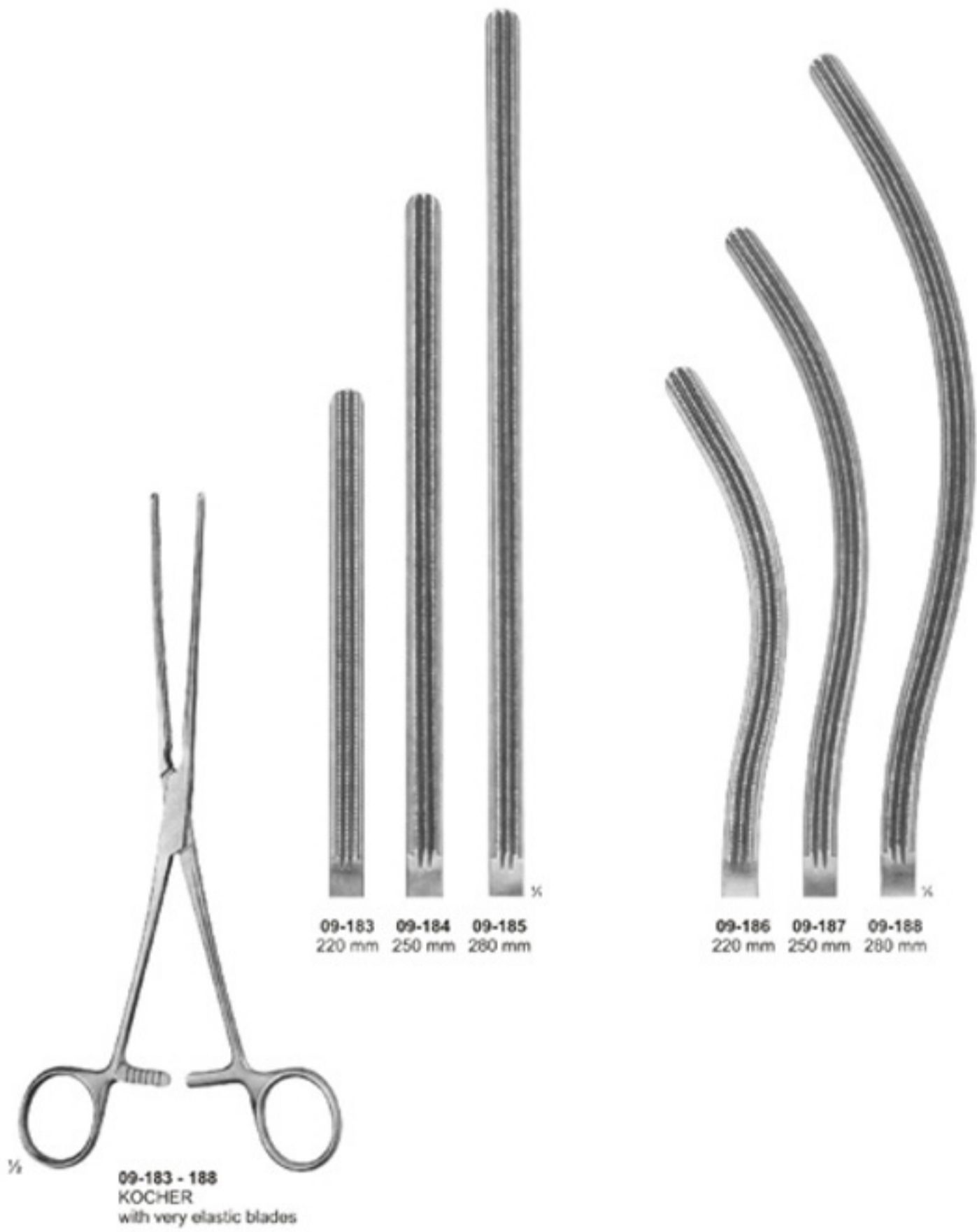

1/2
09-183 - 188
KOCHER
 with very elastic blades

09-183 220 mm
09-184 250 mm
09-185 280 mm

09-186 220 mm
09-187 250 mm
09-188 280 mm



09-189

09-190

09-189 - 190
NUSSBAUM
 with elastic blades
 250 mm

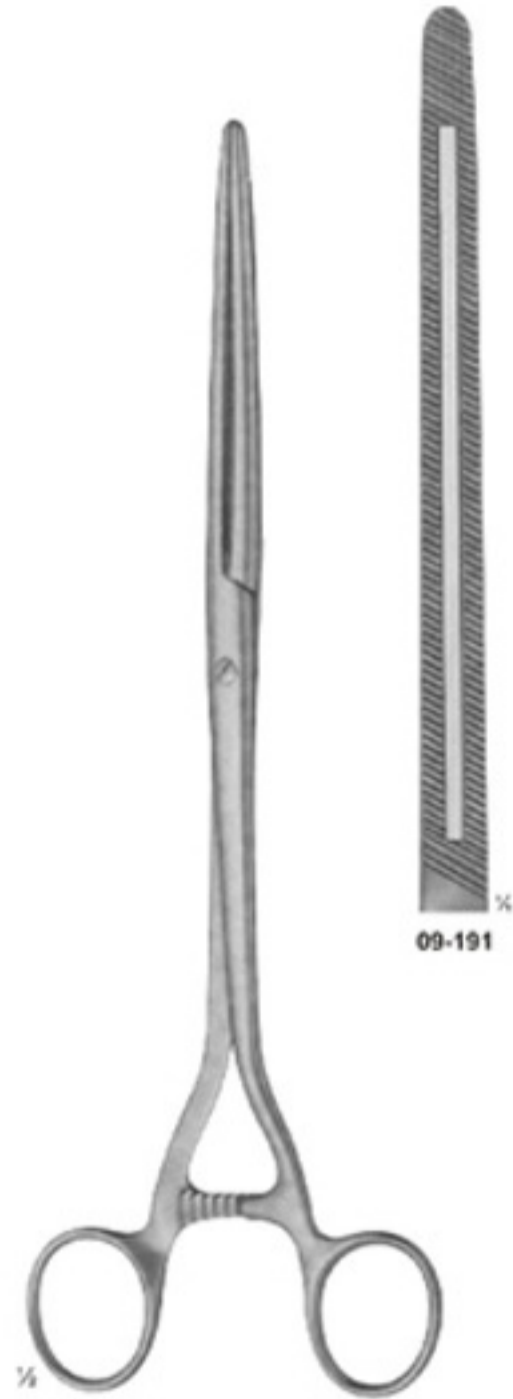

09-191

09-191
MOYNIHAN
 280 mm

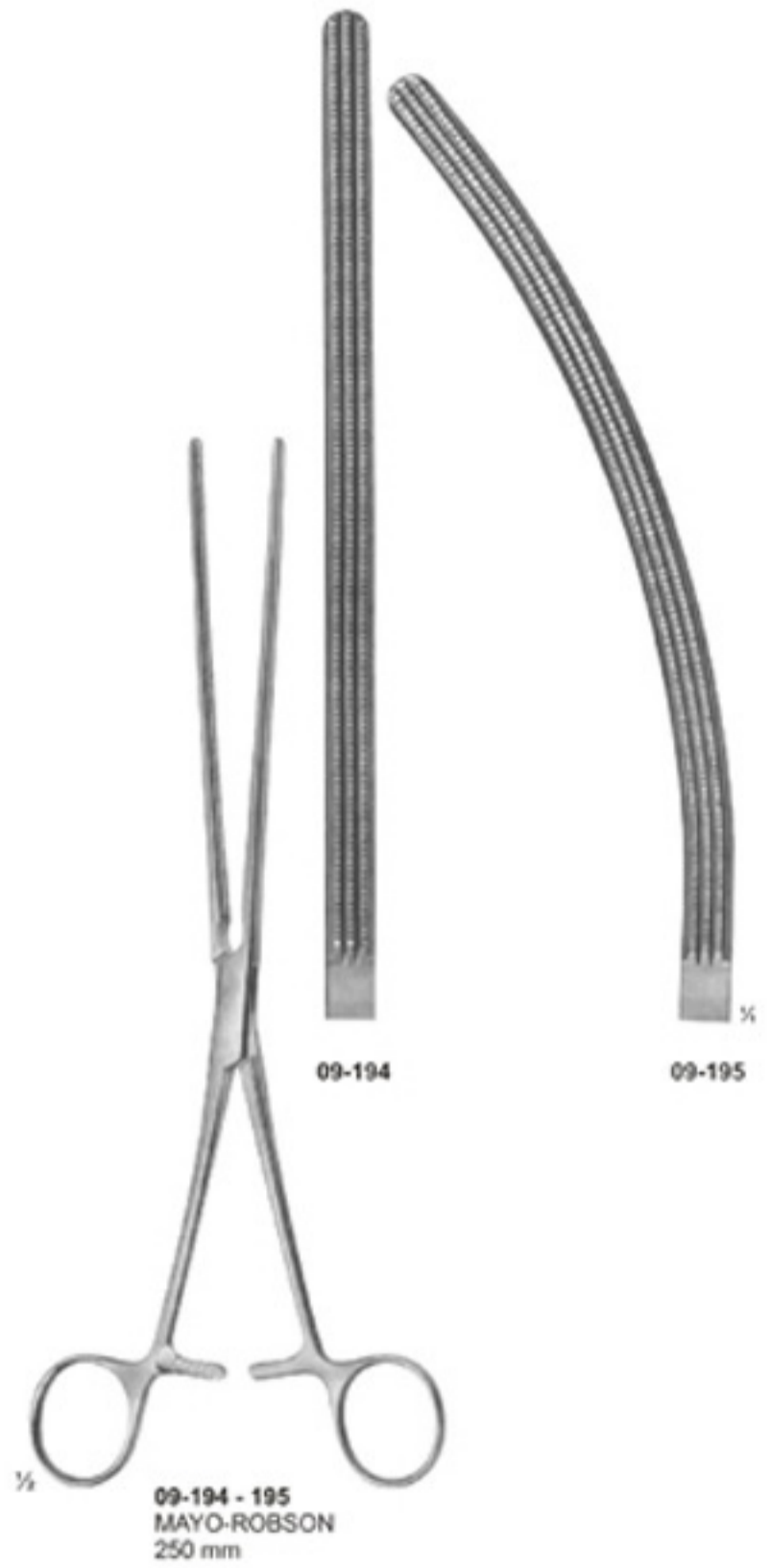
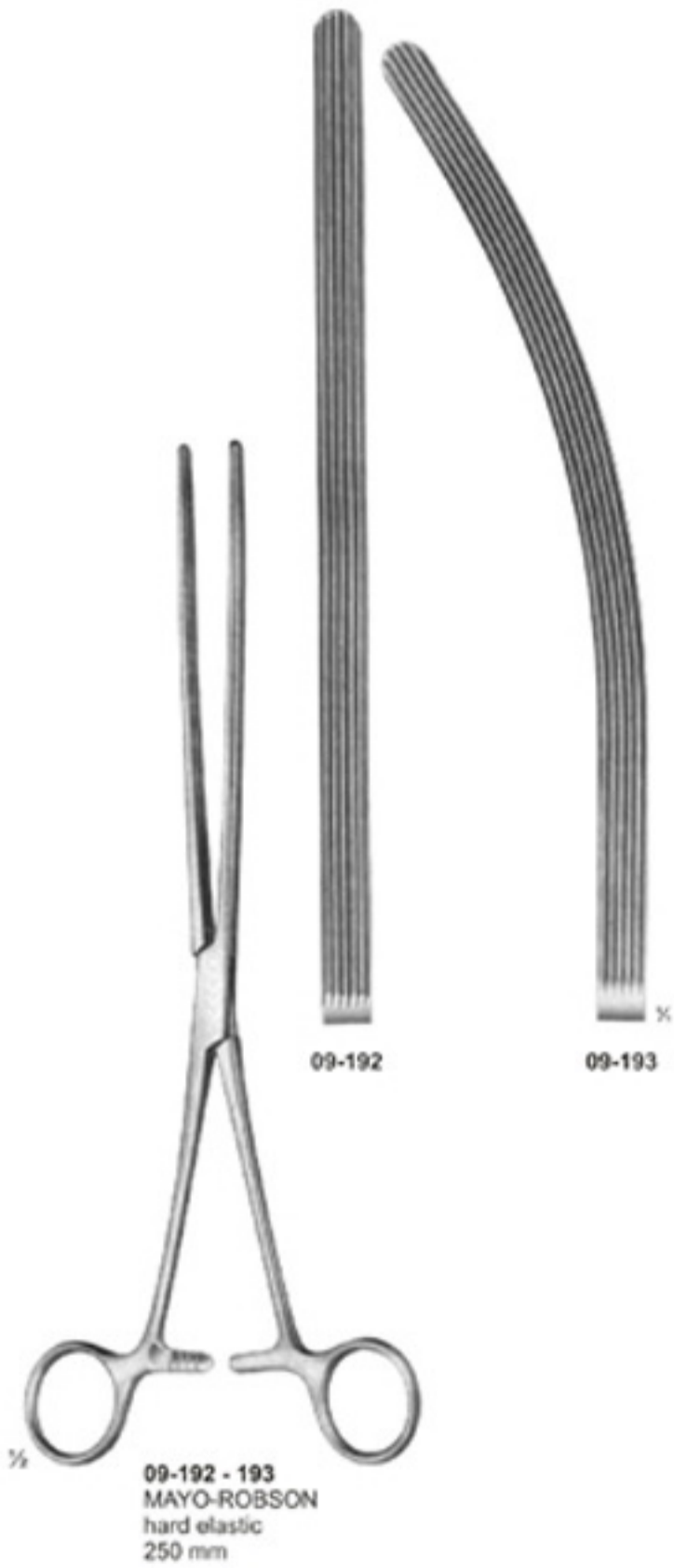



09-196
LANE
300 mm

09-197
LANE
300 mm





09-201
PAYR
Intestinal clamp
light pattern,
for children
180 mm

09-202
PAYR
200 mm

09-203
PAYR
275 mm

09-204
PAYR
Pylorus clamp
315 mm



09-205
PARKER-KERR
 anastomosis forceps
 for colon resection
 180 mm

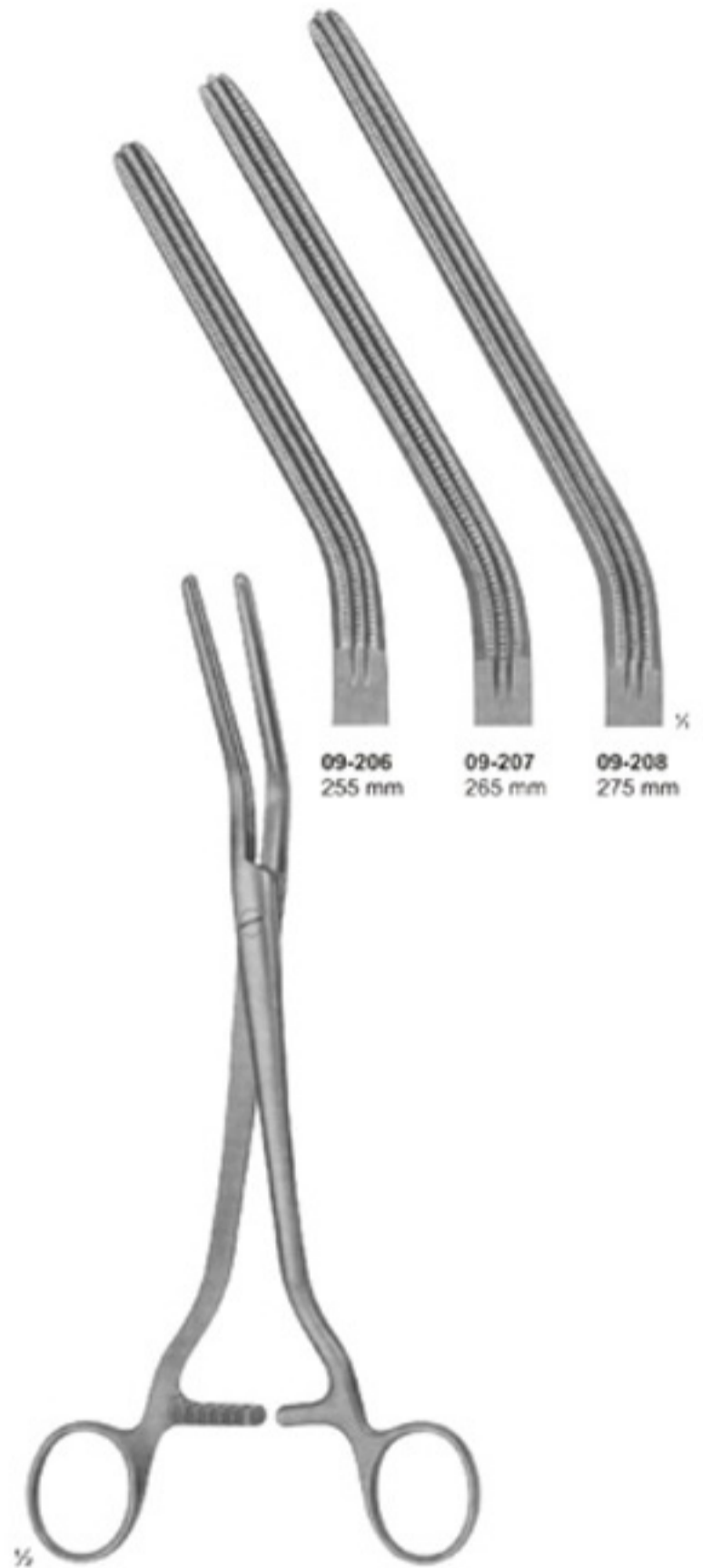

09-206 255 mm
09-207 265 mm
09-208 275 mm

09-206 - 208
DICK
 pressure clamps
 180 mm



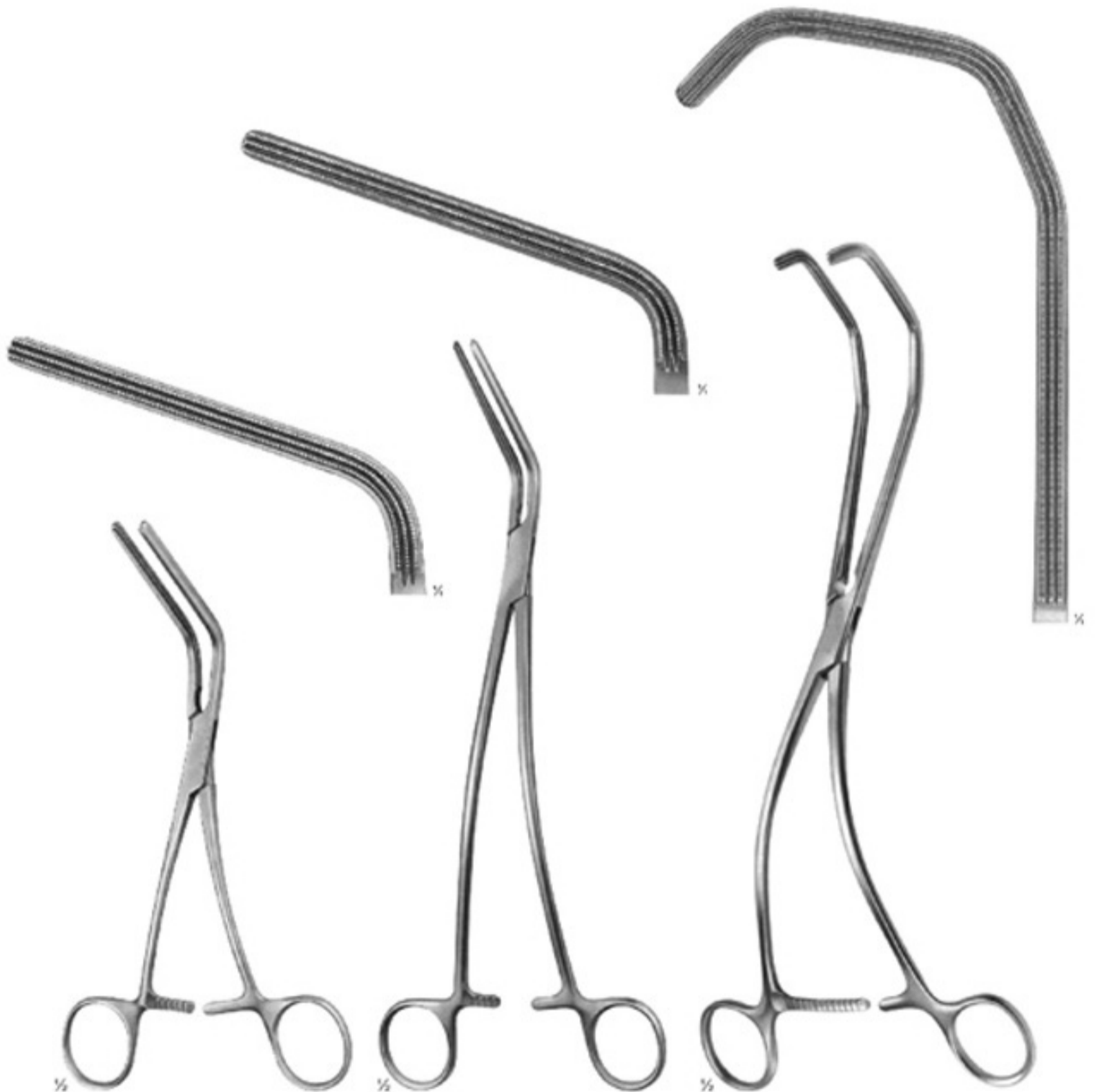

09-212
MORRIS
175 mm

09-213
DE BAKEY
(MORRIS modif.)
240 mm

09-214
KERSTING
270 mm

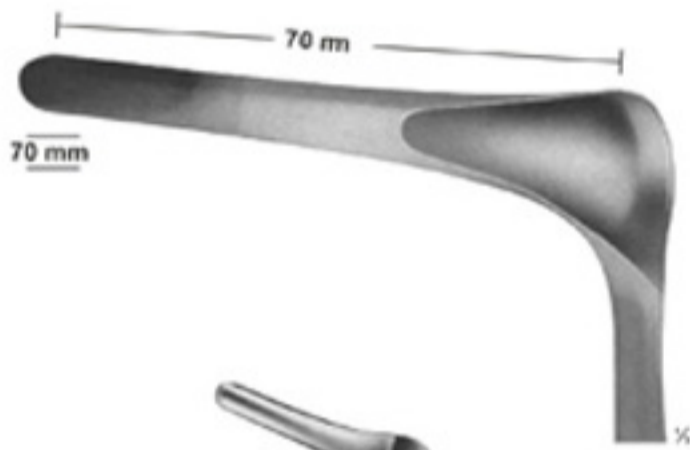

10-101
KILLIAN
for children
145 mm



10-102
SIMS
160 mm



10-103
SIMS
160 mm



10-104 - 107



10-104
SIMS
for children
190 mm

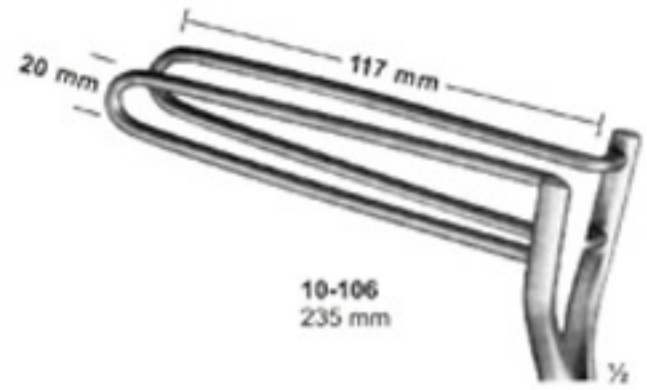

10-106
235 mm

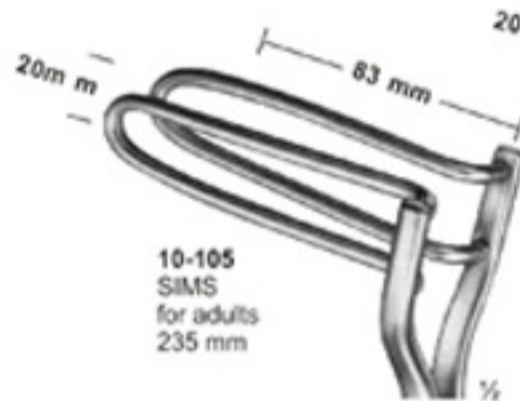

10-105
SIMS
for adults
235 mm

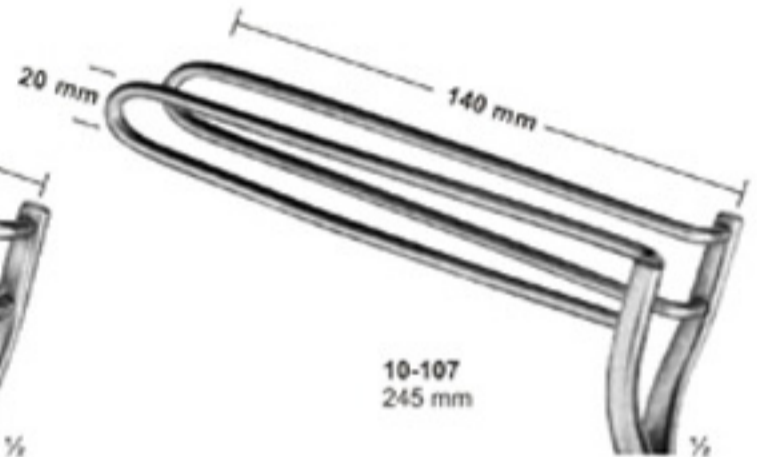

10-107
245 mm



10-108
PRATT
205 mm

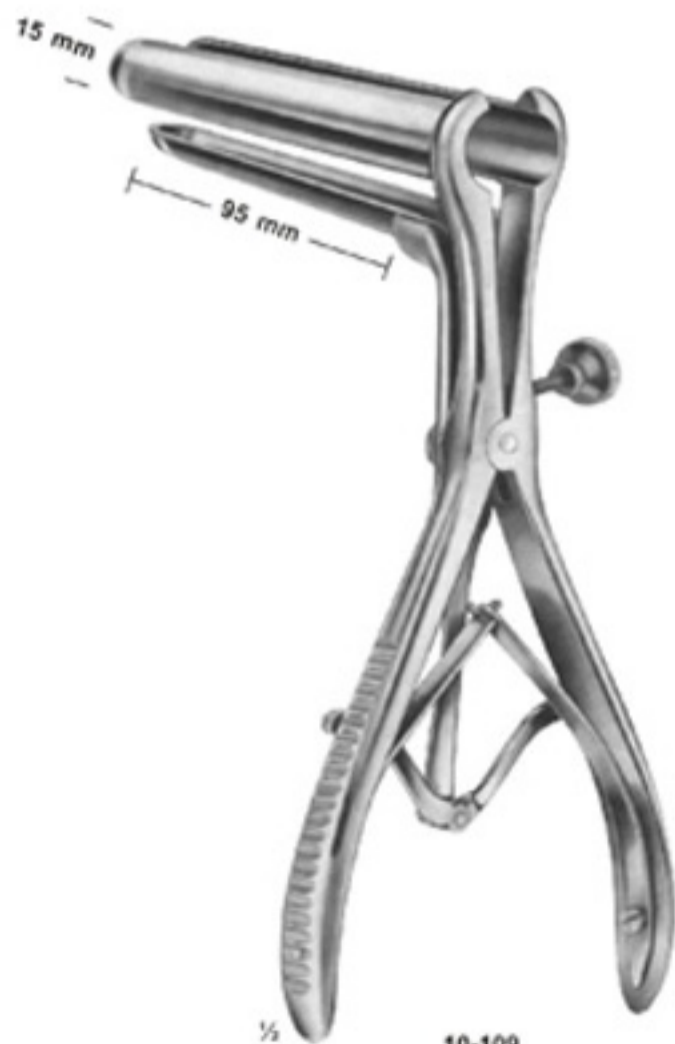

10-109
MATHIEU
215 mm



10-110
IVES-FANSLER
Anuscops
145 mm



10-111
KELLY
Sphincteroscope
160 mm



10-112
KELLY
Sphincteroscope
160 mm

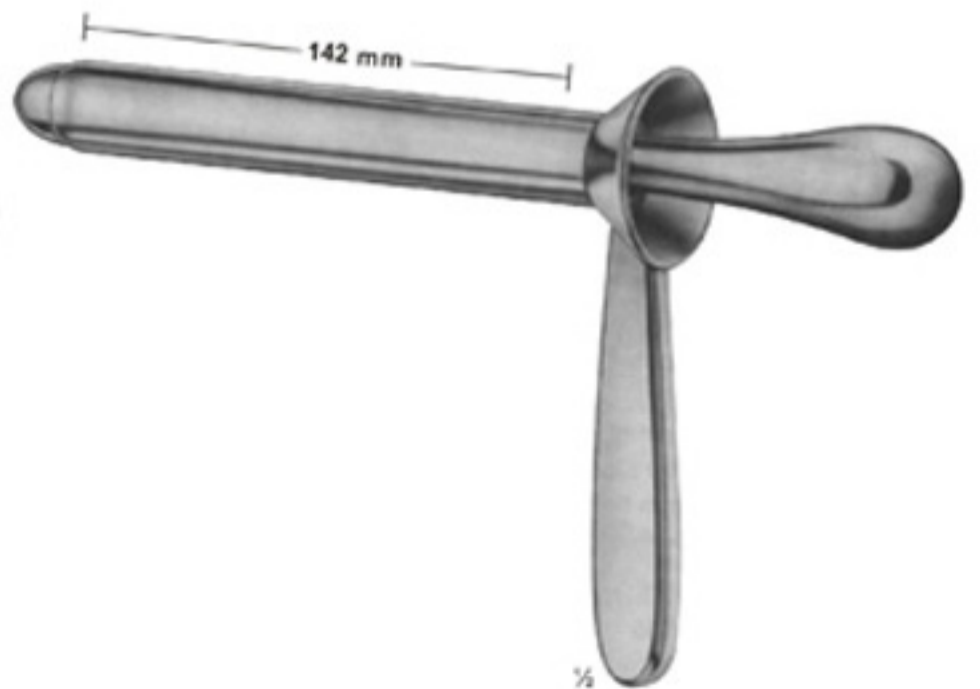

10-113
KELLY
Proctoscope
160 mm

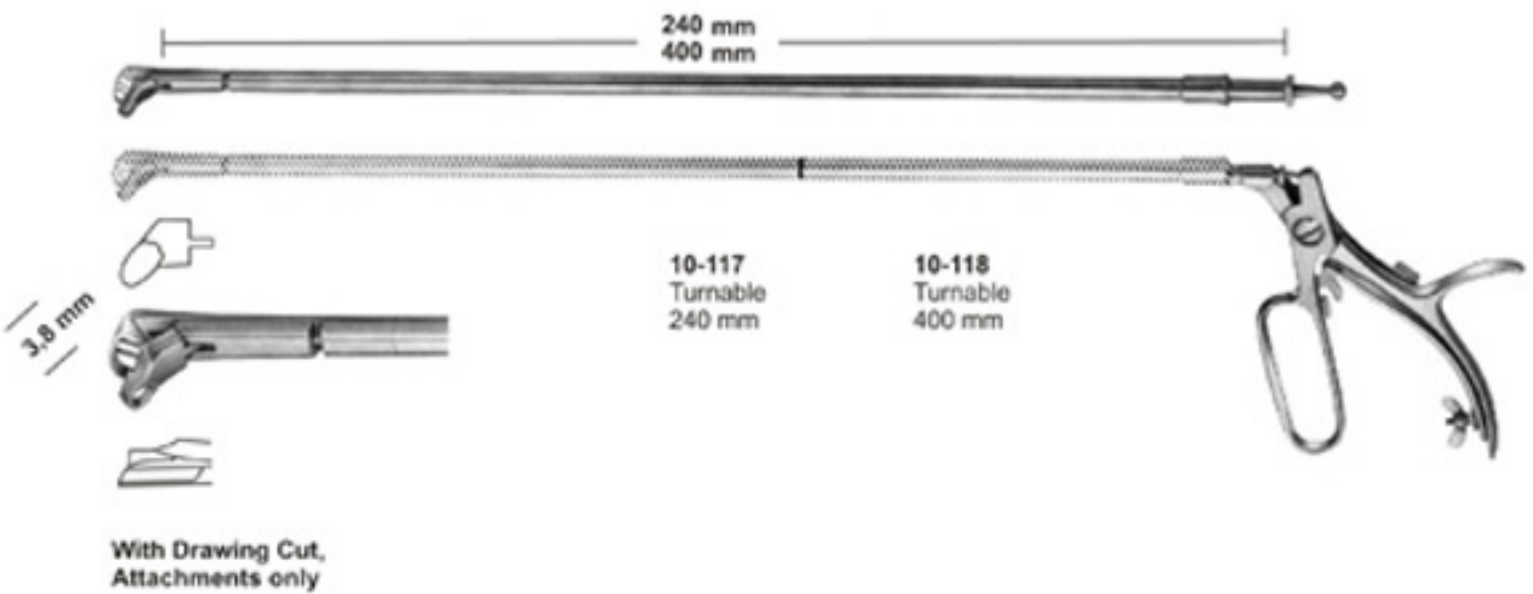
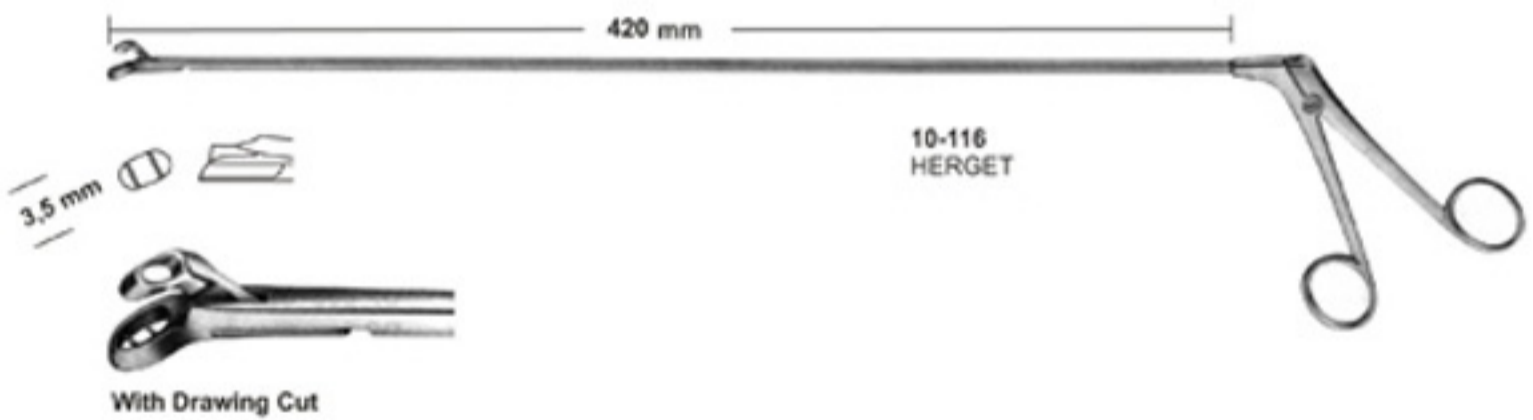
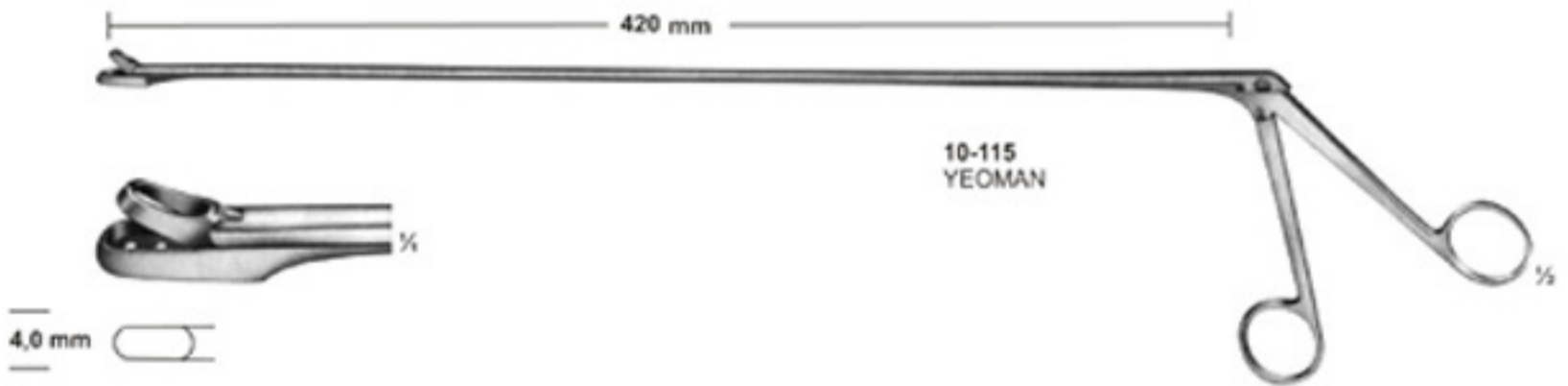
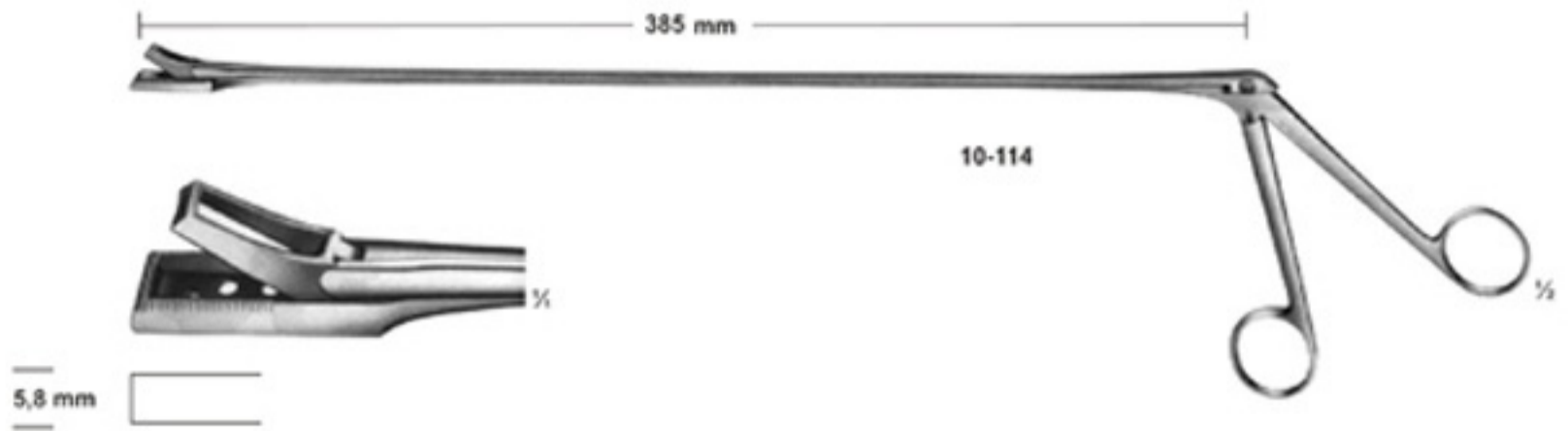

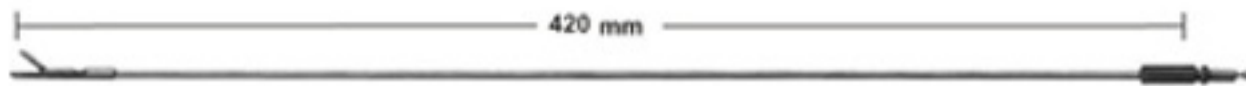

<u>3,5 mm</u>			10-119
<u>3,5 mm</u>			10-120
<u>4,0 mm</u>			10-121
<u>4,0 mm</u>			10-122



10-119 - 122
Handle for 119 - 120 - 121 - 122

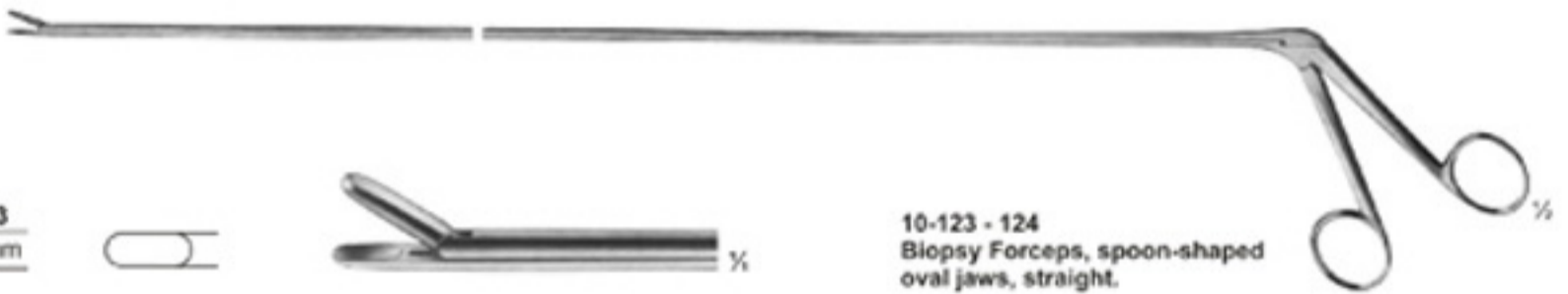

<u>10-123</u> <u>3,5 mm</u>			10-123
<u>10-124</u> <u>4, mm</u>			

10-123 - 124
Biopsy Forceps, spoon-shaped
oval jaws, straight.

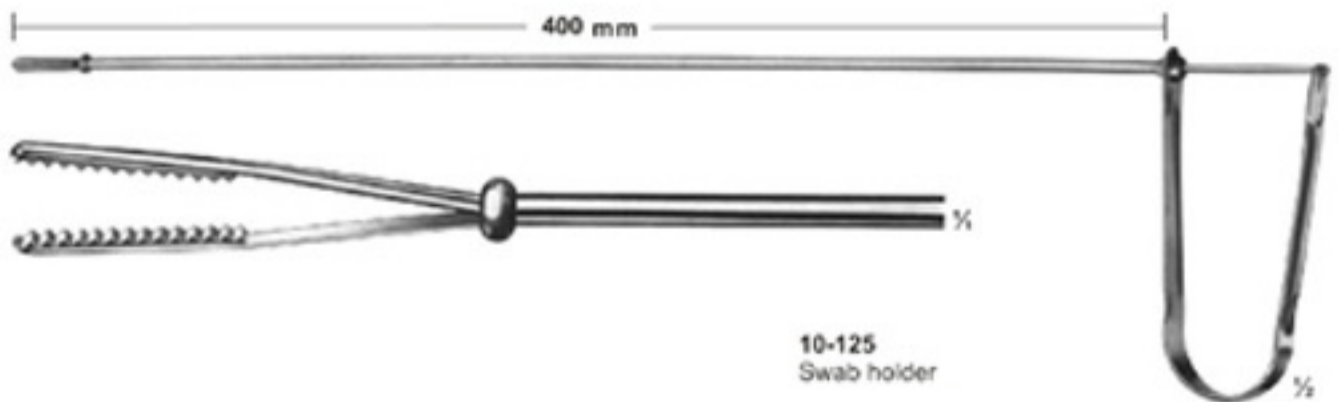

10-125
Swab holder



10-126 - 127
LUER

10-126
220 mm

10-127
245 mm



10-128
HEYWOOD-SMITH
200 mm



10-129
HEYWOOD-SMITH
modif
200 mm

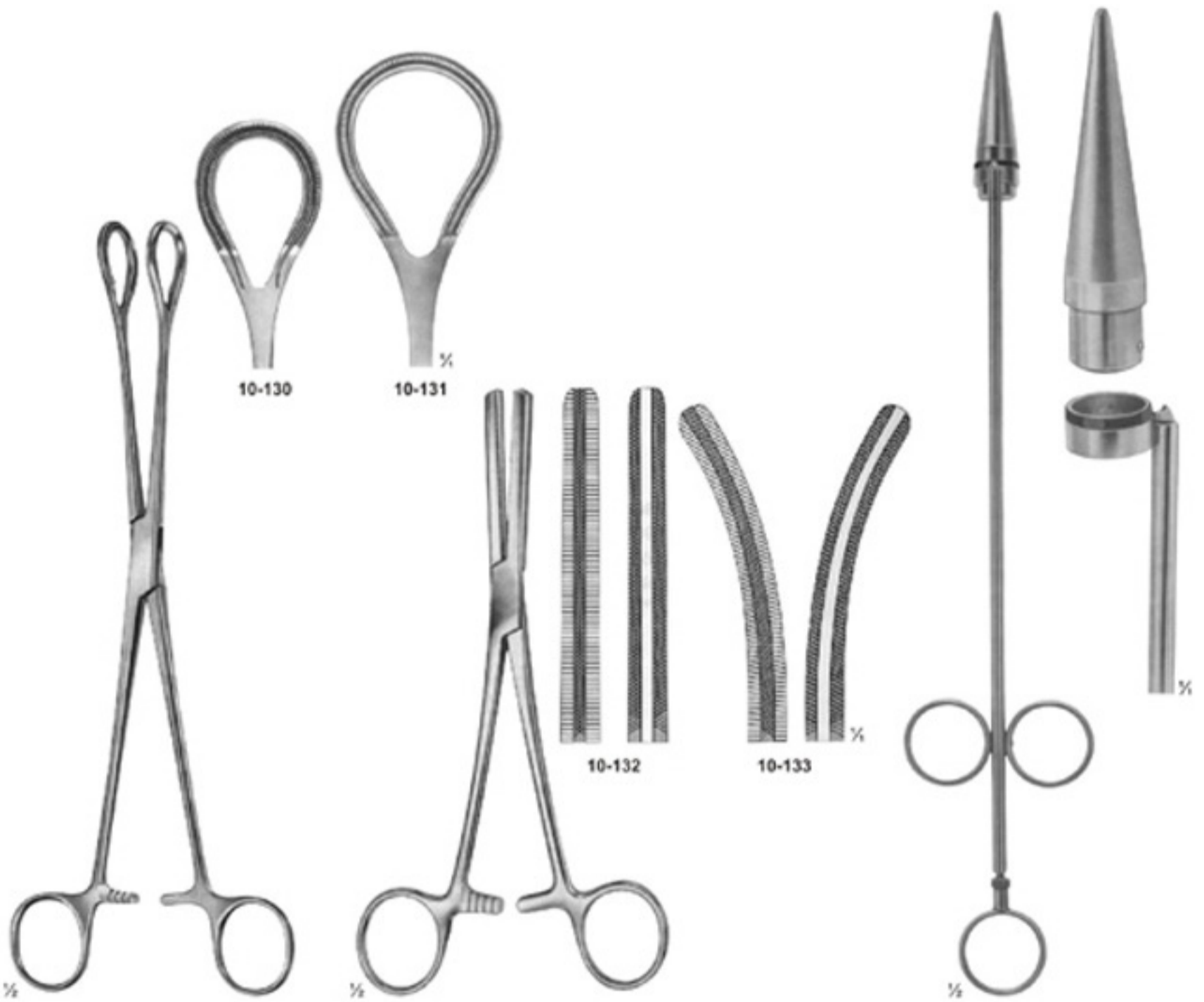

10-130 - 131
250 mm
10-131
270 mm

10-132 - 133
FERGUSSON
200 mm

10-134
RUDD
Haemorrhoidal ligator
with loading
attachment and 100
ligature rubber rings
315 mm



10-135
LOWER
180 mm



10-136
LAHEY (SWEET)
190 mm



10-137
LAHEY
220 mm



10-138
DESJARDINS
Gall duct and cystic forceps
210 mm



10-139
NISSEN
Gall duct and cystic forceps
215 mm

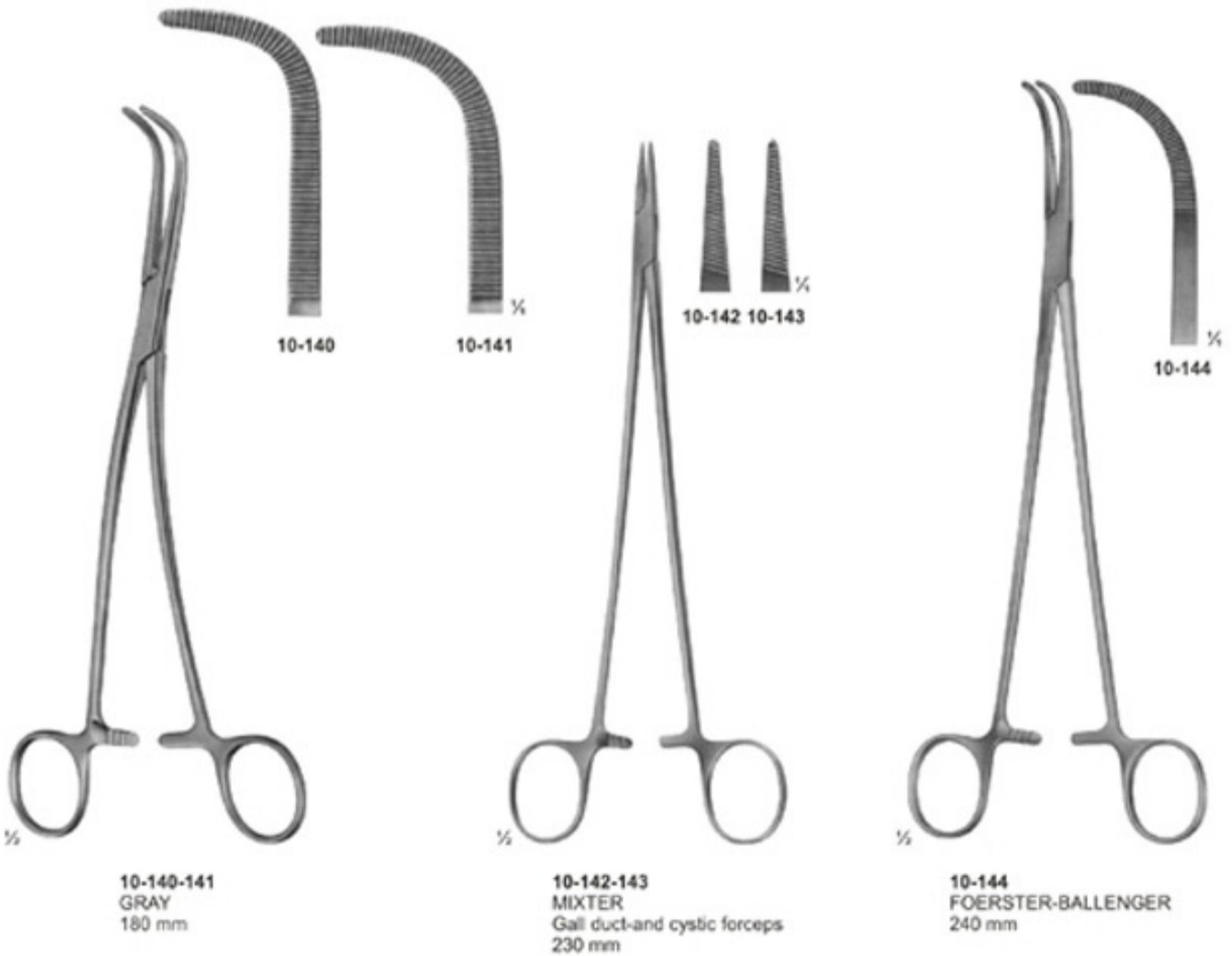

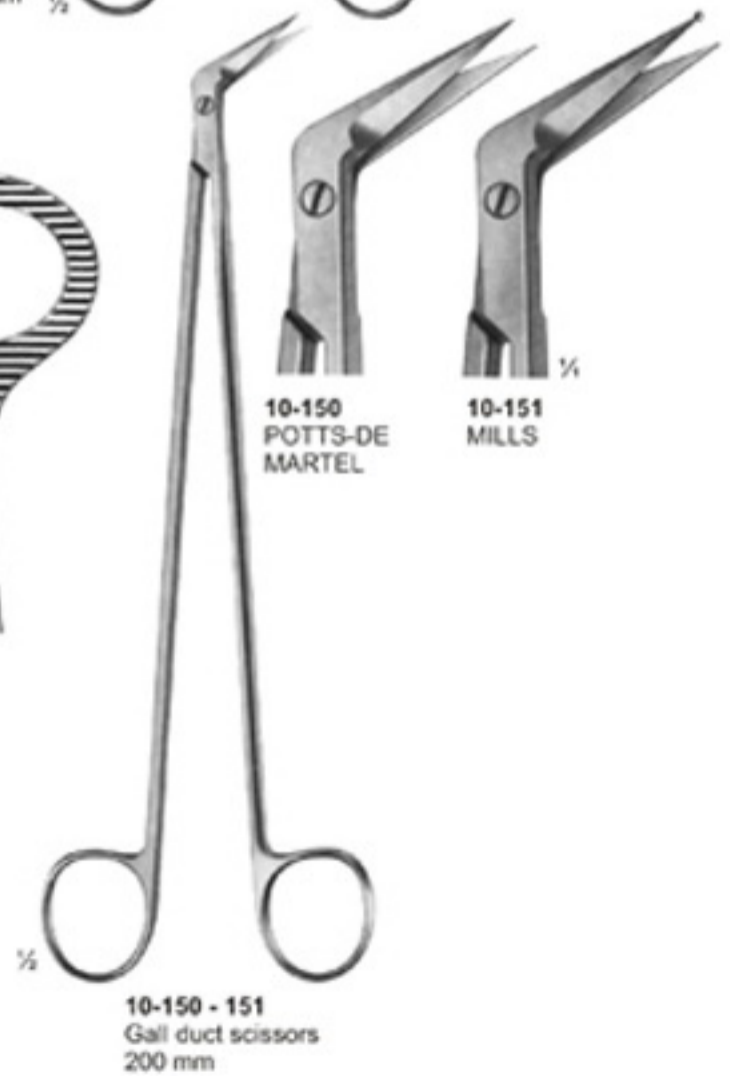
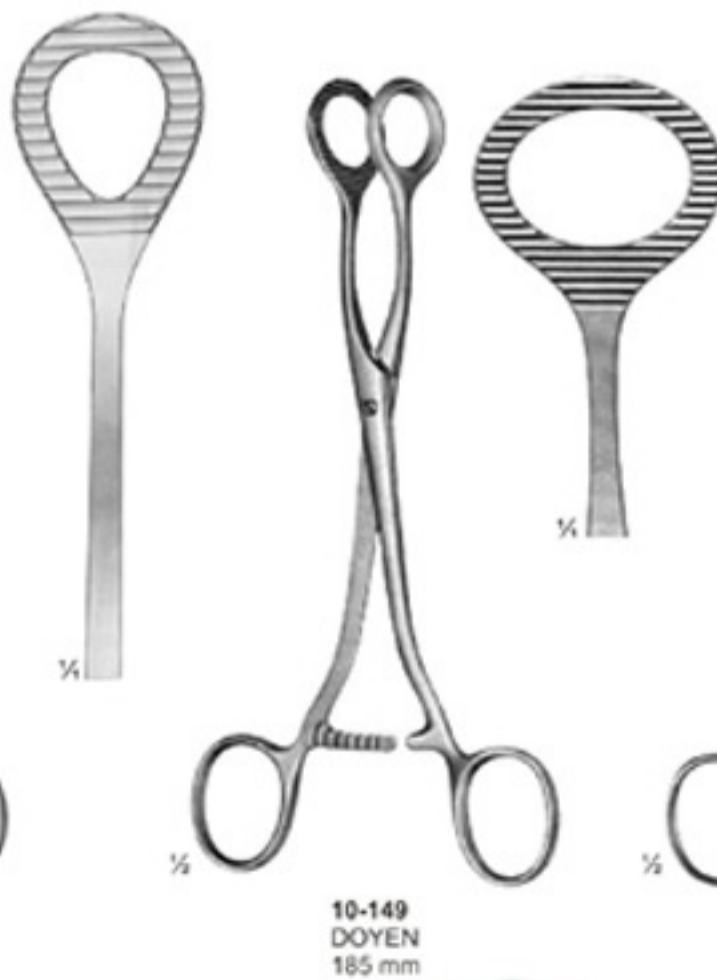
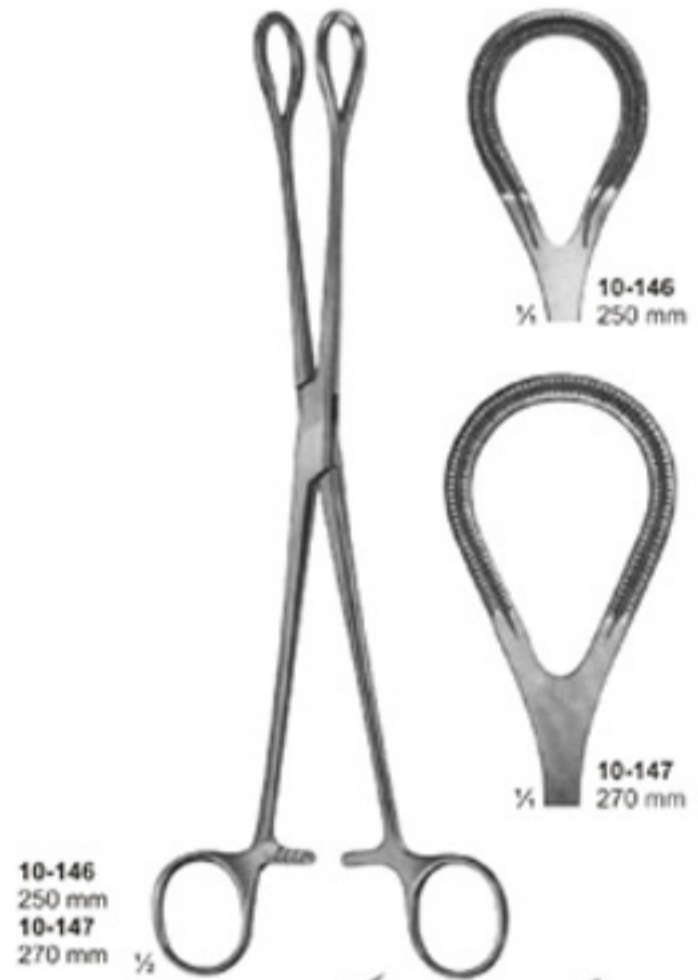
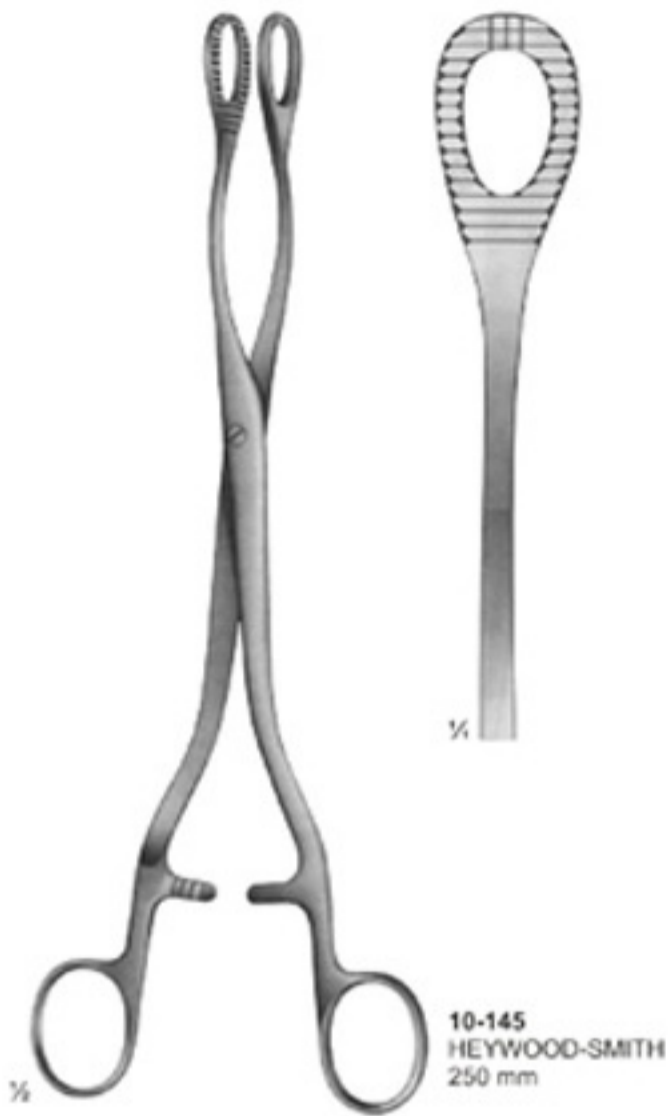

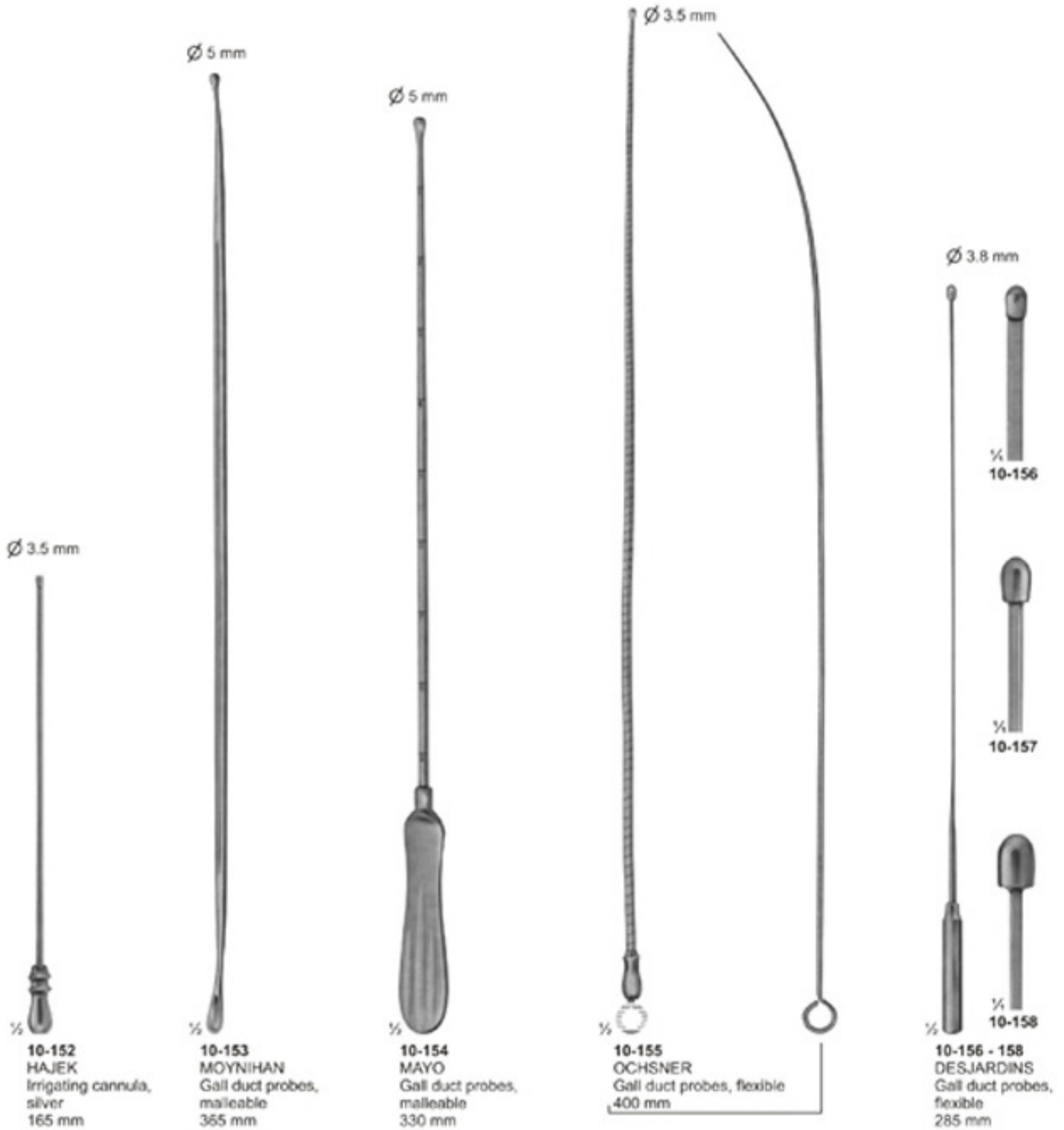

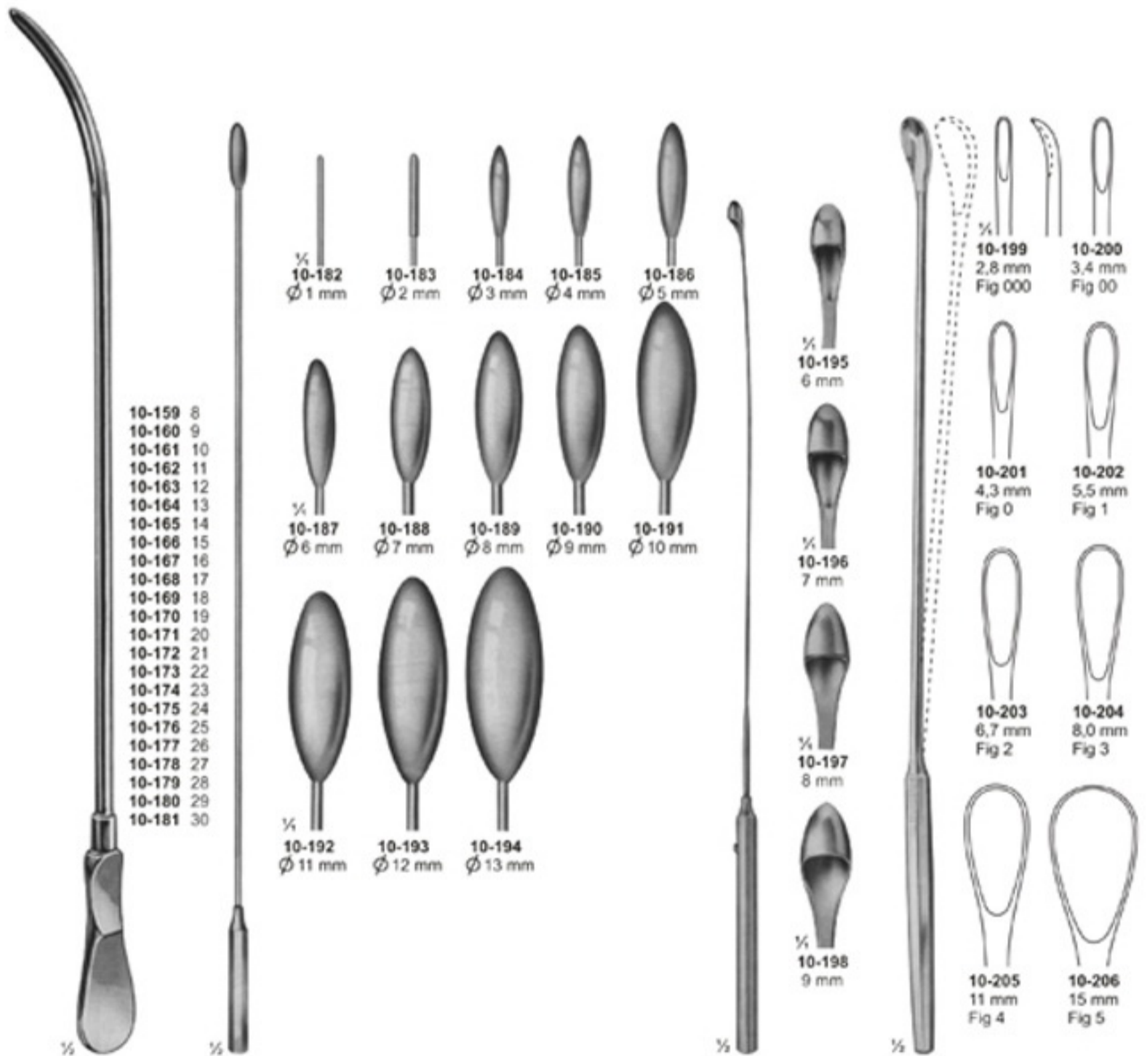

10-159 - 181
DITTEL
Metall bougies and
dilating sounds, stiff
345 mm

10-182 - 194
BAKES
Common bile duct
dilators, malleable
315 mm, 320 mm

10-195 - 198
DESJARDINS
Probes and catch
with flexible shaft
300 mm

10-199 - 206
LUER-KORTE modif
with malleable shaft
310 mm

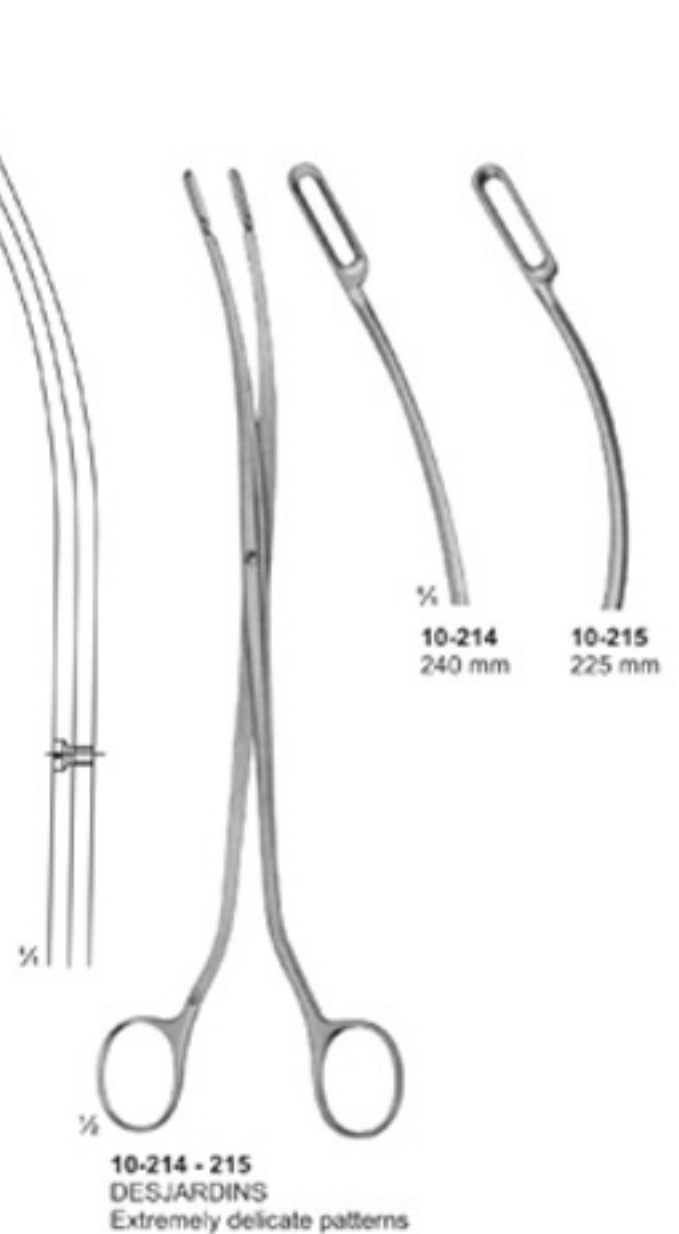

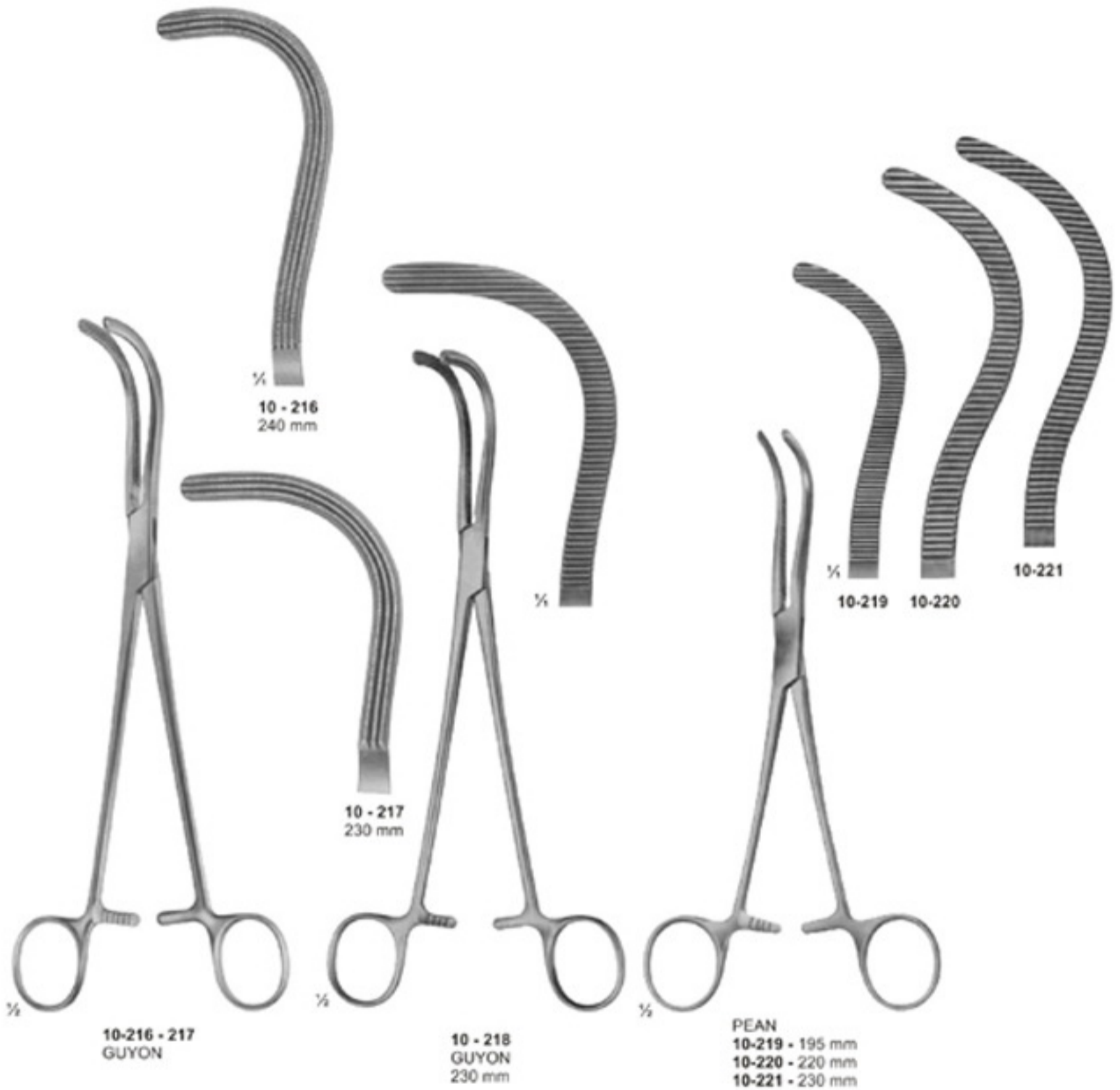



10-222
STILLE
220 mm



10-223
HERRICK
225 mm



10-224
WERTHEIM
225 mm



10-225
COLLIN
285 mm



10-226
DARTIGUES
255 mm



10-227



10-228



10-229



10-229



1/4
10-230



10-231



10-232



1/4
10-233



1/2

10-227 - 230
RANDALL
225 mm



1/2

10-231 - 233
RANDALL
190 mm

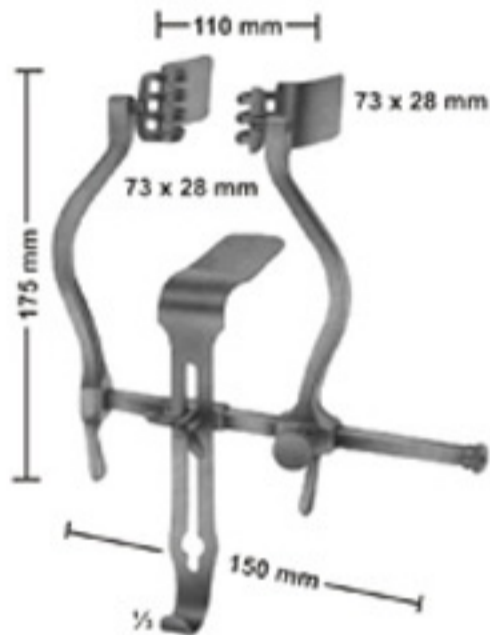

11-101
JUDD-MASSON
Bladder and suprapubic
retractor



11-102
MILLIN
Bladder retractor
105X45 mm



11-103
LEGUEU
Bladder retractor
Center blade
80 x 31 mm

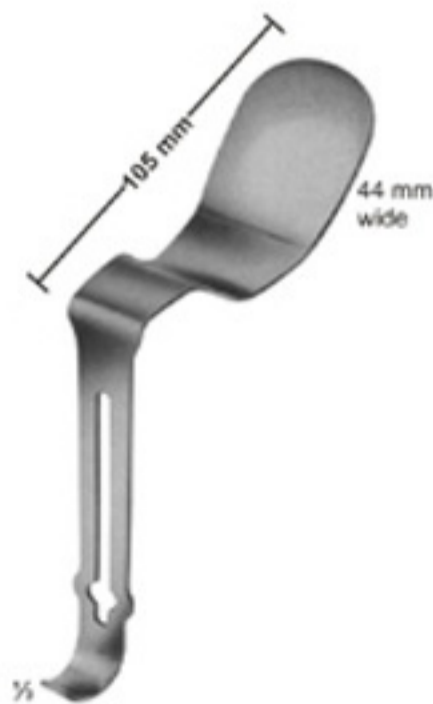

11-104
MILLIN
Center bladder for
retro pubic prostatectomy



11-105
KOCHER
Bladder spatula
235 mm



11-106
MATHIEU
Foreign body forceps
Length of shaft
190 mm

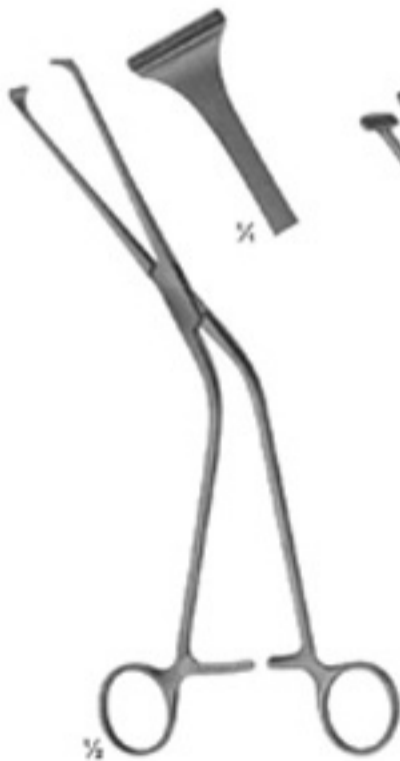

11-107
MILLIN
Lobe grasping
forceps
245 mm



11-108
MILLIN
Lobe grasping
forceps
235 mm



11-109
MILLIN
Bladder neck spreader
285 mm



11-110
Ureter forceps
240 mm



11-111
GUYON
Catheter guide
(introducer)
365 mm

- 11-112 6
- 11-113 7
- 11-114 8
- 11-115 9
- 11-116 10
- 11-117 11
- 11-118 12
- 11-119 13
- 11-120 14
- 11-121 15
- 11-122 16
- 11-123 18
- 11-124 20



11-112 - 124
Female catheters,
metal
160 mm

- 11-125 8
- 11-126 9
- 11-127 10
- 11-128 11
- 11-129 12
- 11-130 13
- 11-131 14
- 11-132 15
- 11-133 16
- 11-134 17
- 11-135 18
- 11-136 19
- 11-137 20
- 11-138 21
- 11-139 22
- 11-140 23
- 11-141 24
- 11-142 25
- 11-143 26
- 11-144 27
- 11-145 28
- 11-146 29
- 11-147 30

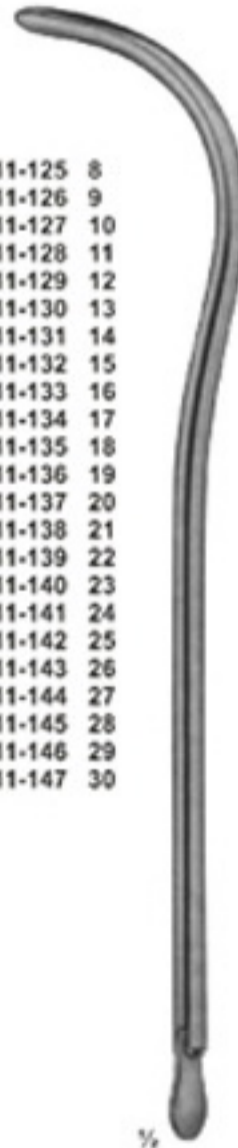

11-125 - 147
Urethral bougies
and dilating sounds
345 mm

- 11-148 Ben. 24/Charr. 12
- 11-149 Ben. 25
- 11-150 Ben. 26/Charr. 13
- 11-151 Ben. 27
- 11-152 Ben. 28/Charr. 14
- 11-153 Ben. 29
- 11-154 Ben. 30/Charr. 15
- 11-155 Ben. 31
- 11-156 Ben. 32/Charr. 16
- 11-157 Ben. 33
- 11-158 Ben. 34/Charr. 17
- 11-159 Ben. 35
- 11-160 Ben. 36/Charr. 18
- 11-161 Ben. 37
- 11-162 Ben. 38/Charr. 19
- 11-163 Ben. 39
- 11-164 Ben. 40/Charr. 20
- 11-165 Ben. 41
- 11-166 Ben. 42/Charr. 21
- 11-167 Ben. 43
- 11-168 Ben. 44/Charr. 22
- 11-169 Ben. 45
- 11-170 Ben. 46/Charr. 23
- 11-171 Ben. 47
- 11-172 Ben. 48/Charr. 24
- 11-173 Ben. 49
- 11-174 Ben. 50/Charr. 25
- 11-175 Ben. 51
- 11-176 Ben. 52/Charr. 26
- 11-177 Ben. 53
- 11-178 Ben. 54/Charr. 27
- 11-179 Ben. 55
- 11-180 Ben. 56/Charr. 28
- 11-181 Ben. 57
- 11-182 Ben. 58/Charr. 29
- 11-183 Ben. 59
- 11-184 Ben. 60/Charr. 30



11-148 - 184
Urethral bougies
and dilating sounds
255 mm



11-185
GUYON
Set of urethral bougies and dilating sounds,
in metal case, with lift out rack and bottom
rack, containing 21 urethral and dilating sounds.



11-186
WINKELMANN
Circumcision Clamps
12 mm / 16 mm / 20 mm



11-187
KLIMA ROSEGGER
35 X 1,8 mm
Sternal puncture needle

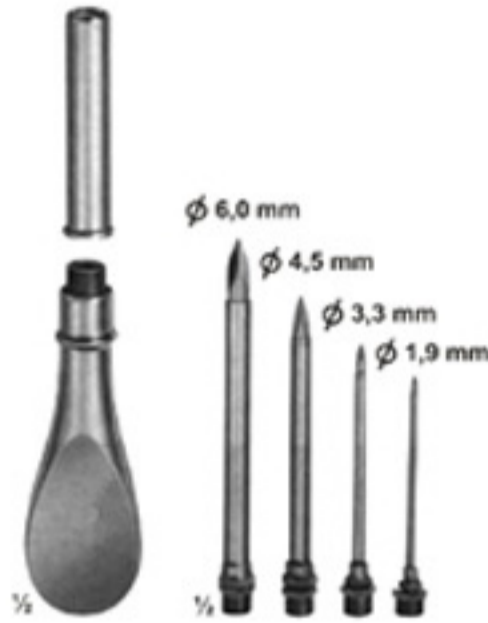

11-188
Universal trocar
with 4 tips



11-189 - 193
Inside dime, Outside dime
11-189 2,2 mm 3,0 mm
11-190 3,0 mm 4,0 mm
11-191 4,0 mm 5,0 mm
11-192 5,0 mm 6,0 mm
11-193 5,5 mm 6,5 mm
for hydrocele and abdominal
puncture



11-194 - 197
Inside dime, Outside dime
11-194 2,2 mm 3,0 mm
11-195 3,0 mm 4,0 mm
11-196 4,0 mm 5,0 mm
11-197 5,0 mm 6,0 mm
for abdominal puncture,
with stop-cock and lateral
drain



11-198 - 199
Inside dime, Outside dime
11-198 6,5 mm 8,0 mm
11-199 9,0 mm 10,0 mm
Empyema trocar



11-200 - 203
Inside dime, Outside dime
11-200 3,0 mm 4,0 mm
11-201 3,6 mm 4,6 mm
11-202 4,3 mm 5,3 mm
11-203 5,0 mm 6,0 mm
Call bladder trocar



11-204
PIERCE
Antrum trocar
4,0 mm



11-205
COAKLEY
Antrum trocar
3,0 mm



12-101
COLLIN
for children
53 x 10 mm

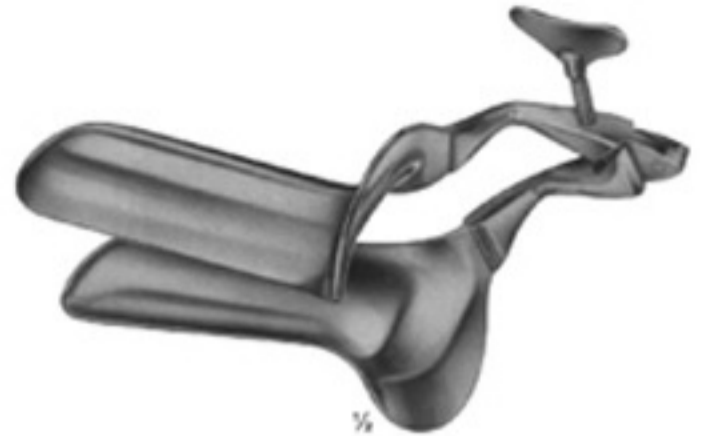

12-102 - 105
COLLIN

12-102	100/90mm	28 mm
12-103	100/90mm	32 mm
12-104	105/95mm	35 mm
12-105	115/105mm	40 mm
Total length/working length		width



12-106
COLLIN
for virgins
95/85 x 18 mm



12-107
CUSCO
for virgins
75 x 17 mm



12-108
CUSCO
for virgins
75 x 17 mm



12-109 - 111
CUSCO

12-109	92X23-25 mm
12-110	100x25-27 mm
12-111	110x27-30 mm



1/2

12-112 - 115
CUSCO
STANDARD
12-112 80X24 mm
12-113 80X32 mm
12-114 90X36 mm
12-115 110X37 mm



1/2

12-116 - 119
CUSCO
12-116 80X24 mm
12-117 80X32 mm
12-118 90X36 mm
12-119 110X37 mm



1/2

12-120 - 122
CUSCO
12-120 80X24 mm
12-121 80X32 mm
12-122 115X36 mm



1/2

12-123 - 124
SEYFFERT
12-123 100X24 mm
12-124 110X32 mm
230 mm



1/2

12-125
SEMM
for children
and virgins
180 mm



12-126 - 128
GRAVE
12-126 75X20 mm
12-127 95X30 mm
12-128 105X33 mm

1/2



12-129 - 130
PEDERSON
12-129 100X22 mm
12-130 120X25 mm

1/2



12-131 - 132
BRIESKY
12-131 72X25 mm / 77X30 mm
12-132 75X30 mm / 92X38 mm
170 mm

1/2



12-133 - 134
BRIESKY
12-133 100X22 mm
77 X30 mm
140 mm
12-134 120X25 mm
92 X38 mm
170 mm

1/2



1/2

12-135 - 137
SEIDL
12-135 80X8 mm
12-136 80X10 mm
12-137 90X14 mm
For children and infants
170 mm



1/2

12-138
KRISTELLER
70X15 mm, (170 mm)
For children



1/2

12-139 - 141
SIMS
12-139 70X26 mm
75 X30 mm 125 mm
12-140 75X30 mm
80 X85 mm 150 mm
11-141 80X36 mm
90 X40 mm 175 mm



12-142 - 146
KRISTELLER
 12-142 110X18 mm
 12-143 110X20 mm
 12-144 110X27 mm
 12-145 110X30 mm
 12-146 110X36 mm
 220 mm

12-147 - 150
KRISTELLER
 Upper blades

12-151 - 154
KRISTELLER
 Lower blades

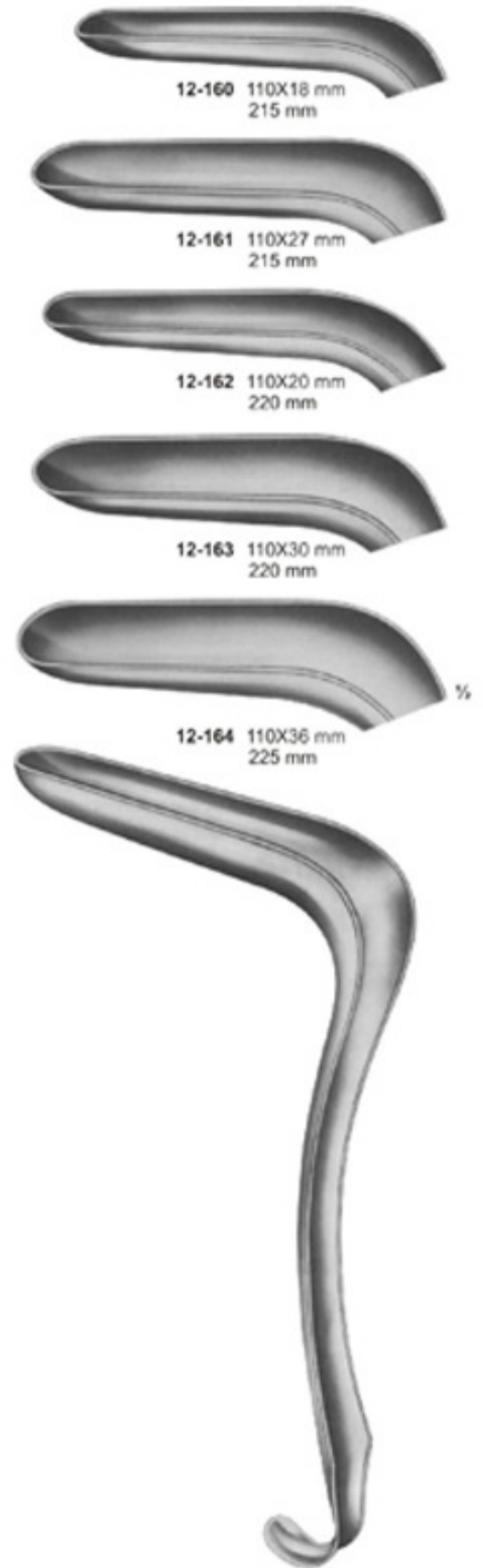

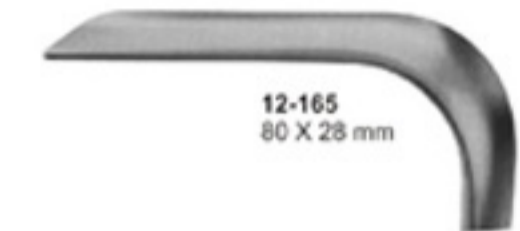

12-165
80 X 28 mm



12-166
85 X 35 mm



12-167
85 X 40 mm



Slightly Concave

1/2

12-165 - 167
KRISTELLER
205 mm



12-168
76 X 38 mm



12-169
89 X 38 mm



12-170
102 X 38 mm



Slightly Concave

1/2

12-168 - 170
JACKSON
175 mm



56 x 13 mm

1/2
12-171
BRAUN
180 mm



60 x 10 mm

1/2
12-172
BRAUN
180 mm



95 x 17 - 30 mm

12-173
MATHIEU
For children
and virgins
210 mm

1/2



95 x 17-26 mm

12-174
MATHIEU
for children
and virgins fitting
210 mm

1/2



12-175
Handle with cold light
carrier for upper blades
280 mm

1/2

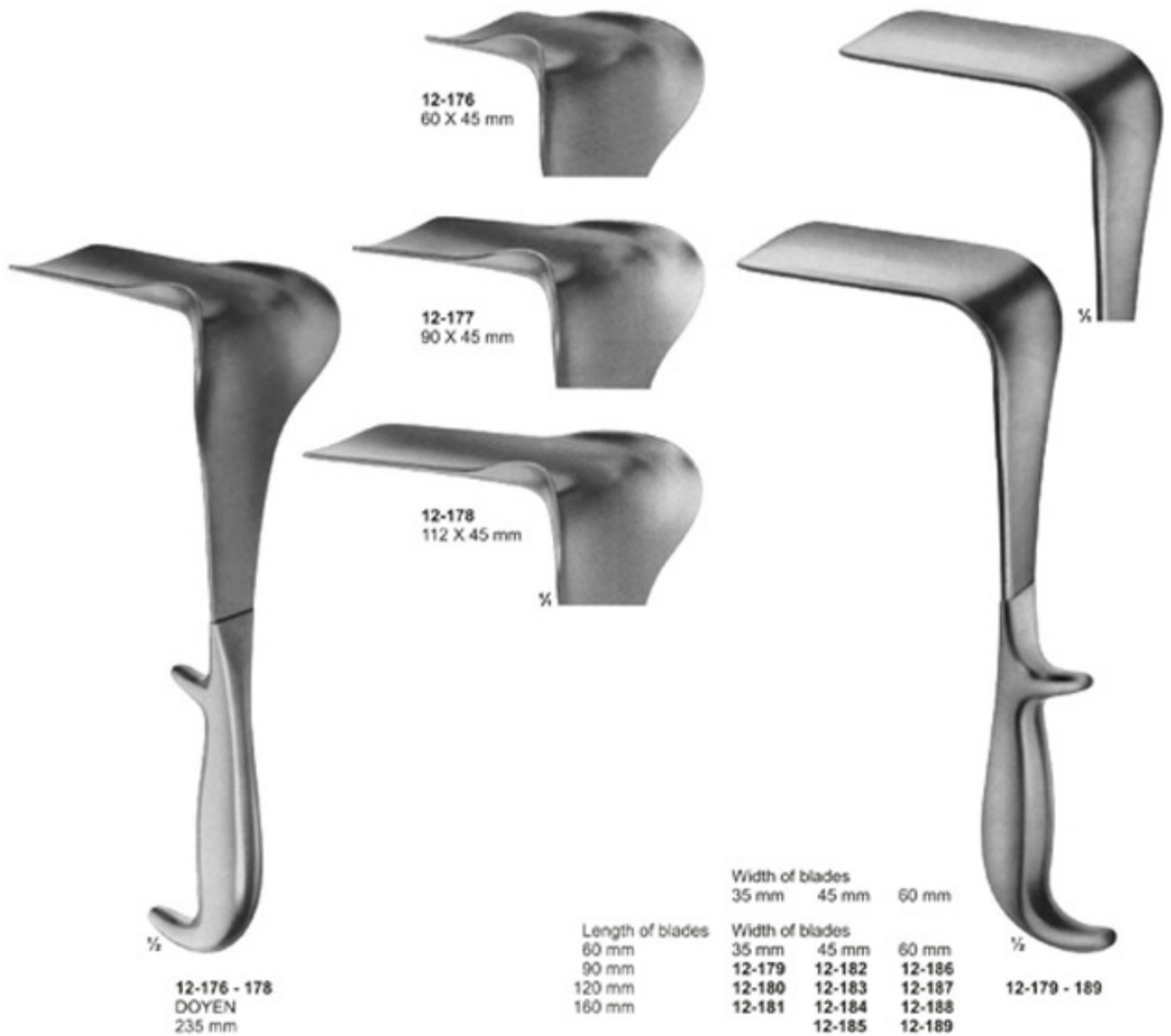



12-190 - 194
BREISKY
WIENER MODELL/
VIENNA PATTERN
12-190 100 X 20 mm
12-191 100 X 25 mm
12-192 100 X 30 mm
12-193 100 X 35 mm
12-194 100 X 40 mm
300 mm



12-195 - 199
BREISKY
WIENER MODELL/
VIENNA PATTERN
12-195 130 X 20 mm
12-196 130 X 25 mm
12-197 130 X 30 mm
12-198 130 X 35 mm
12-199 130 X 40 mm
320 mm



12-200 - 201
WEISSBARTH
12-200 80 X 28 mm
12-201 85 X 42 mm
210 mm



12-202
DOYEN
lateral speculum
80 x 30 mm
250 mm



**12-203
SIMON**
115 X 22 mm
275 mm



**12-204
AUVARD**
65 X 38 mm - 28 mm
1,530 kg
with fixed weight
230 mm



**12-205 - 206
AUVARD**
12-205 75 X 42 mm
(40 mm)
12-206 105 X 43 mm
(40 mm)
with detachable wight
230 mm



**12-207
MARTIN**
with hook shaped
handle for hanging
in weights
270 mm

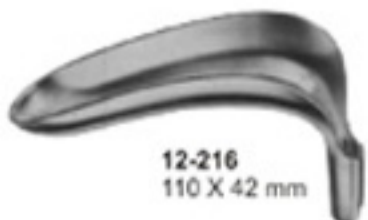
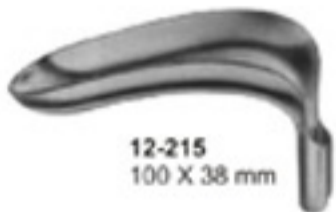

12-213 - 220
SCHERBACK
Set consisting of:
2 handle
8 blades





12-221
JOLL (FRIEDMAN)
155 mm



12-222
RICHTER
170 mm



12-223
GELPI
135 mm



12-224
GELPI
175 mm



¼

13-101 - 143
HEGAR
with very conical point
185 mm

13-101	1	mm	13-123	23	mm
13-102	2	mm	13-124	24	mm
13-103	3	mm	13-125	25	mm
13-104	4	mm	13-126	26	mm
13-105	5	mm	13-127	1	½mm
13-106	6	mm	13-128	2	½mm
13-107	7	mm	13-129	3	½mm
13-108	8	mm	13-130	4	½mm
13-109	9	mm	13-131	5	½mm
13-110	10	mm	13-132	6	½mm
13-111	11	mm	13-133	7	½mm
13-112	12	mm	13-134	8	½mm
13-113	13	mm	13-135	9	½mm
13-114	14	mm	13-136	10	½mm
13-115	15	mm	13-137	11	½mm
13-116	16	mm	13-138	12	½mm
13-117	17	mm	13-139	13	½mm
13-118	18	mm	13-140	14	½mm
13-119	19	mm	13-141	15	½mm
13-120	20	mm	13-142	16	½mm
13-121	21	mm	13-143	17	½mm
13-122	22	mm			



¼

13-144 - 152
HEGAR
205 mm

13-144	1+2	mm
13-145	3+4	mm
13-146	5+6	mm
13-147	7+8	mm
13-148	9+10	mm
13-149	11+12	mm
13-150	13+14	mm
13-151	15+16	mm
13-152	17+18	mm

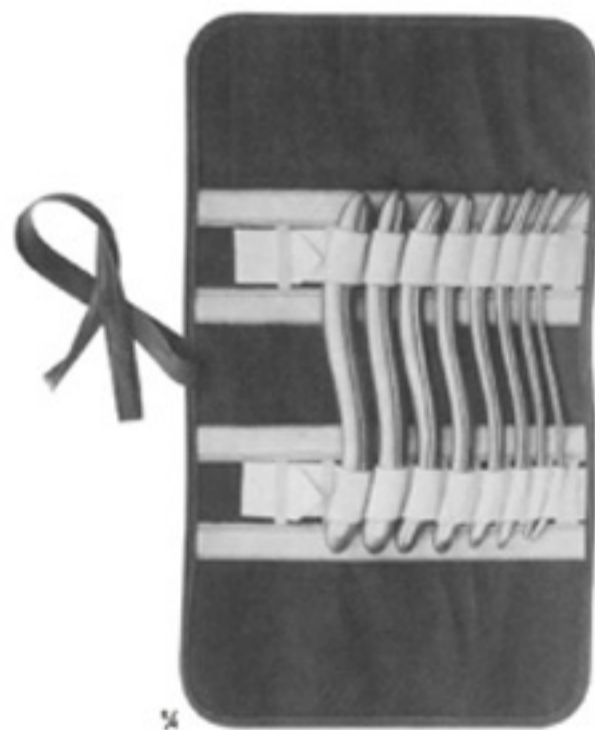

¼

13-153
HEGAR
Uterine dilator set, in canvas
roll with 8 dilators.



13-154
HEGAR
 Dilator set consisting of:
 14 Dilators,
 1 Rack for dilators (4 - 12 mm)
 1 Rack for Dilators (13 - 17 mm)
 1 Metal case only,
 with hinged lid, stainless 200 X 100 X 35 mm

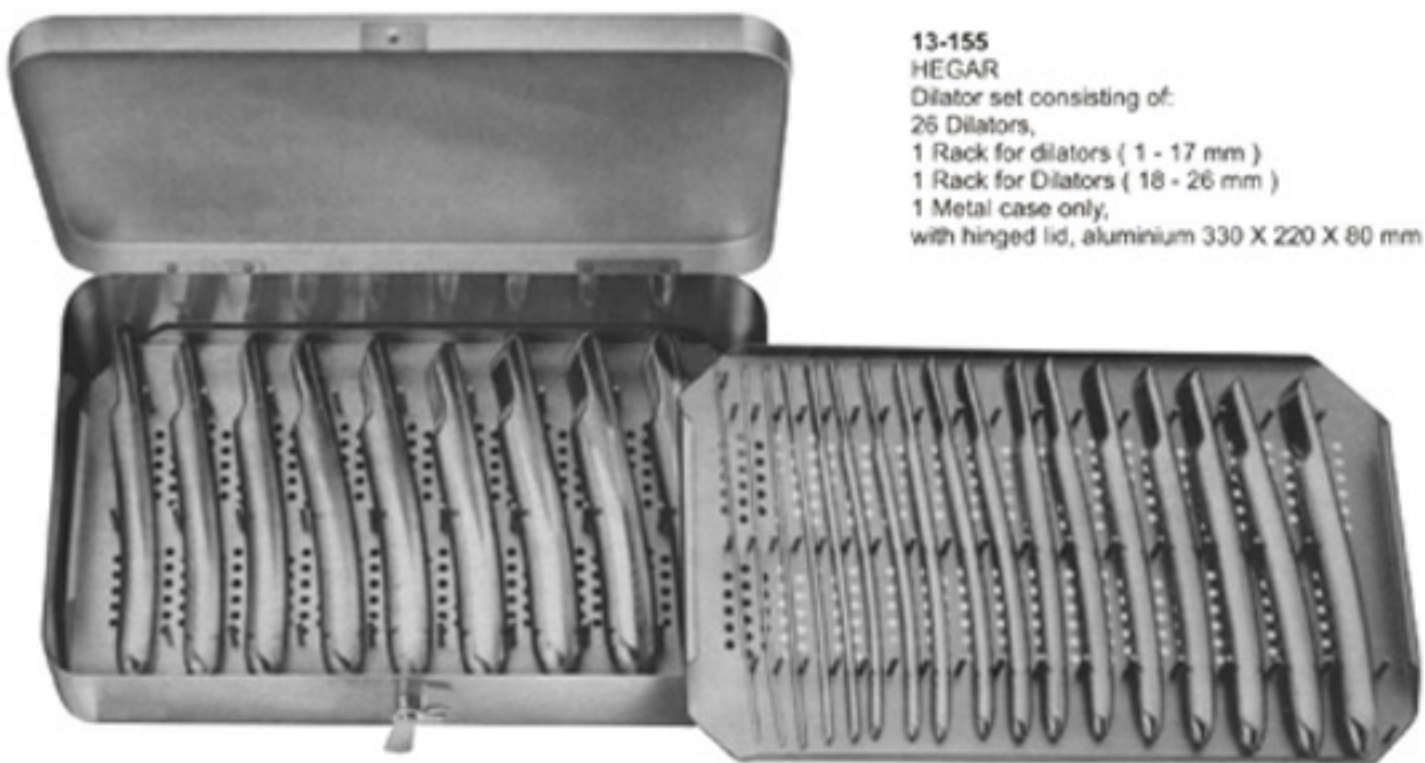

13-155
HEGAR
 Dilator set consisting of:
 26 Dilators,
 1 Rack for dilators (1 - 17 mm)
 1 Rack for Dilators (18 - 26 mm)
 1 Metal case only,
 with hinged lid, aluminium 330 X 220 X 60 mm



13-156
KOGAN
Endospecula for cervix
and urethra, without ratchet
240 mm



13-157
KOGAN
Endospecula for cervix
and urethra, with
scale-ratchet and fixing screws
240 mm



14-101
MAYO
biegsam malleable
330 mm



14-102
SIMS
biegsam malleable
330 mm



14-103
MARTIN
330 mm



14-104
SIMPSON
malleable
silver-plated
290 mm



14-105
BRAUN
Uterine
depressor
270 mm



14-106
Cotton
applicator
270 mm

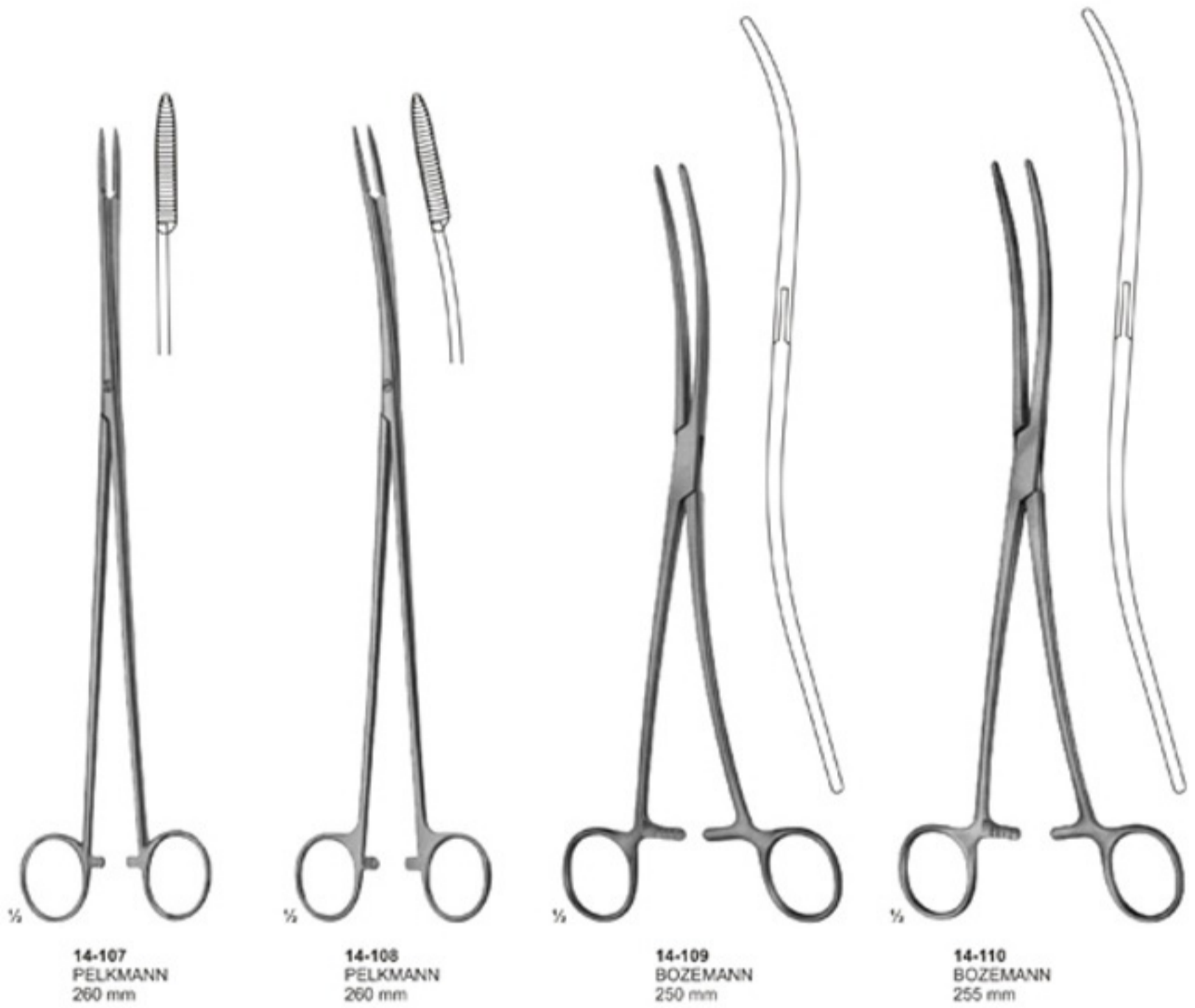

Jaws with longitudinal groove

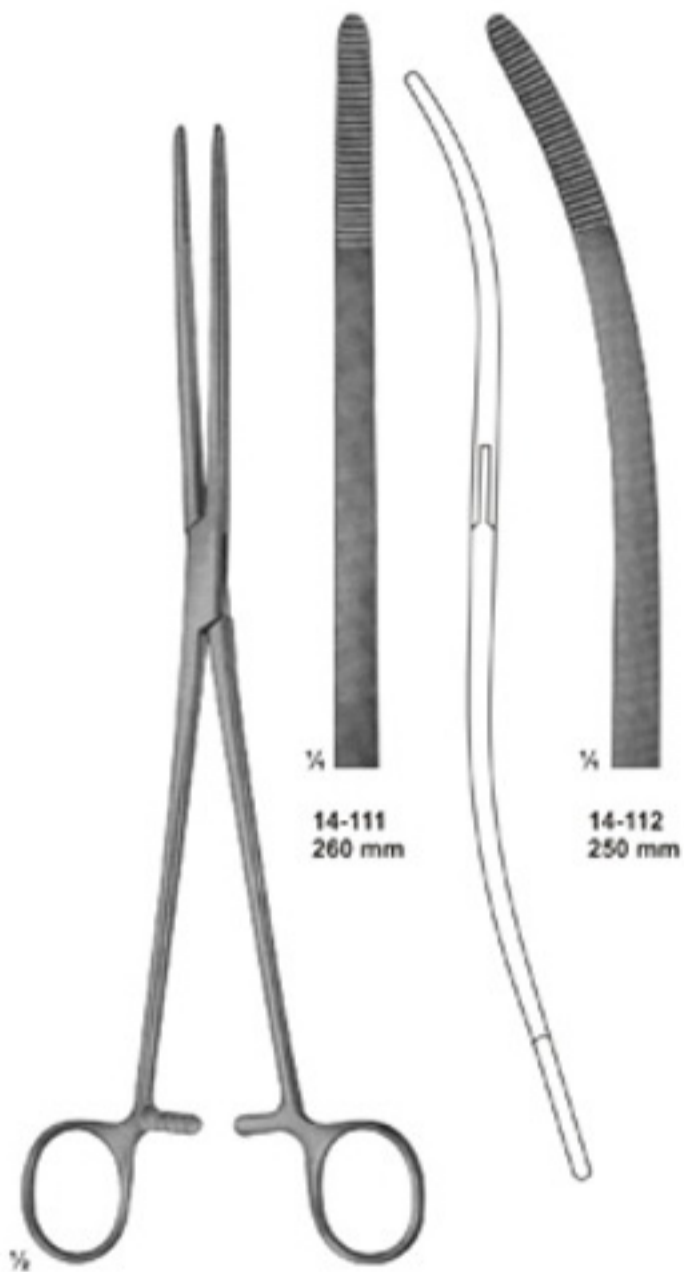

14-111 - 112
BOZEMANN



14-113
BOZEMANN-DOUGLAS
260 mm



14-114
BRAUN
slender type
250 mm



14-115
SCHRODER
250 mm



14-116
POZZI
heavy type
255 mm



14-117
265 mm



14-118
DUPLAY
250 mm

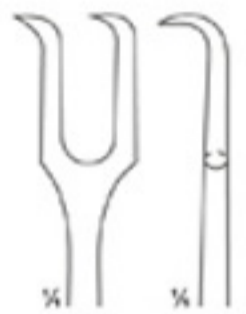

14-119
LAHEY
155 mm

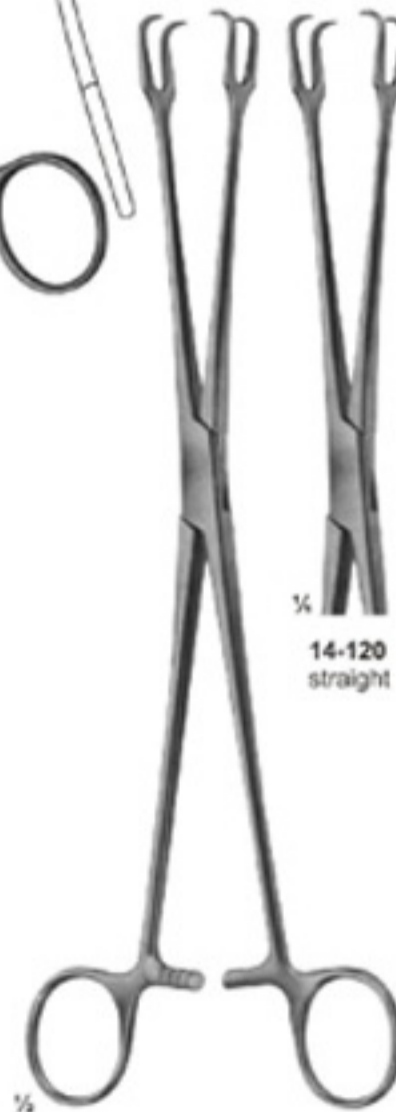

14-120 - 122
SCHRODER
250 mm



14-120
straight



14-121
curved
on flat



14-122
curved
sideways

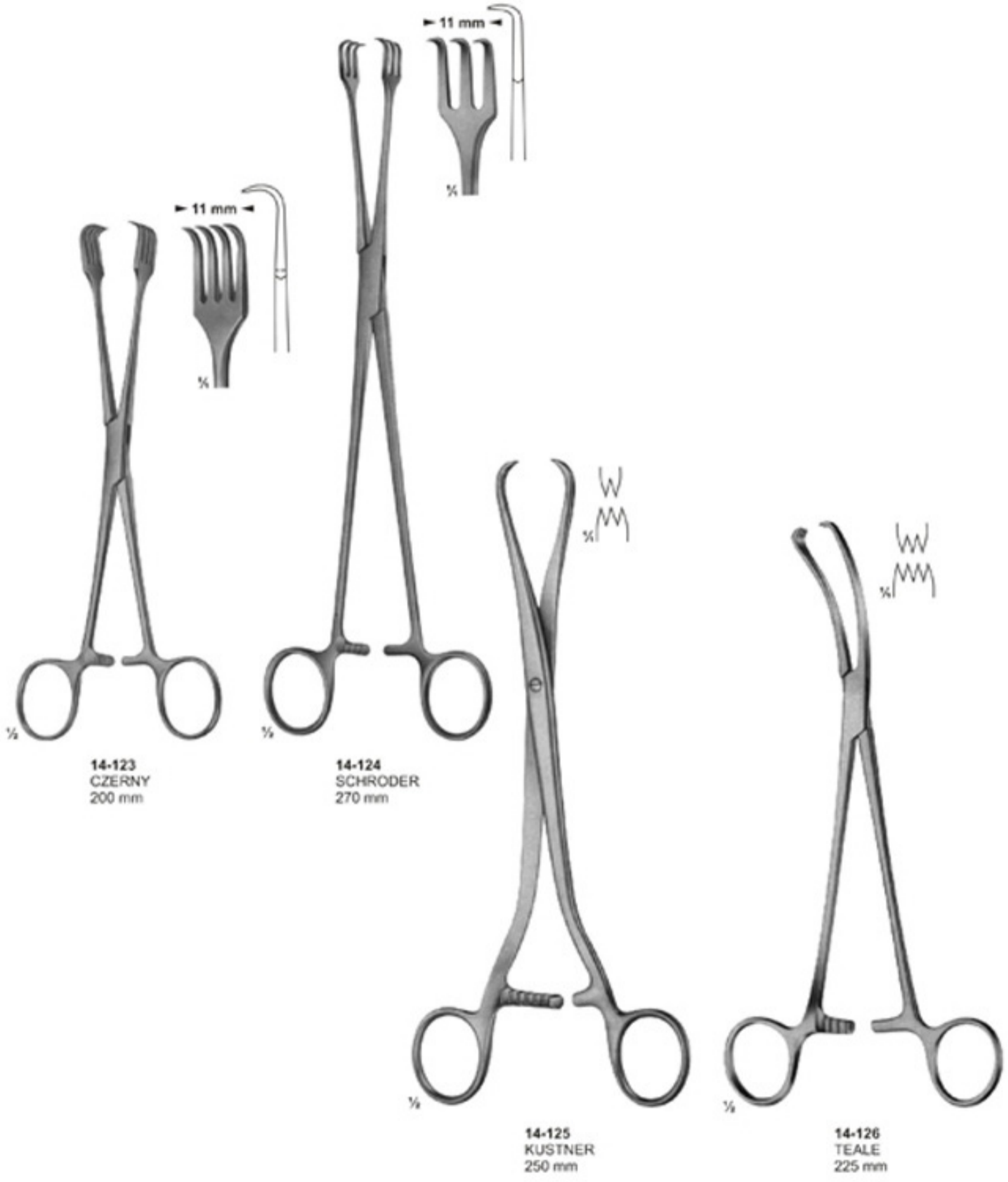

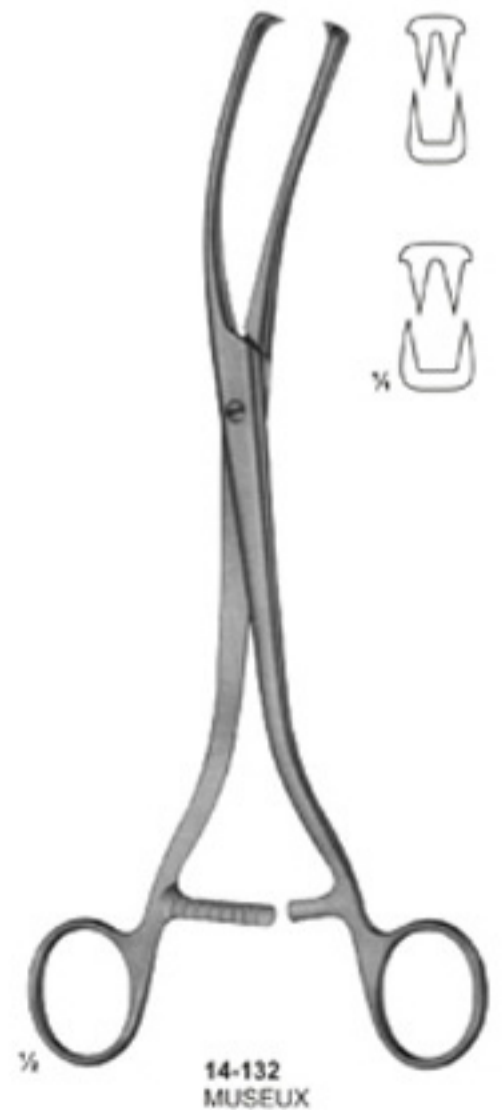
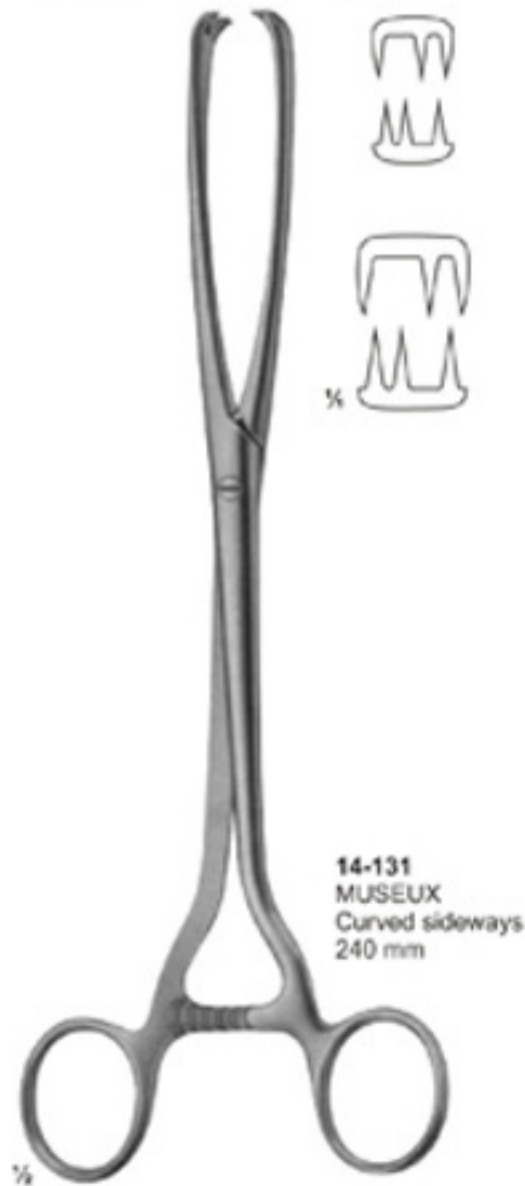
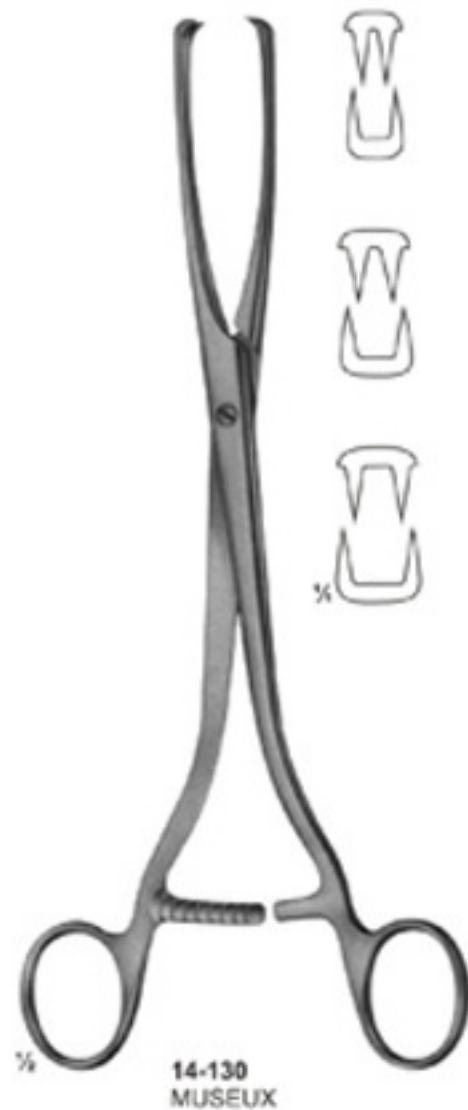

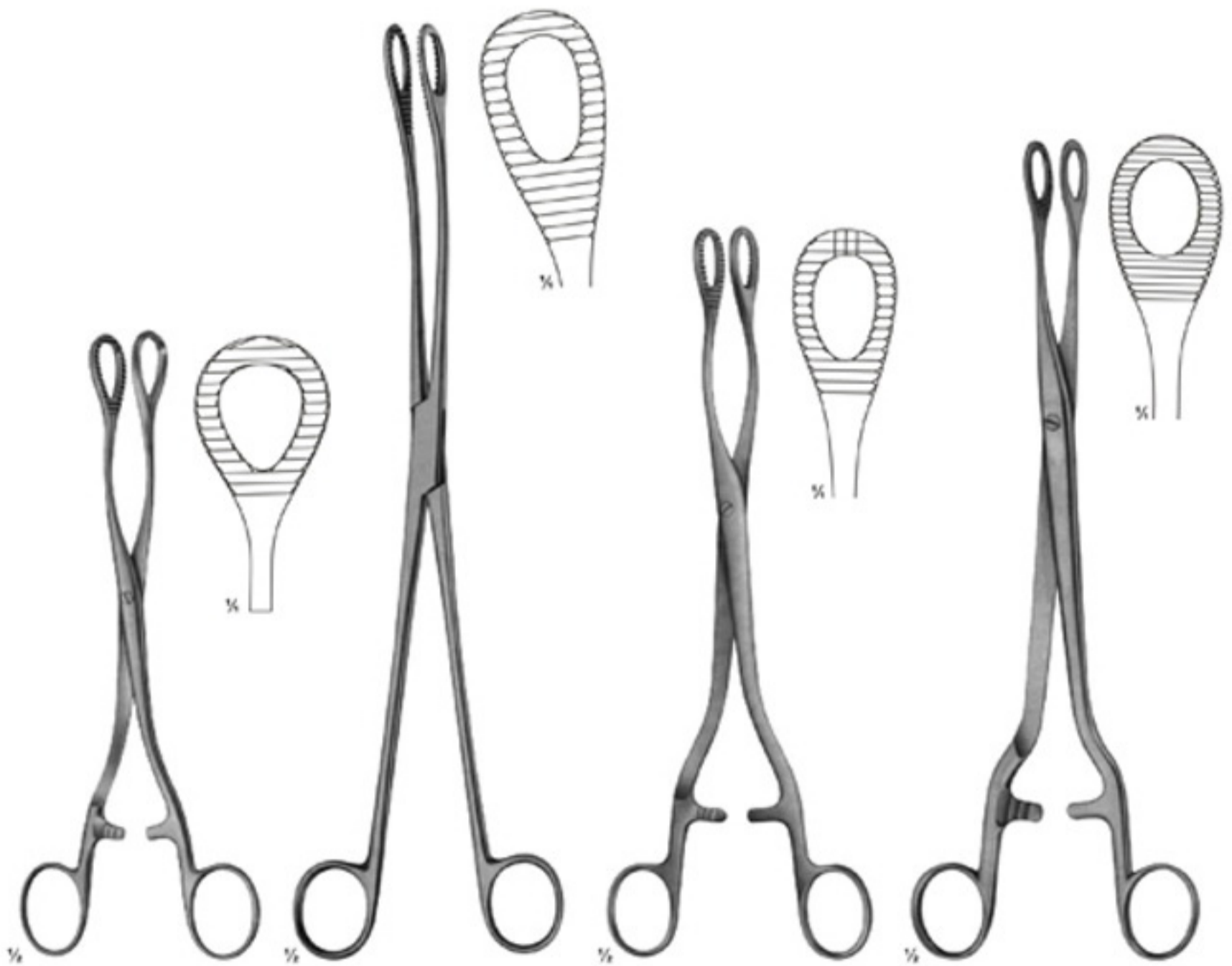

14-133
HEYWOOD-SMITH
200 mm

14-134
KELLY
320 mm

14-135
HEYWOOD-SMITH
250 mm

14-136
NOTO
280 mm



½



½

14-138



½

14-139



½



½

14-137
DOYEN
185 mm



½

14-138 - 139
250 mm 270 mm



½

14-140
BUMM
280 mm

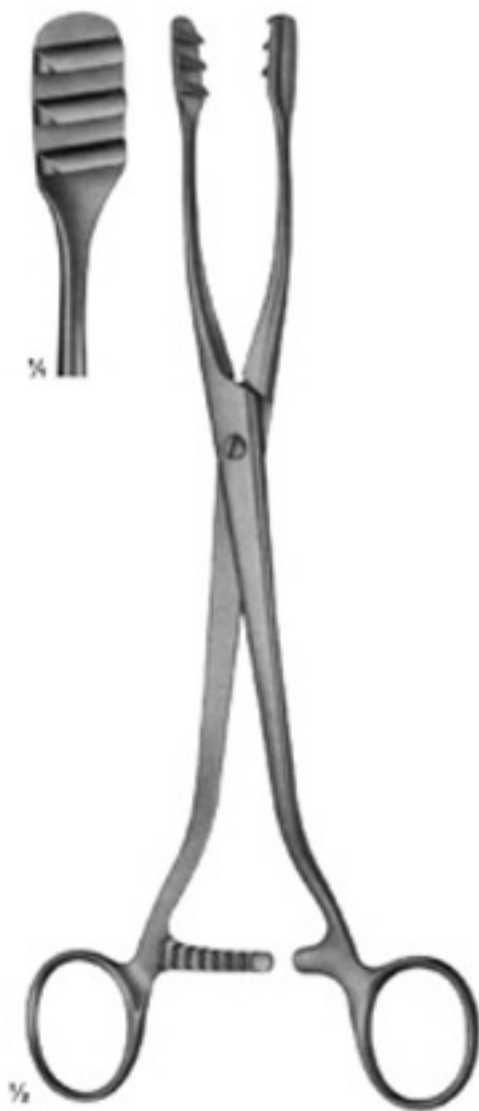

14-141
COLLIN
250 mm



14-142
COLLIN
285 mm



14-143
DARTIGUES
255 mm



14-144
SOMER
235 mm



14-145
STRASSMANN
260 mm

With movable jaws



14-146
COLLIN
265 mm

With movable jaws



14-147
260 mm



14-148
SEGOND
Myomatome
270 mm



14-149
DOYEN
Myoma screw
150 mm



14-150
DOYEN
Myoma screw
190 mm

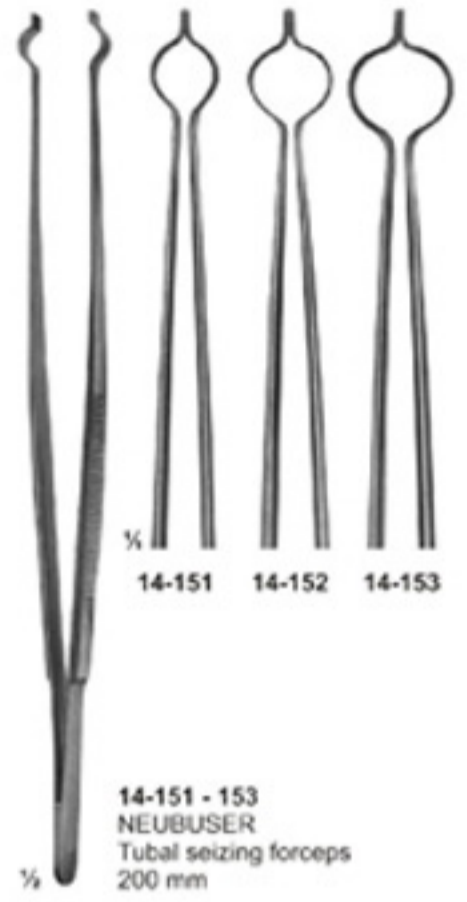

14-151 - 153
NEUBUSER
Tubal seizing forceps
200 mm



14-154
Splint guide
with thread



14-155
Splint guide with
round handle
180 mm



14-156
Angled glass rods
Set . 3 pieces

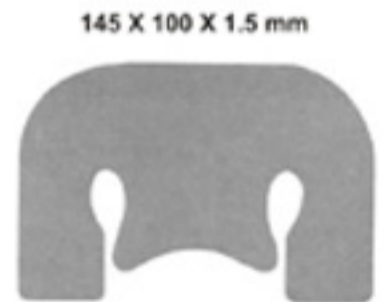

14-157
Silicon operating pad
pre-cut



14-158
Polyacethylen splint material
soft-sterile
0.45 mm

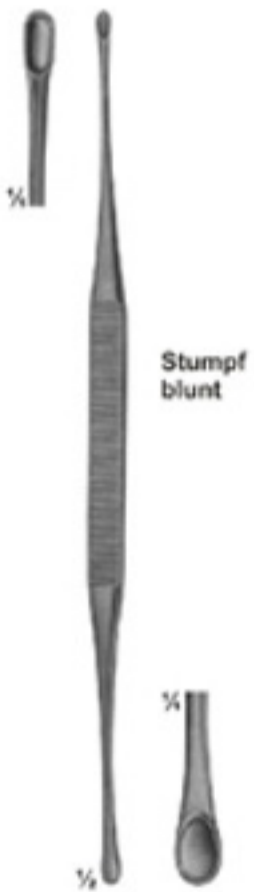

15-101
ASCH
Uterine
Secretion scoop
200 mm

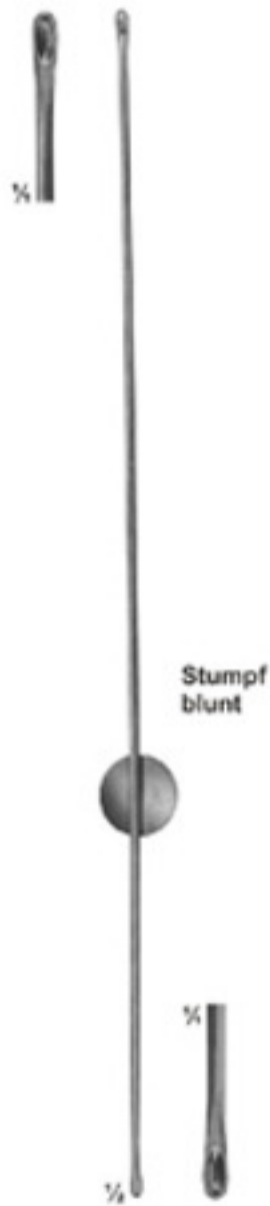

15-102
Uterine
Secretion scoop
270 mm



15-103
NOVAK-SCHOECKAERT
Endometrial biopsy
curette
240 mm



15-104
RANDALL
Endometrial biopsy
curette
240 mm



15-105
THOMS-GAYLOR
240 mm



15-106
SCHUBERT
260 mm



15-107
FAURE
210 mm

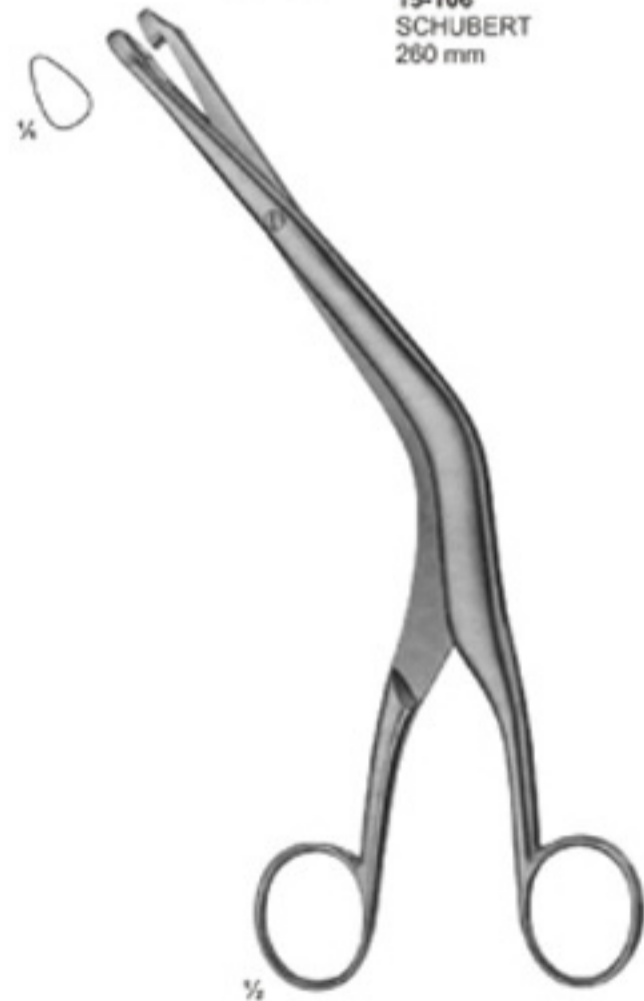

15-108
FAURE
240 mm

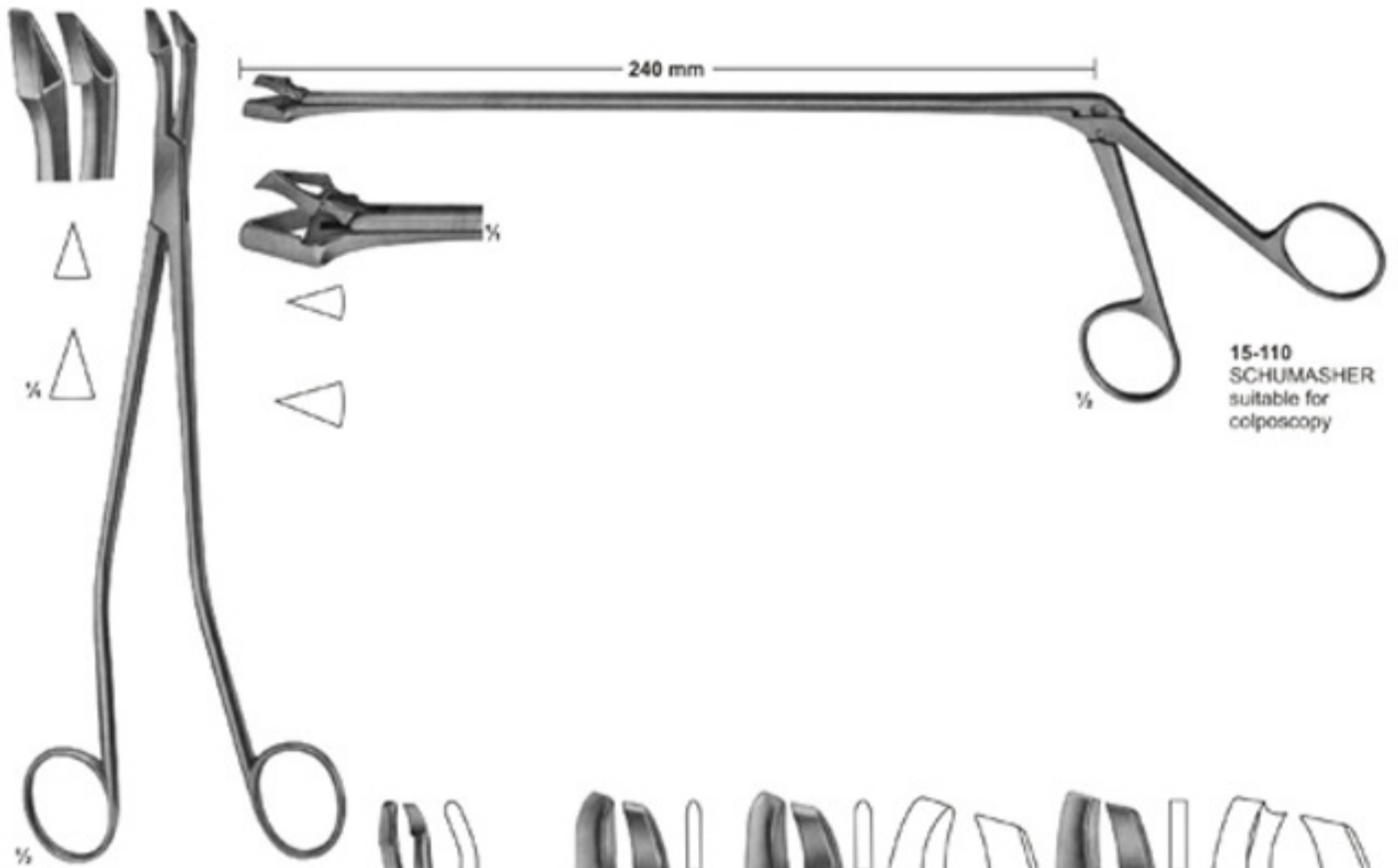

15-110
SCHUMASHER
suitable for
colposcopy

15-109
SCHUMASHER
240mm

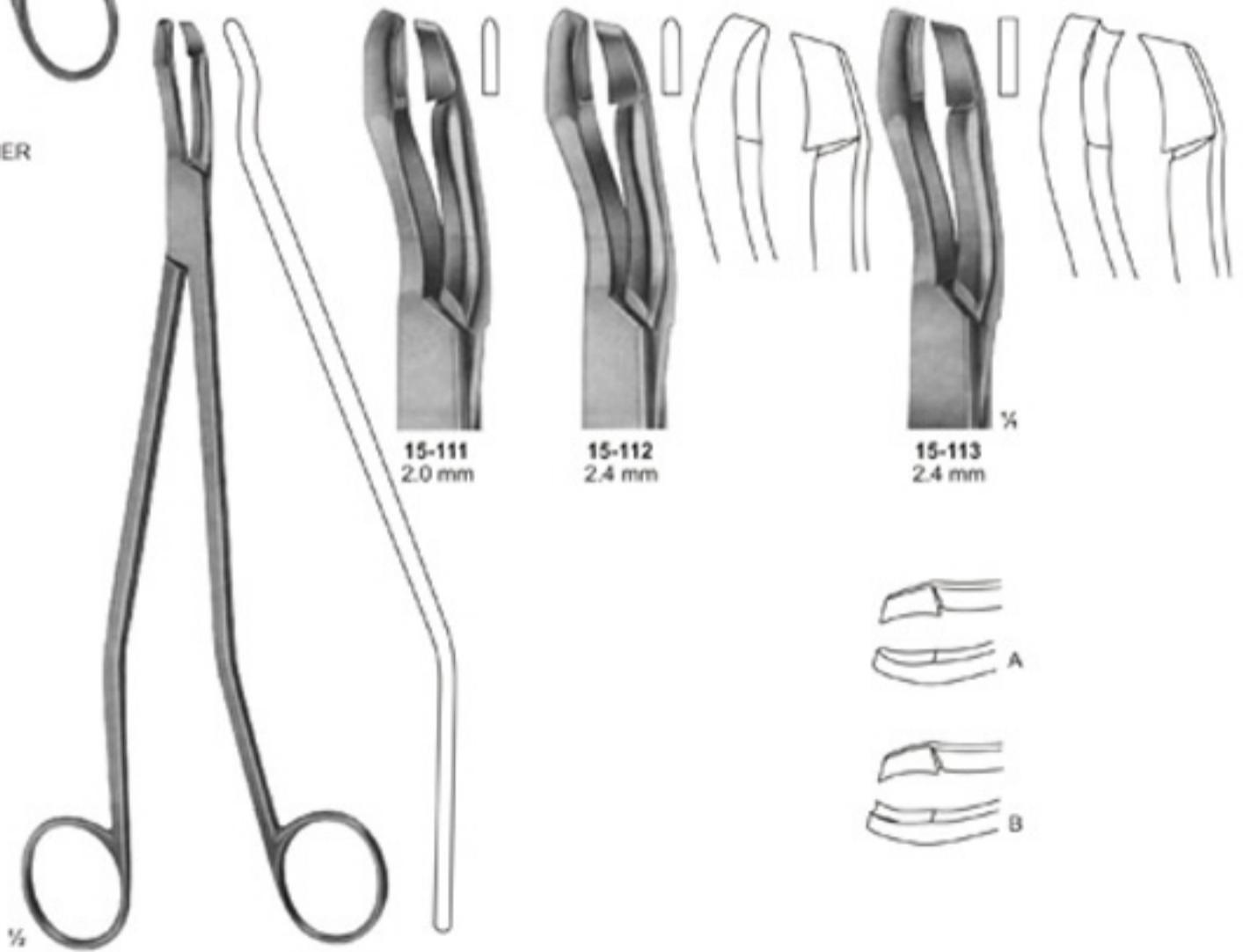

15-111 - 113
SEIDL DBP
Biopsy forceps, bayonet shaped
for portio, vagina and vulva

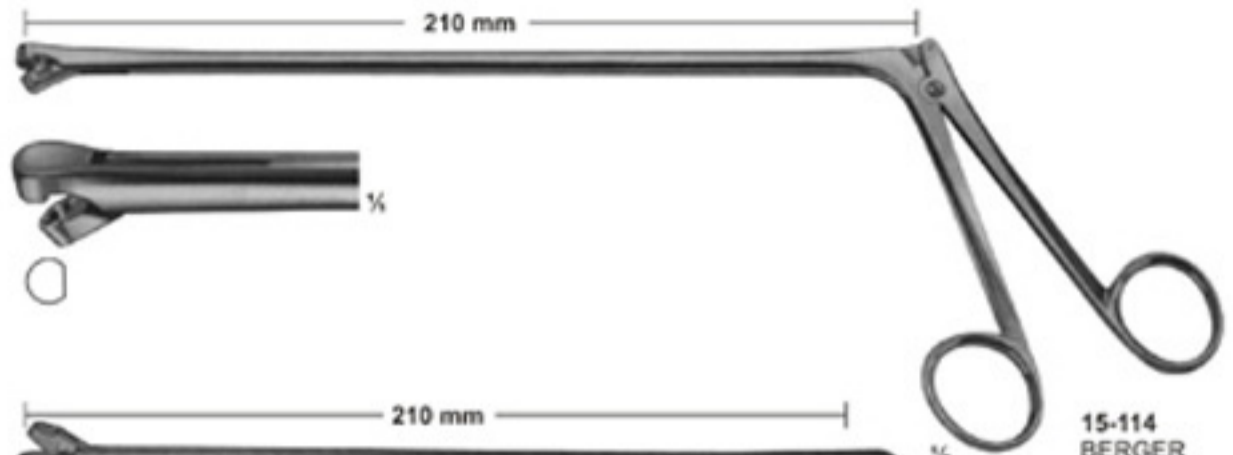

15-114 BERGER

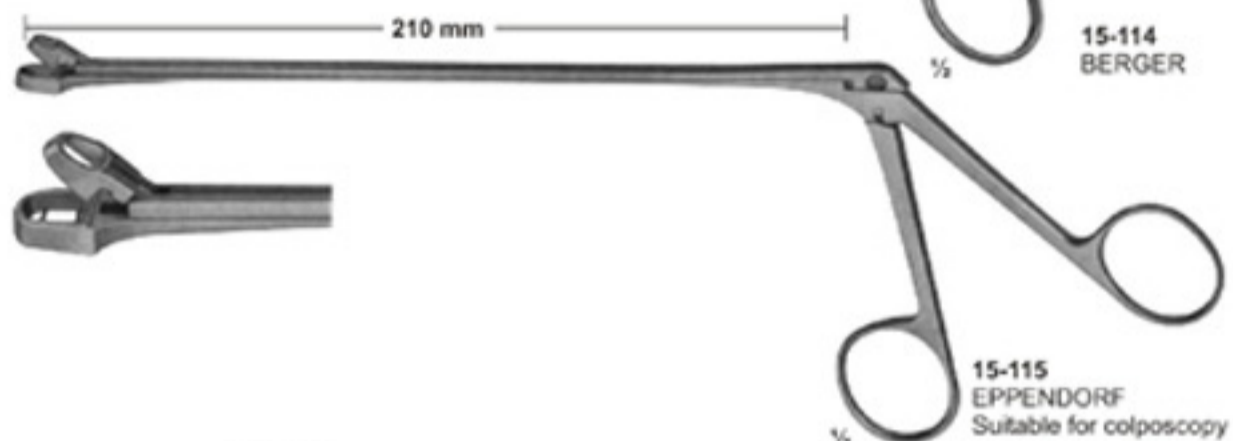

15-115 EPPENDORF
Suitable for colposcopy

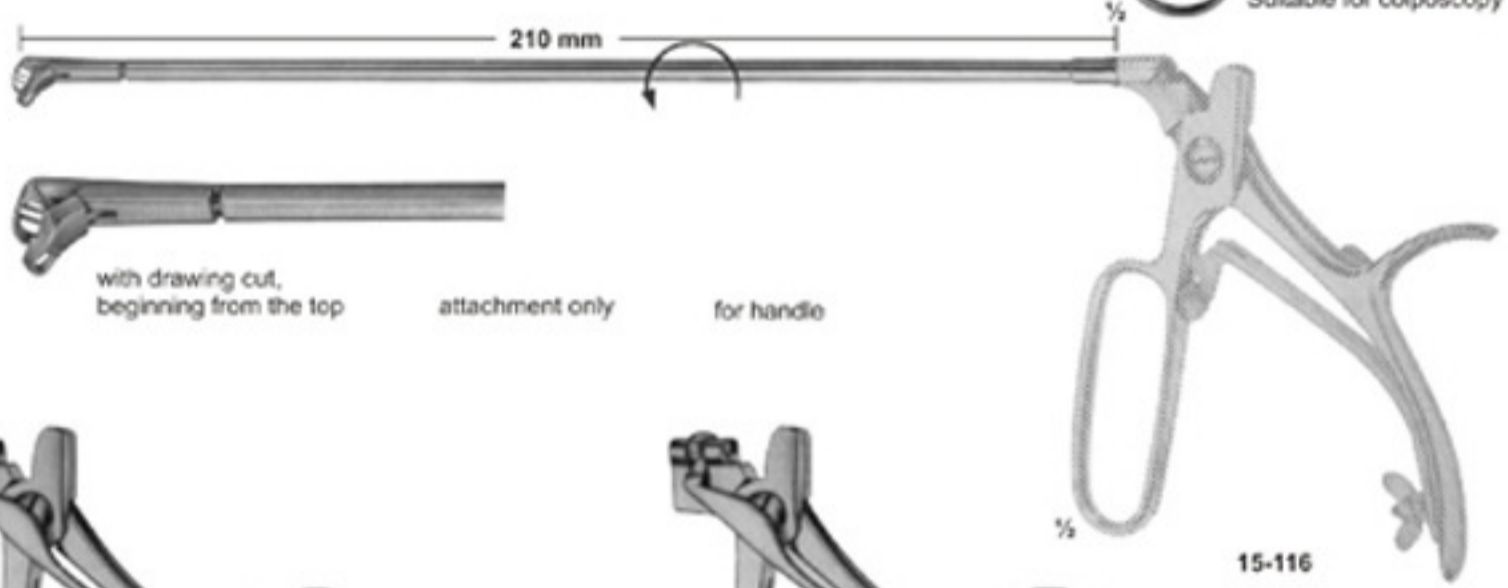

15-116



15-117
140 mm



15-118 HUBER
140 mm



Extension cannulae

15-119 BRUENINGS 200 mm Length
15-120 BRUENINGS 250 mm Length



15-121 KRAUSE (Biopsy tip)



15-122 SCHEINMANN (Biopsy tip)



15-123 SCHEINMANN (Biopsy tip)
with drawing cut

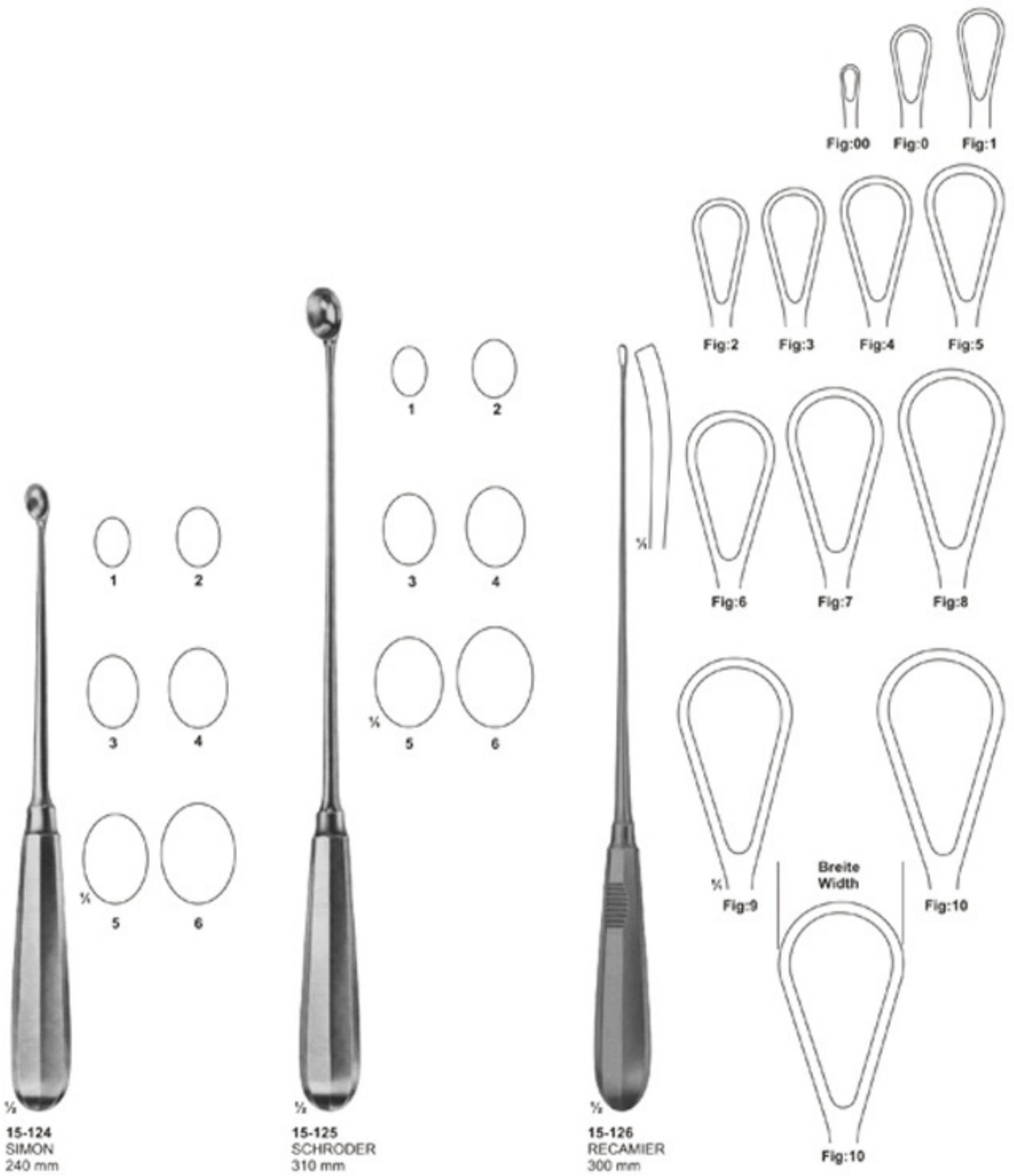

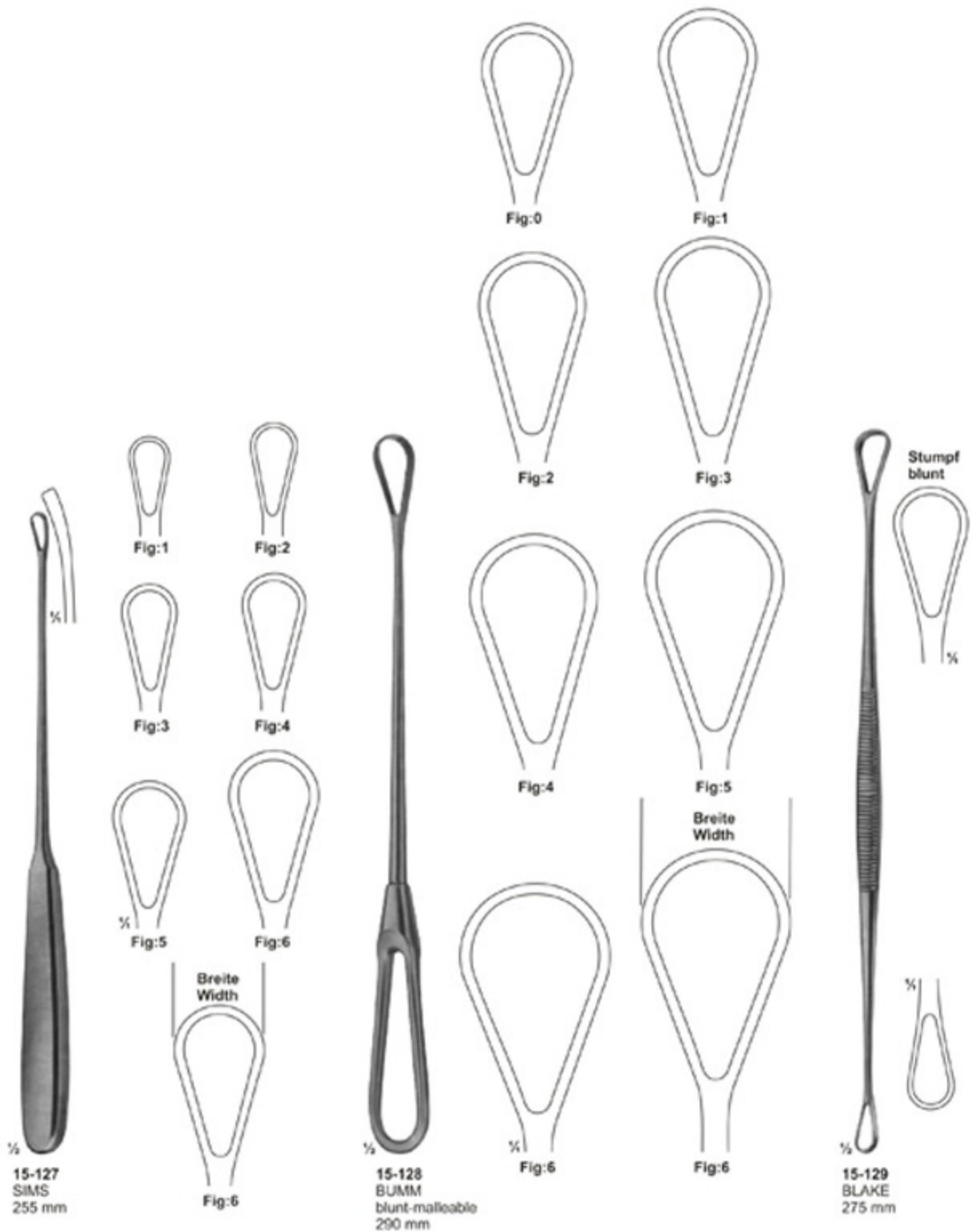



15-130
COLLIN
300 mm



15-131
RECAMIER
blunt-rigid
360 mm



Fig:1



Fig:2



15-132
BUMM
310 mm



Fig:1



Fig:2



Fig:3

15-133 - 138

Suction currettes, stainless steel, fitting hose connection.

Working tips are smoothly rounded of, therefore no danger of perforation.



(suitable for suction biopsy)

15-133: diam 4 mm

15-134: diam 6 mm

15-135: diam 8 mm

15-136: diam 10 mm

15-137: diam 12 mm

15-138: diam 14 mm

15-139

Hose connection inside diam. 11 mm curved stainless steel.



15-140

The new connection between suction currette and hose connection, Guarantees quick changing and free turning of the suction currettes on the hose connection.

15-141

Transparent suction hose 1.8 m long, inside diam 11 mm, outside diam 16.5 mm can be sterilized in an autoclave at 1 bar overpressure (120 C)



15-142

Strainer for tissues, plastic, for single use only, to be used for histopathological examination.



15-143 diam 8 mm
15-144 diam 10 mm
BOZEMANN-FRITSCH
Uterine Flushing Tube
350 mm

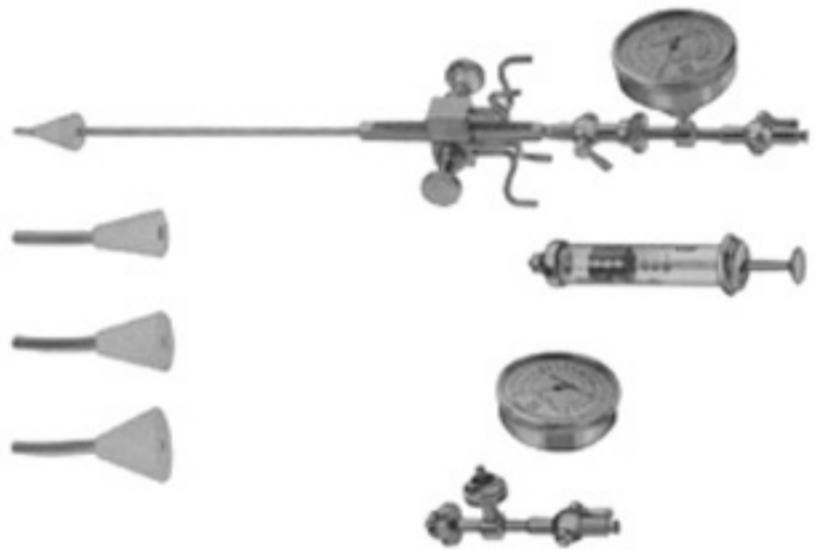

15-145
SCHULZE
Salpingograph, for utero-salpingography
in wooden case, consisting of:
Manometer, Connection, Uterine canula
with tap, Cone S.M.L.,
Record Syringe 10 cc, Luer lock mount.

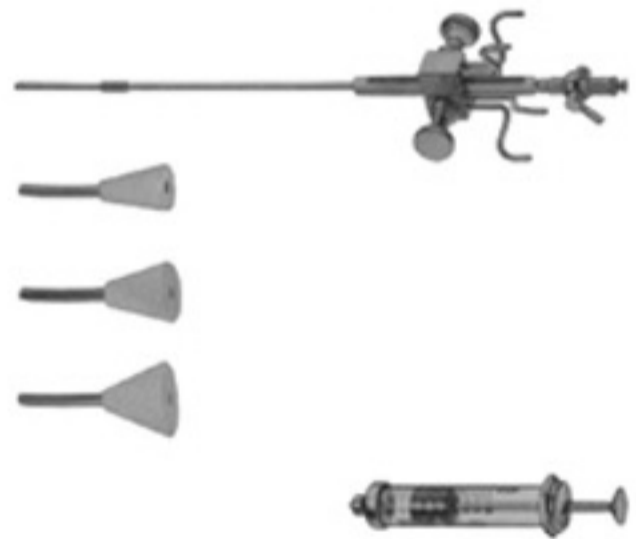

15-146
SCHULZE
Salpingograph, equipment
without manometer.





for internal measurements between symphysis and promontory

The additional straight arm can be replaced. The pelvimeter with straight arm is used for localisation of the portio vaginalis uteri and of vaginal metastasis.

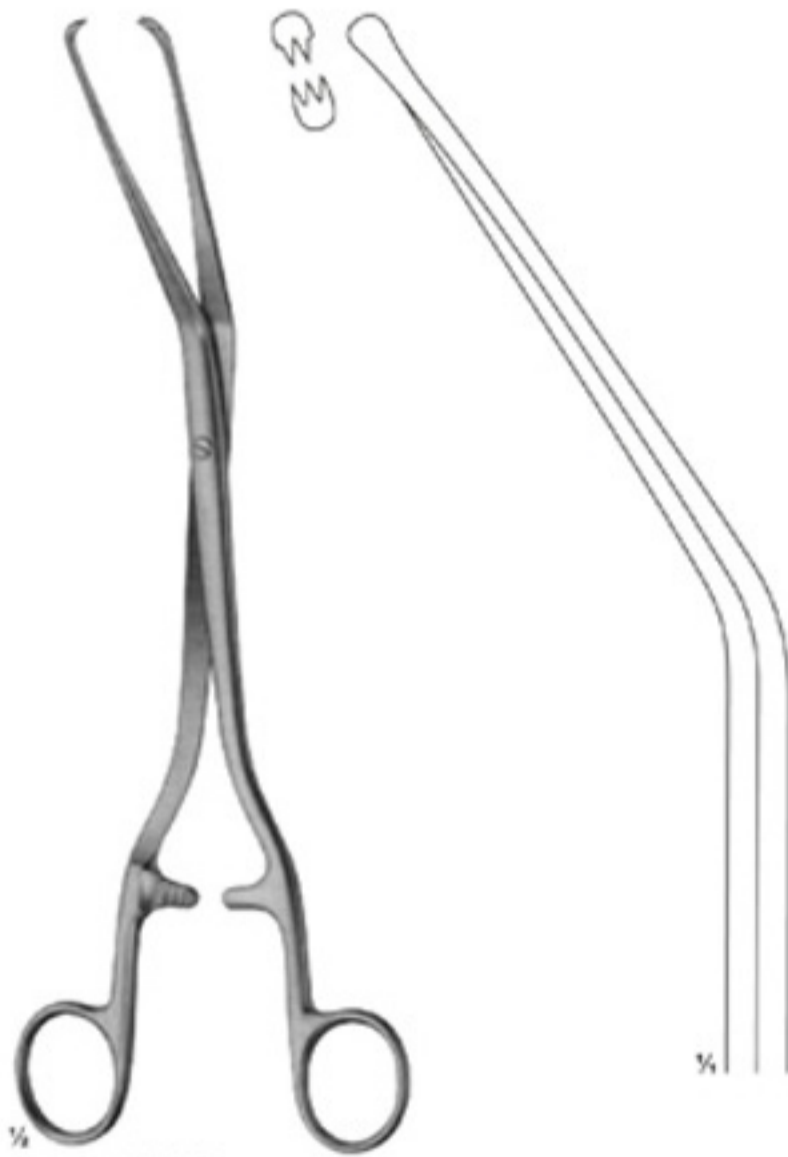

16-107
HERFF
puncturing forceps
225 mm



16-108
IOWA
puncturing forceps
260 mm



16-109
SCHUMACHER
Umbilical cord
scissors
155 mm



16-110
Umbilical cord
scissors
105 mm

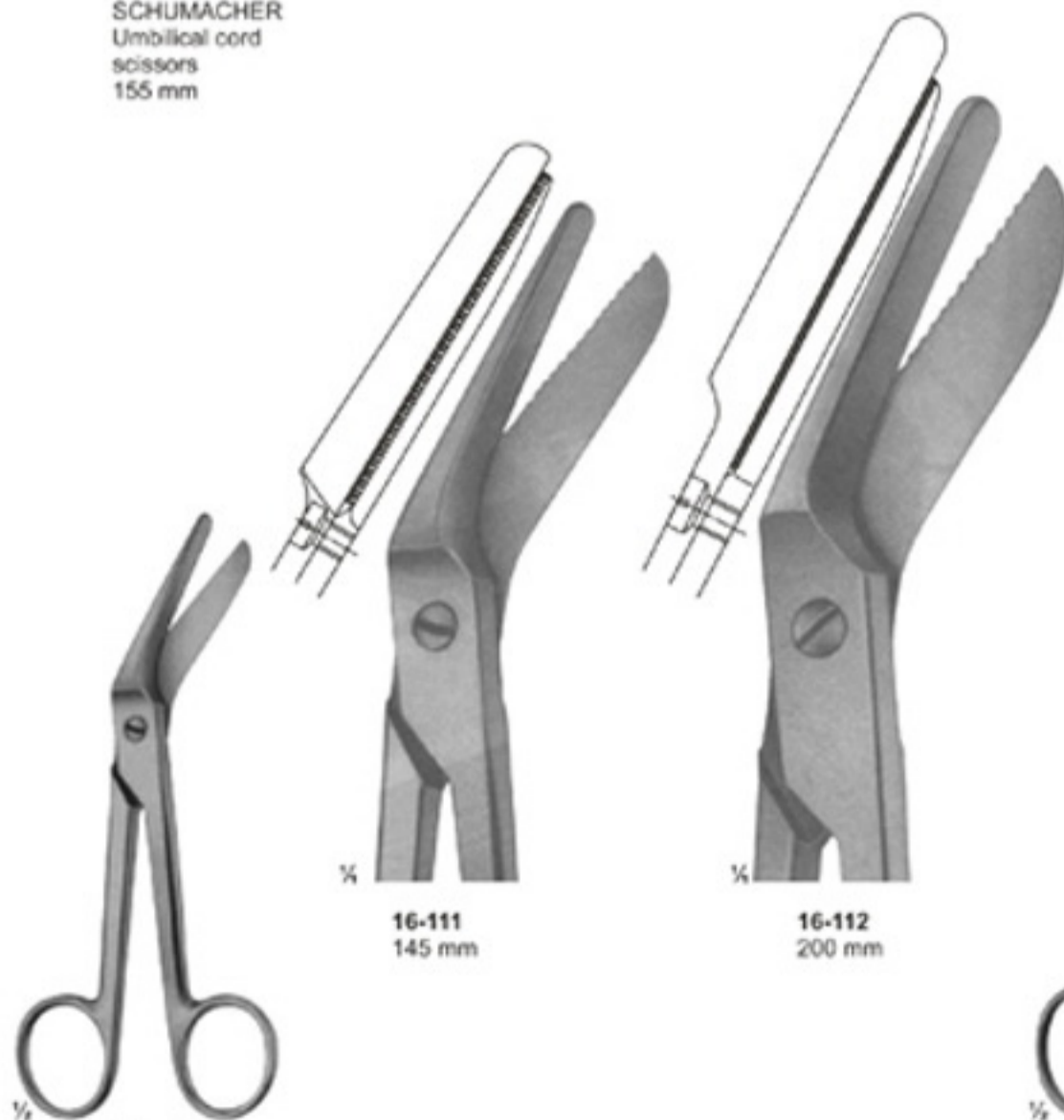

16-111
145 mm

16-112
200 mm

16-111 - 112
BRAUN-STADLER
Episiotomy Scissors

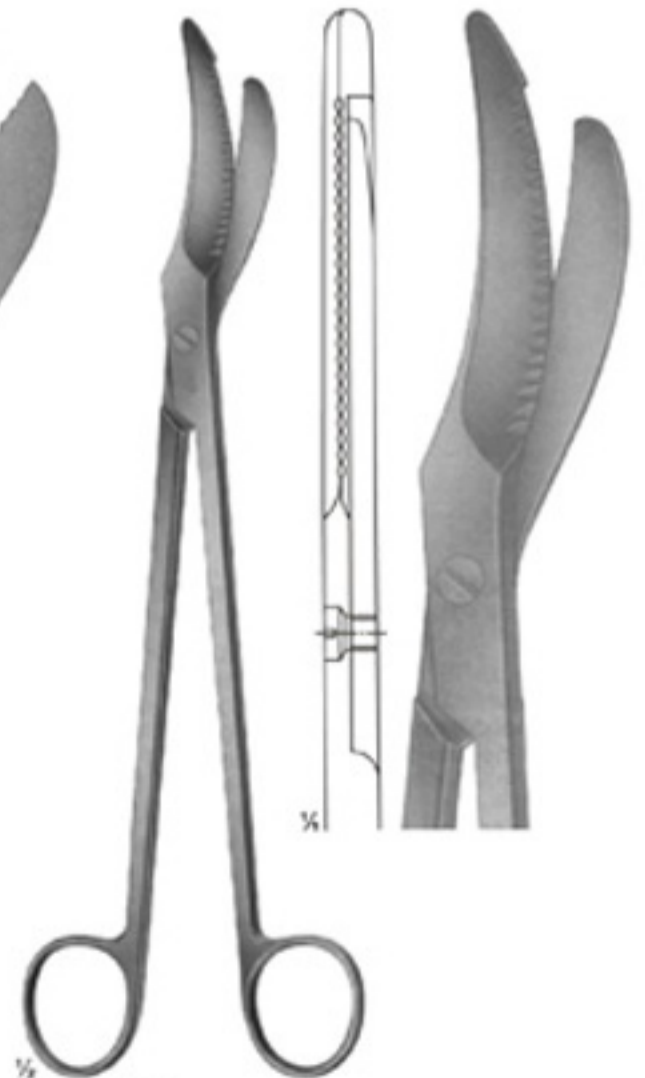

16-113
Episiotomy Scissors
240 mm



16-114
355 mm



16-115
400 mm



16-116
SIMPSON-BRAUN
305mm



16-117
SIMPSON-BRAUN
305mm



16-118
SIMPSON
235mm



16-119
WRIGLEY
250 mm



16-120
GREEN-ARMYTAGE
 Caesarean section haemostatic
 forceps, for edges of the transverse
 incision in the lower segment
 220 mm



16-121
WILLETT
 Scalpel Flap forceps
 185 mm



16-122
GAUSS
 Scalpel Flap forceps
 260 mm

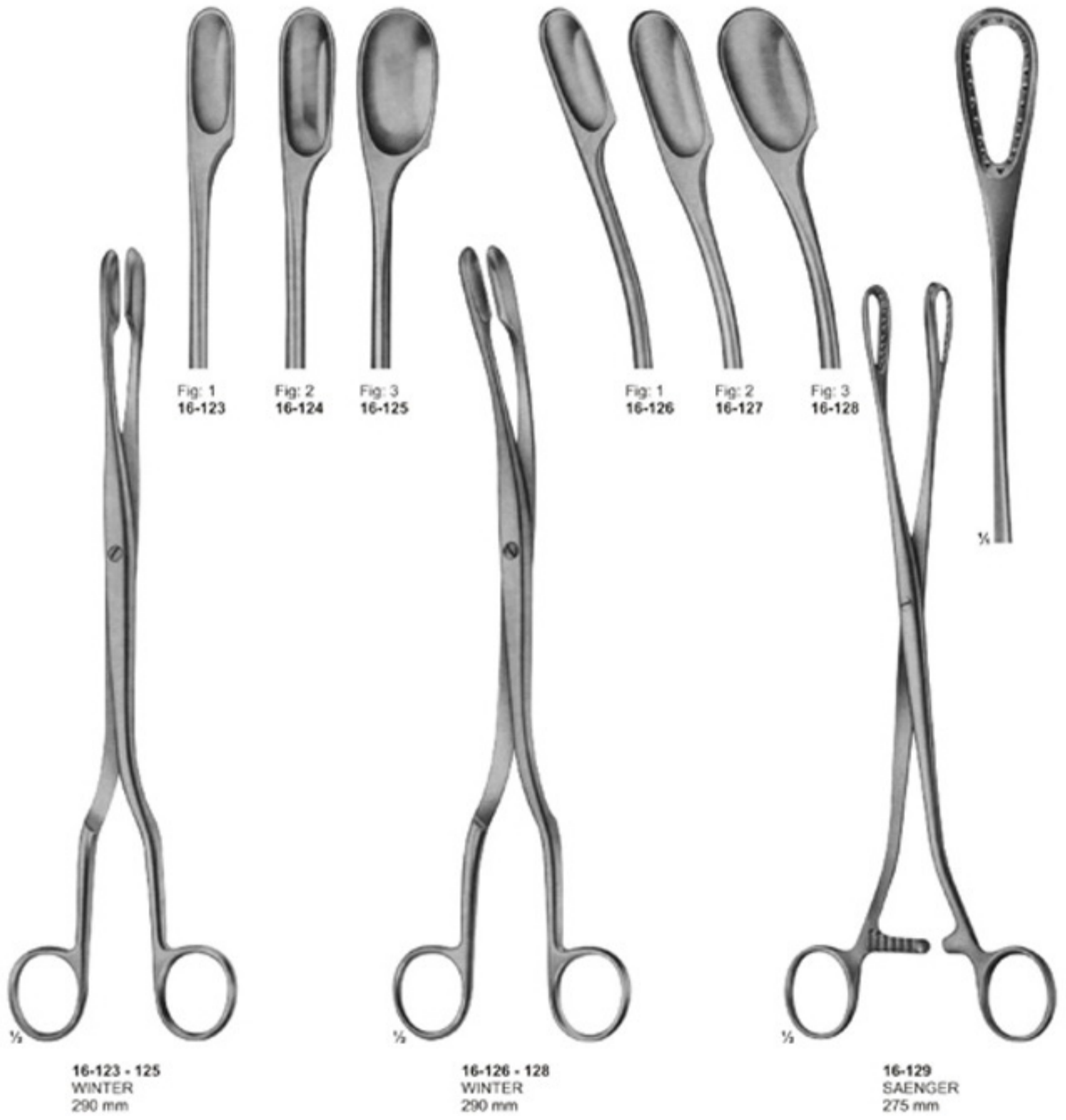



16-130
SAENGER
285 mm



16-131
SAENGER
285 mm



16-132

16-133



16-132 - 133
LEWKOWIZ
245 mm

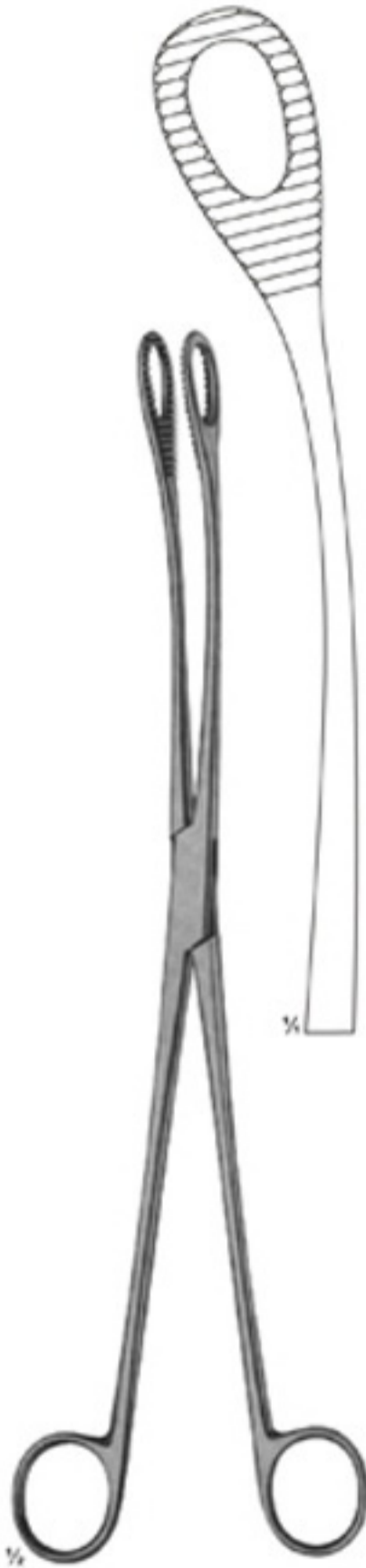

16-134
KELLY
320mm



16-135
SMELLIE
Perforator
270mm



16-136
BRAUN
Cranioclast
420mm



1/2

16-137
UECKERMANN-DENKER
 Cryothyrotomy trocar
 with silver cannula
 130mm

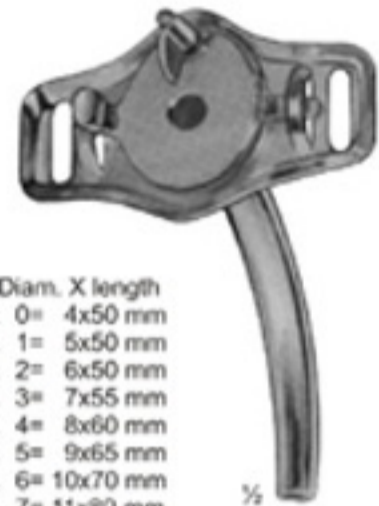

1/2

Diam. X length
16-138 Fig. 0= 4x50 mm
16-139 Fig. 1= 5x50 mm
16-140 Fig. 2= 6x50 mm
16-141 Fig. 3= 7x55 mm
16-142 Fig. 4= 8x60 mm
16-143 Fig. 5= 9x65 mm
16-144 Fig. 6= 10x70 mm
16-145 Fig. 7= 11x80 mm
16-146 Fig. 8= 12x85 mm
16-147 Fig. 9= 13x90 mm
16-148 Fig. 10= 14x90 mm

16-138 - 148
LUER
 German silver



1/2

16-149 - 158
JACKSON
 German Silver

Diam. X length
16-149 Fig. 0= 4x50 mm
16-150 Fig. 1= 5x58 mm
16-151 Fig. 2= 6x58 mm
16-152 Fig. 3= 7x70 mm
16-153 Fig. 4= 8x78 mm
16-154 Fig. 5= 9x84 mm
16-155 Fig. 6= 10x84 mm
16-156 Fig. 7= 11x86 mm
16-157 Fig. 8= 12x88 mm
16-158 Fig. 9= 13x90 mm



1/2

Diam. X length
16-159 Fig. 1= 5x48 mm
16-160 Fig. 2= 6x58 mm
16-161 Fig. 3= 7x70 mm
16-162 Fig. 4= 8x78 mm
16-163 Fig. 5= 9x84 mm
16-164 Fig. 6= 10x84 mm
16-165 Fig. 7= 11x86 mm
16-166 Fig. 8= 12x88 mm
16-167 Fig. 9= 13x90 mm
16-168 Fig. 10= 14x90 mm

16-159 - 168
JACKSON
 German Silver

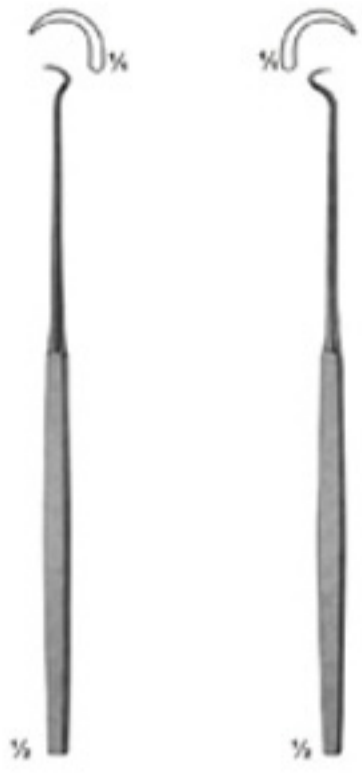

16-169
BOSE
165 mm

16-170
BOSE
165 mm



16-171
sharp



16-172
blunt



16-173
stumpf/blunt



16-174
FINSEN
50 mm



16-175
FINSEN
70 mm



16-176
TROUSSEAU
120 mm



16-177
LABORDE
125 mm



16-178
LABORDE
strong pattern
135 mm



16-179
Cleaning Brush
for tracheal tubes
285 mm

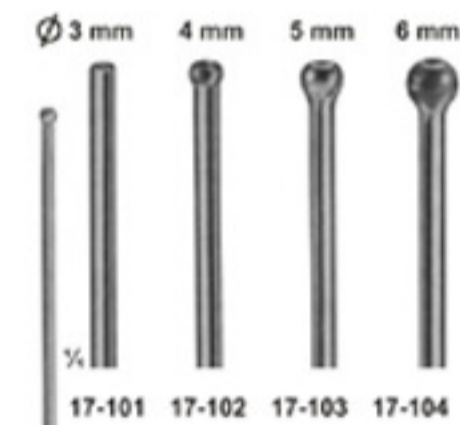

17-101 - 104
SCHMID
 Vessel irrigating cannulae,
 malleable, silver plated
 150 mm



17-105
BLAKE
 Embolus grasping
 forceps
 205 mm

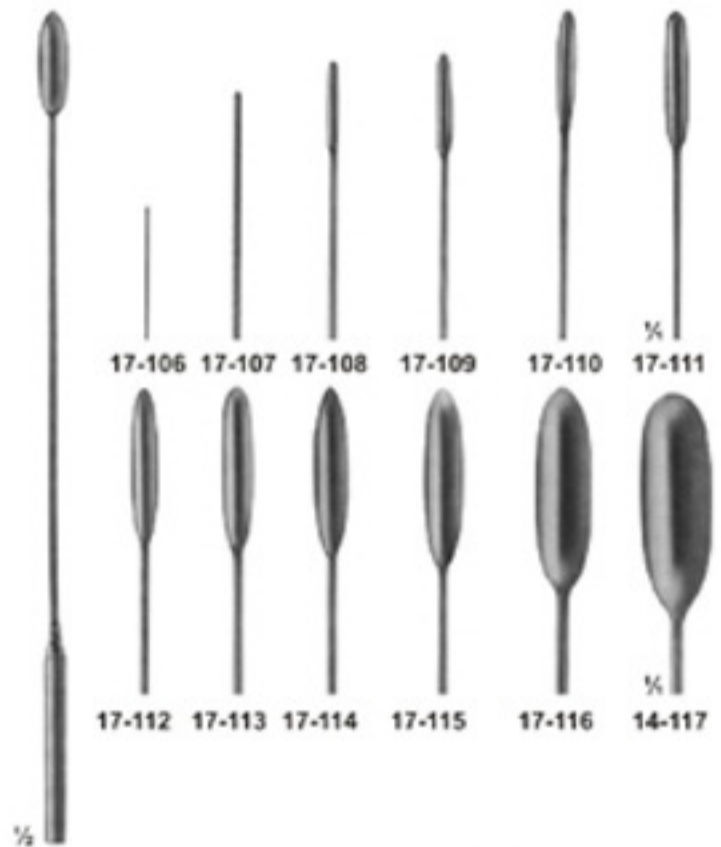

17-106 - 117
DE BAKERY
 Vascular dilators,
 malleable
 190 mm

17-106 0,5 mm Ø	17-112 3,5 mm Ø
17-107 1,0 mm Ø	17-113 4,0 mm Ø
17-108 1,5 mm Ø	17-114 4,5 mm Ø
17-109 2,0 mm Ø	17-115 5,0 mm Ø
17-110 2,5 mm Ø	17-116 7,0 mm Ø
17-111 3,0 mm Ø	17-117 9,0 mm Ø

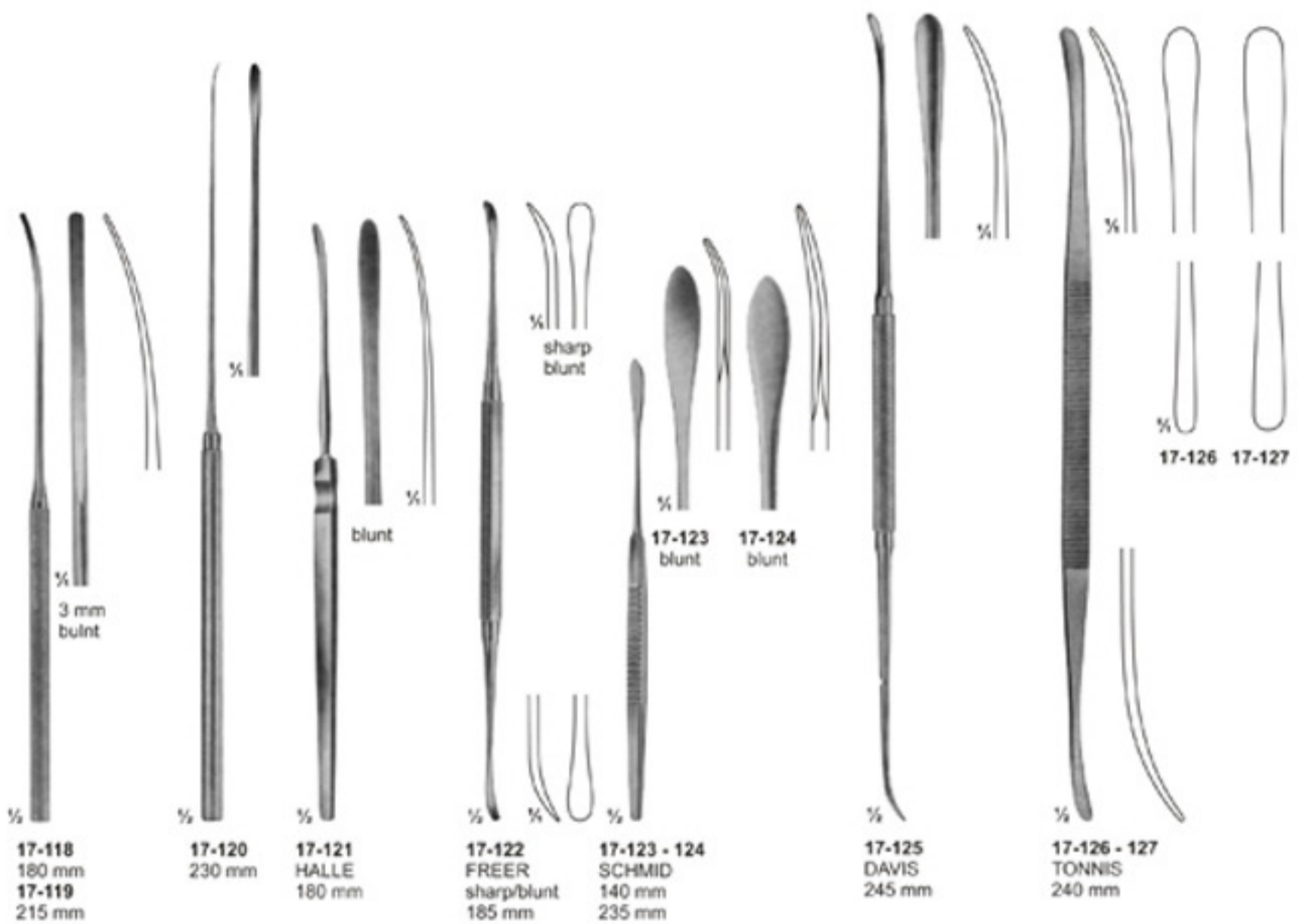

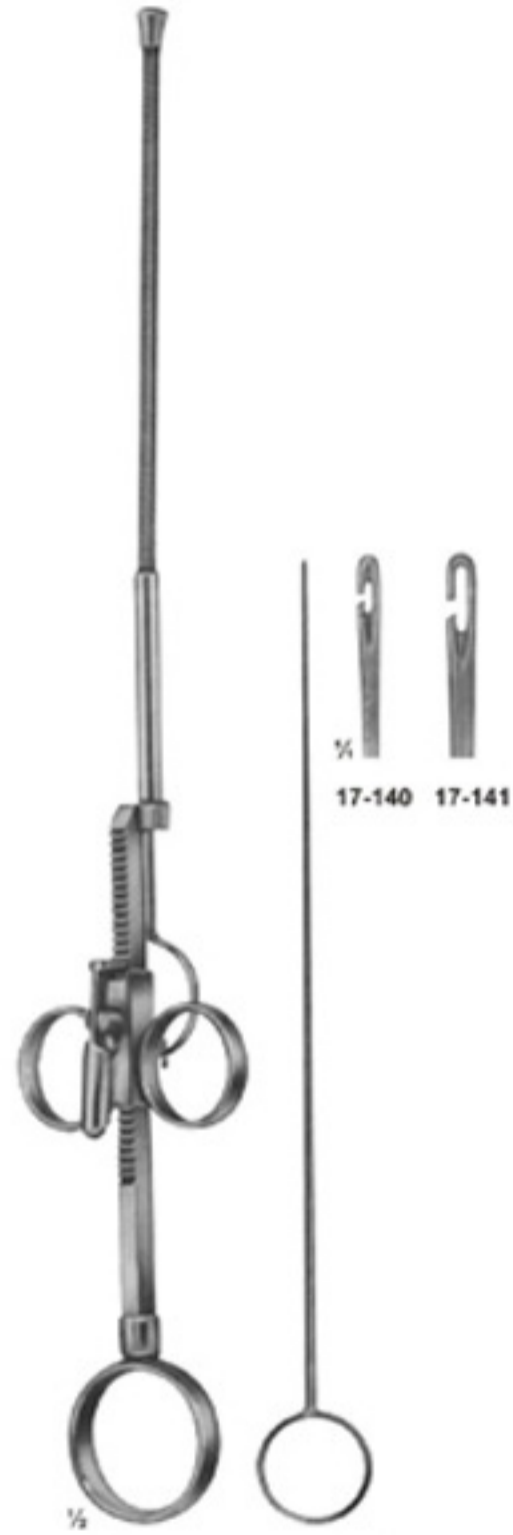
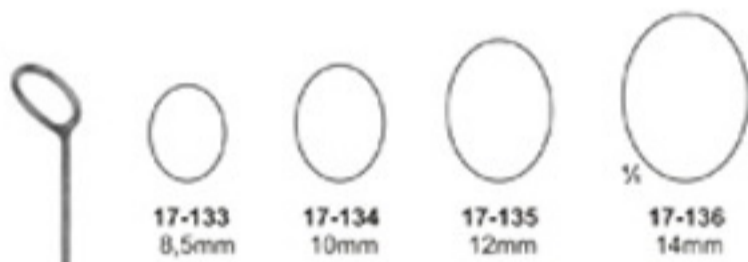

$\frac{1}{2}$
17-128 - 136
 Endarterectomy strippers
 550 mm

$\frac{1}{2}$
17-137
 Handle for
 110 mm

$\frac{1}{2}$
17-138 - 139
RUMEL-BELBONT
 325 mm
17-138 - 4,0 mm \varnothing
17-139 - 6,4 mm \varnothing

$\frac{1}{2}$
17-140 - 141
 Guide only

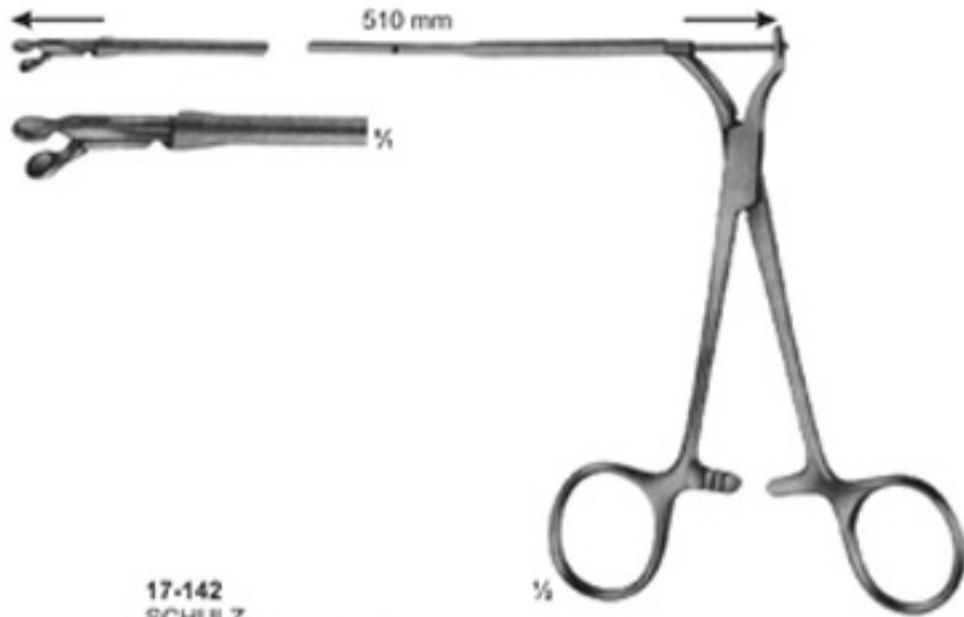

17-142

SCHULZ

Biopotome, mit flexiblem Schaft, 510 mm lang, with round jaws 3 mm diam.

Biopsy forceps, for biopsy from the right atrium through cava juglaris, prior to heart implantations.

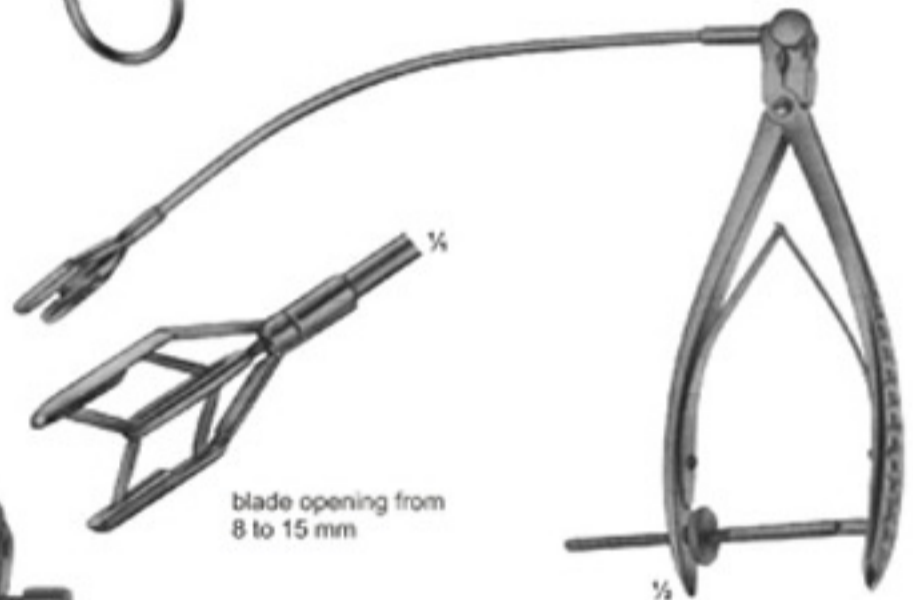

17-144

COOLEY
Dilator for mitral valve for children

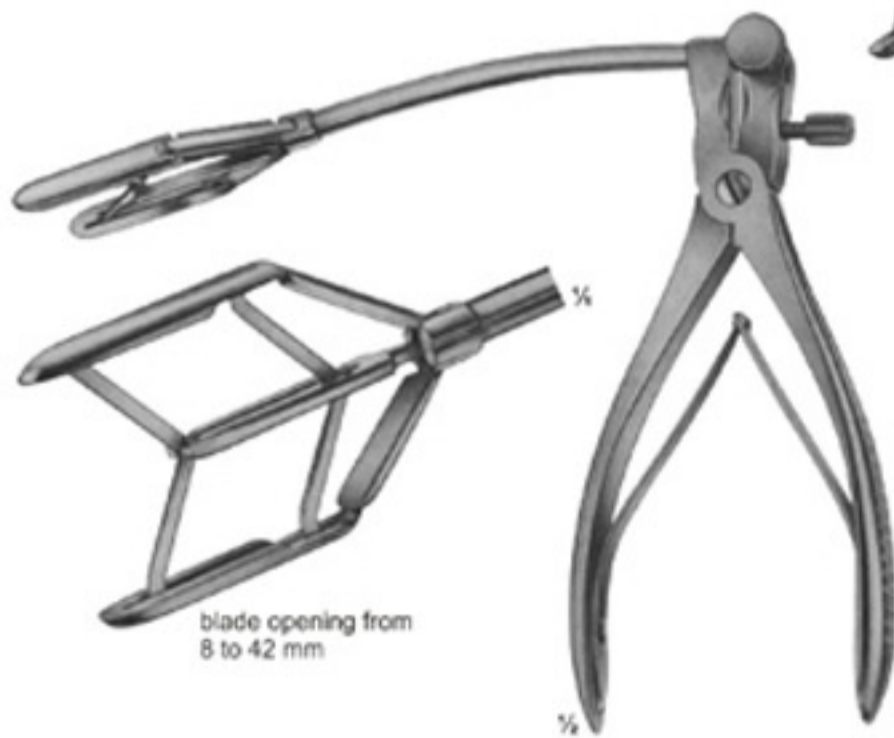

blade opening from 8 to 42 mm

17-143

TUBBS
Dilator for mitral valve

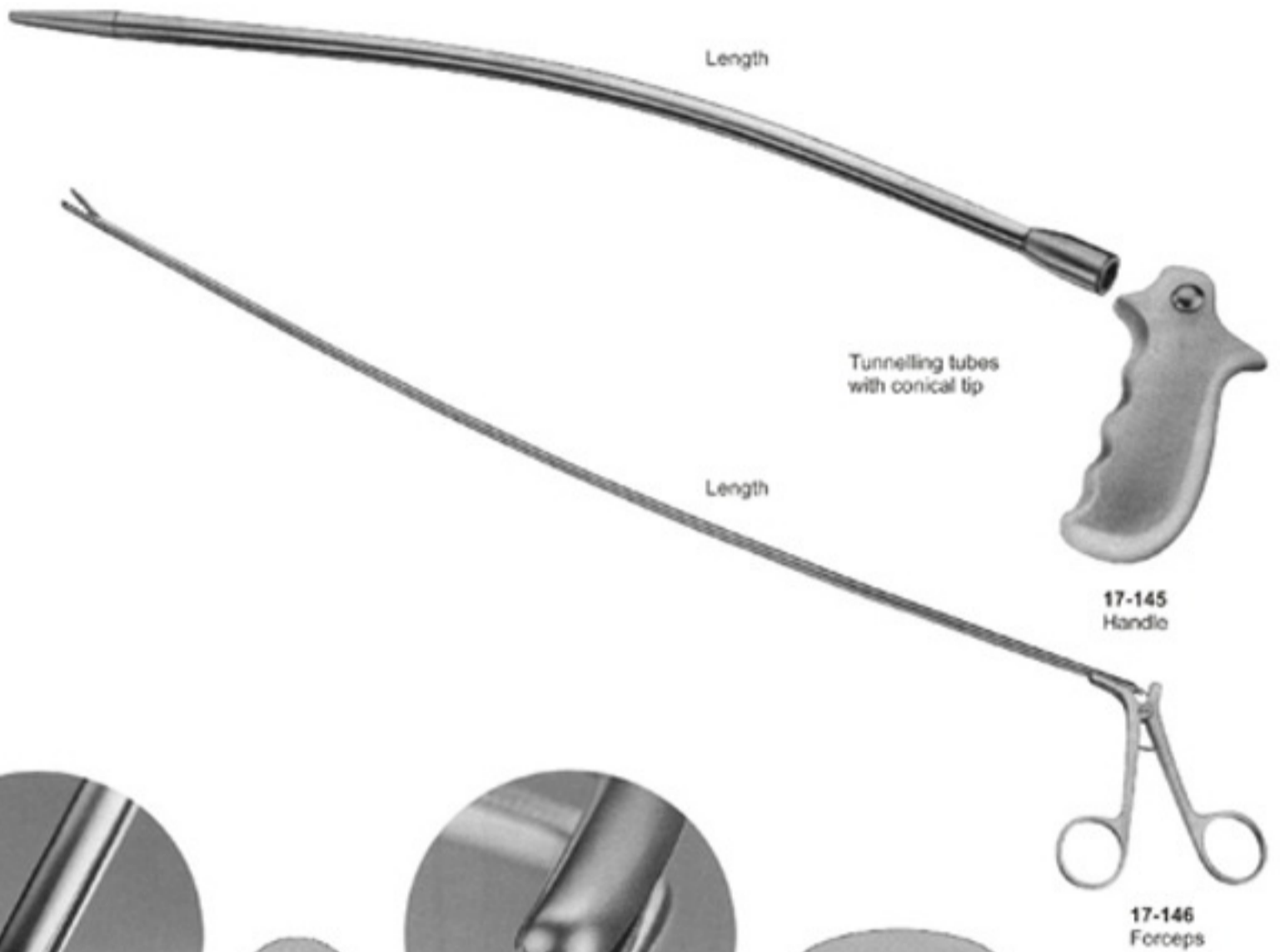

DE BAKEY
17-147
1 : 2 rows of teeth



DE BAKEY
17-148
2 : 3 rows of teeth

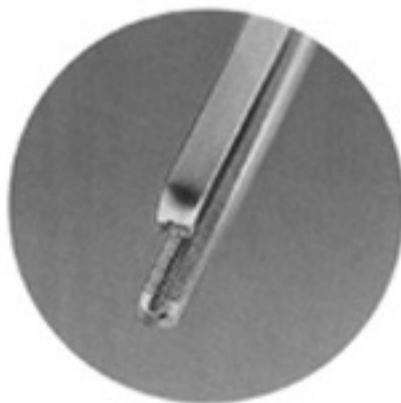

COOLEY
17-149
2 : 2 rows of teeth

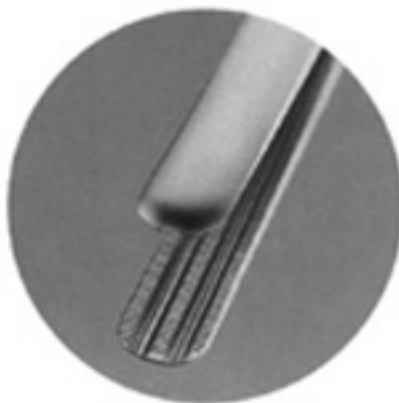

DARDIK
17-150
2 : 3 rows of teeth



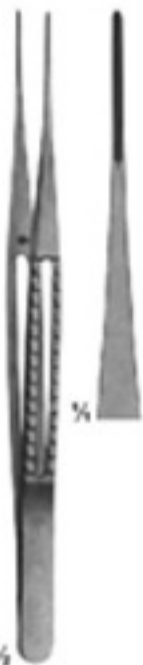

17-151
Width of jaws
1,5 mm
Length
150mm



17-152
1,5 mm
200 mm



17-153
1,5 mm
240 mm



17-154
1,5 mm
300 mm

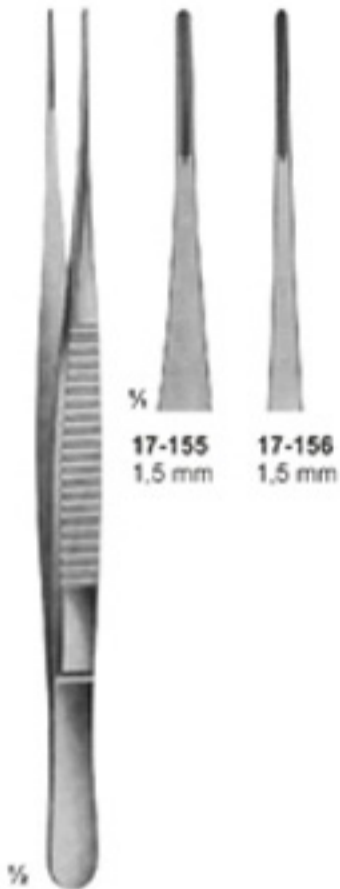

17-155 1,5 mm
17-156 1,5 mm

17-155 - 156
DE BAKEY
150 mm
300 mm



17-157 2 mm
17-158 2 mm
17-159 2 mm
17-160 2 mm

17-157 - 160
DE BAKEY
150 mm 200 mm
300 mm 240 mm

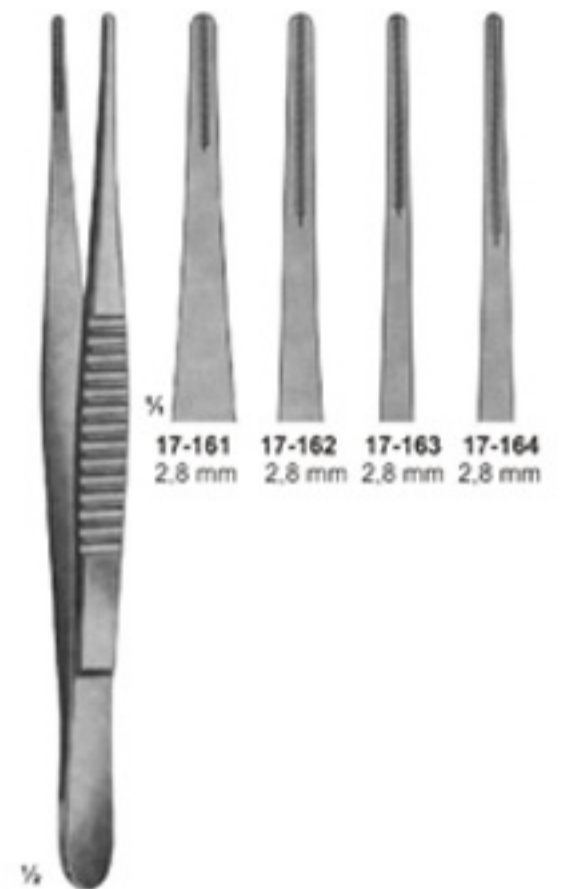

17-161 2,8 mm
17-162 2,8 mm
17-163 2,8 mm
17-164 2,8 mm

17-161 - 164
DE BAKEY
150 mm 200 mm
300 mm 240 mm

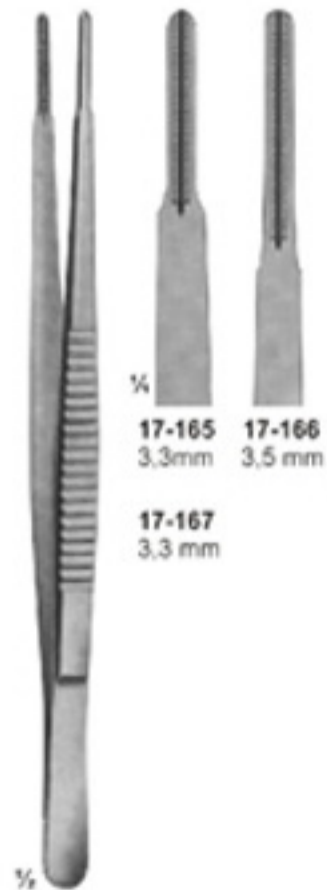

17-165 3,3mm
17-166 3,5 mm
17-167 3,3 mm

17-165 - 167
DE BAKEY
200 mm
300 mm 240 mm

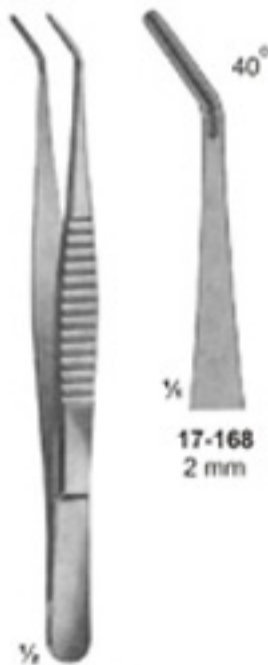

17-168
2 mm

17-168
DE BAKEY
150 mm

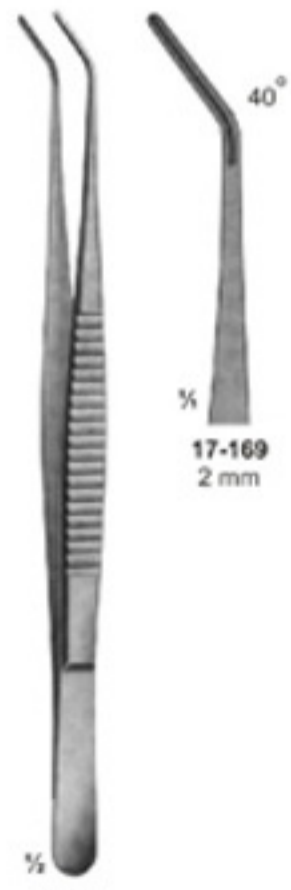

17-169
2 mm

17-169
DE BAKEY
200 mm



17-170
DE-BAKEY
gerade straight
130 mm



17-171
DE-BAKEY
Maul gebogen
curved jaws
125 mm

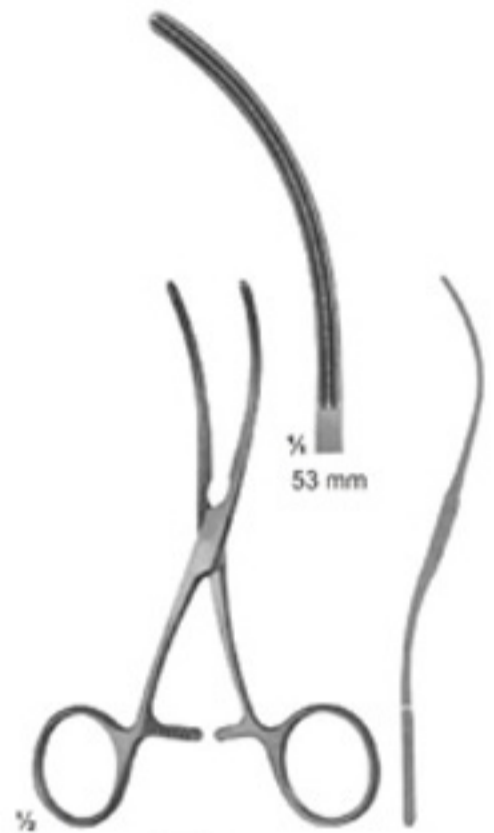

17-172
DE-BAKEY
S-shaped curved
125 mm

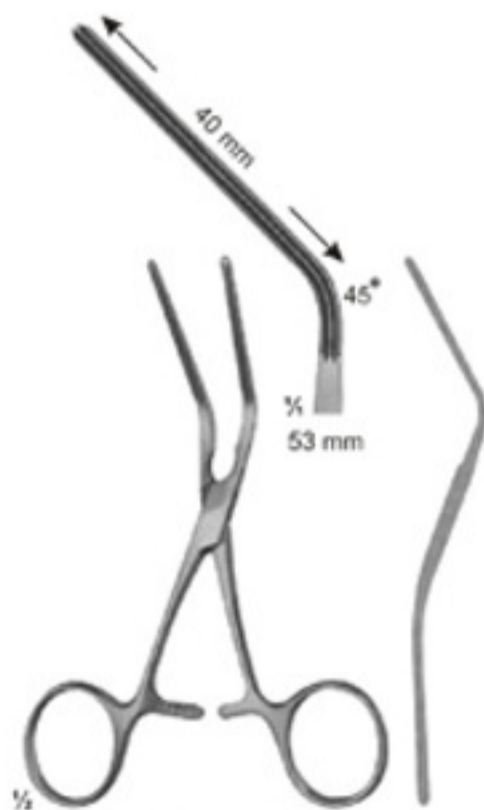

17-173
DE-BAKEY
45° winklig gebogen
angled 45°
125 mm

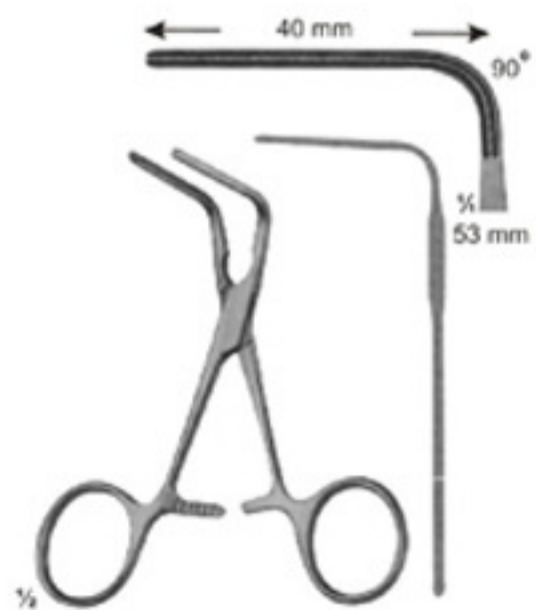

17-174
DE-BAKEY
90° winklig gebogen
angled 90°
105 mm

graduated



1/2

17-175 - 178
CASTANESA

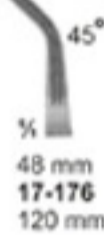

graduated



1/2

17-179 - 182
CASTANESA

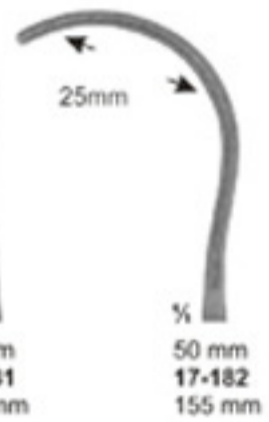
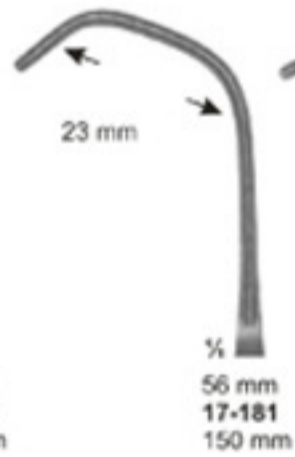
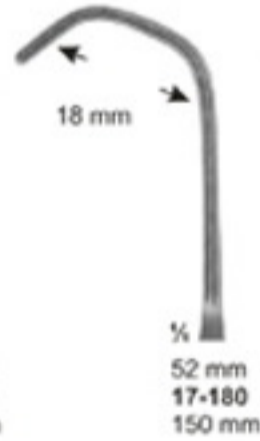
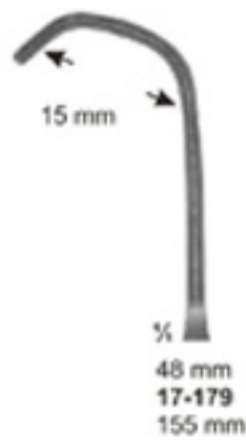

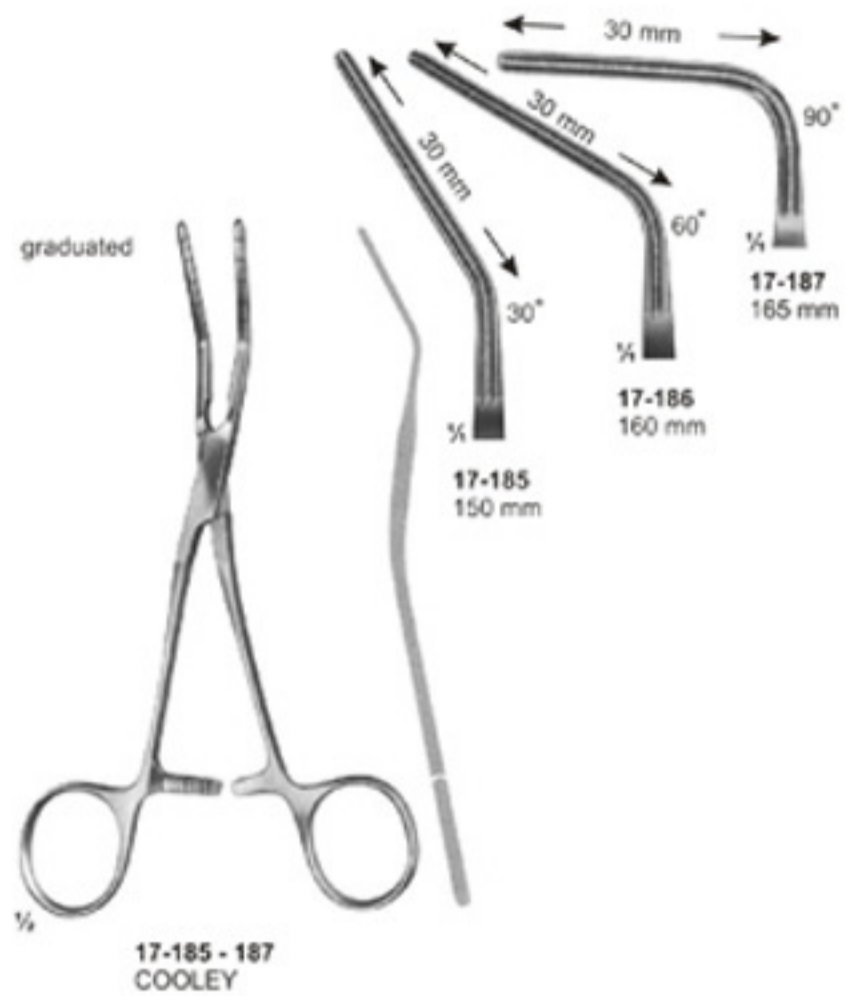
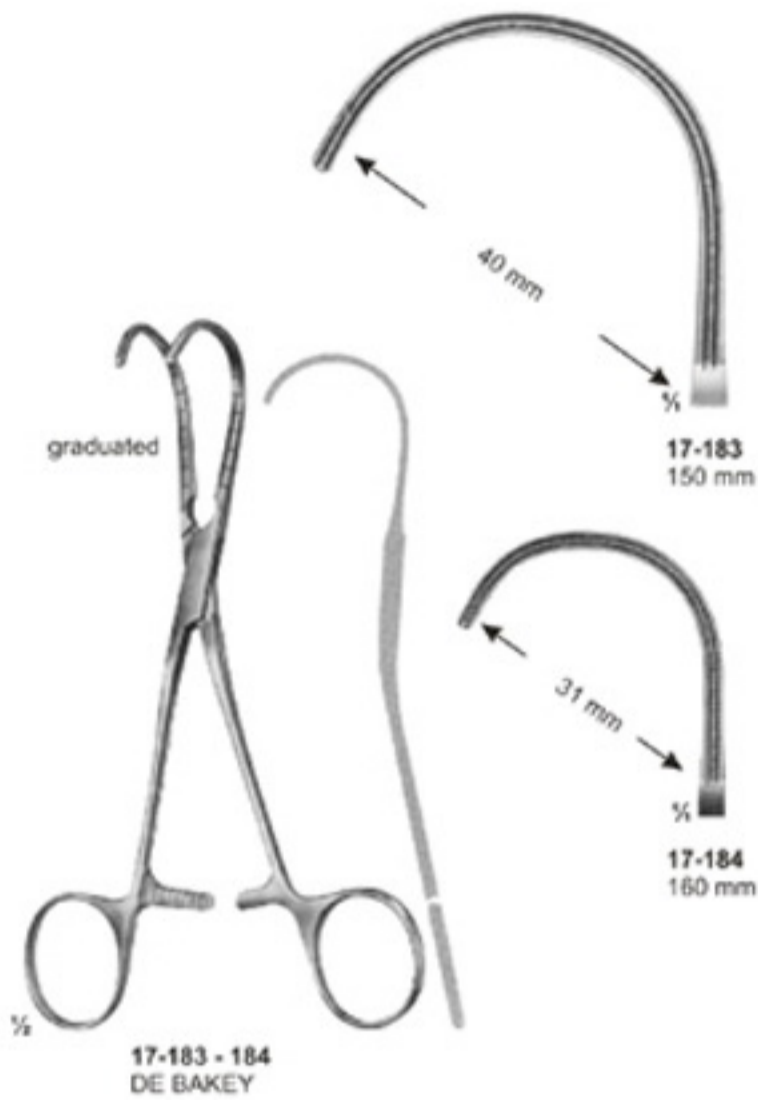



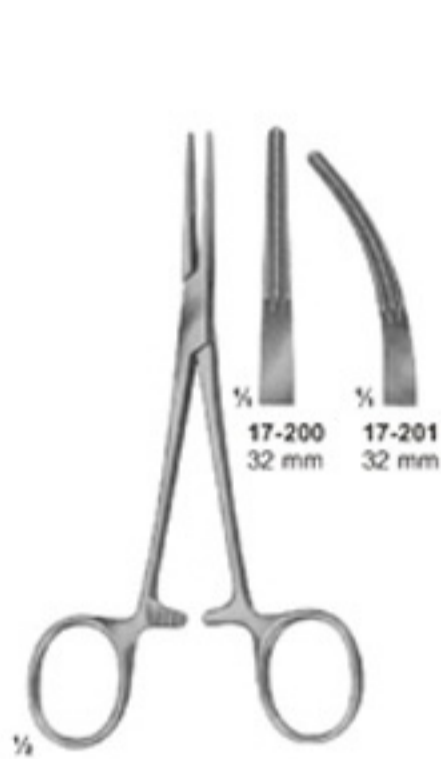

17-200 - 201
DE-BAKEY-KELLY
140 mm

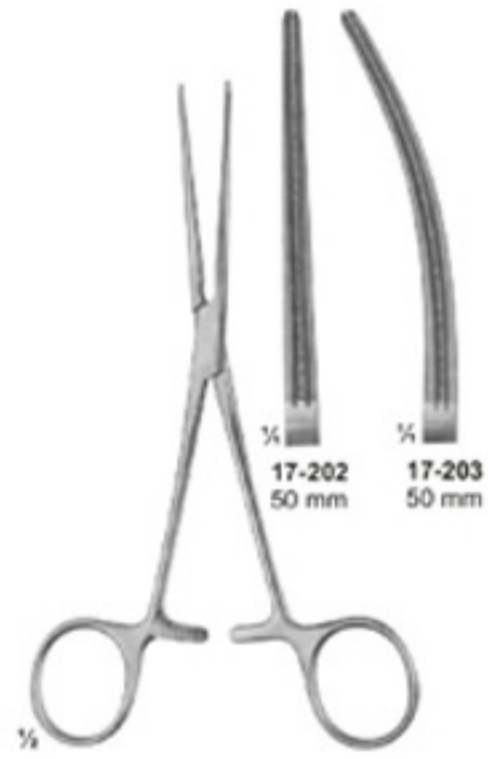

17-202 - 203
PEAN
155 mm

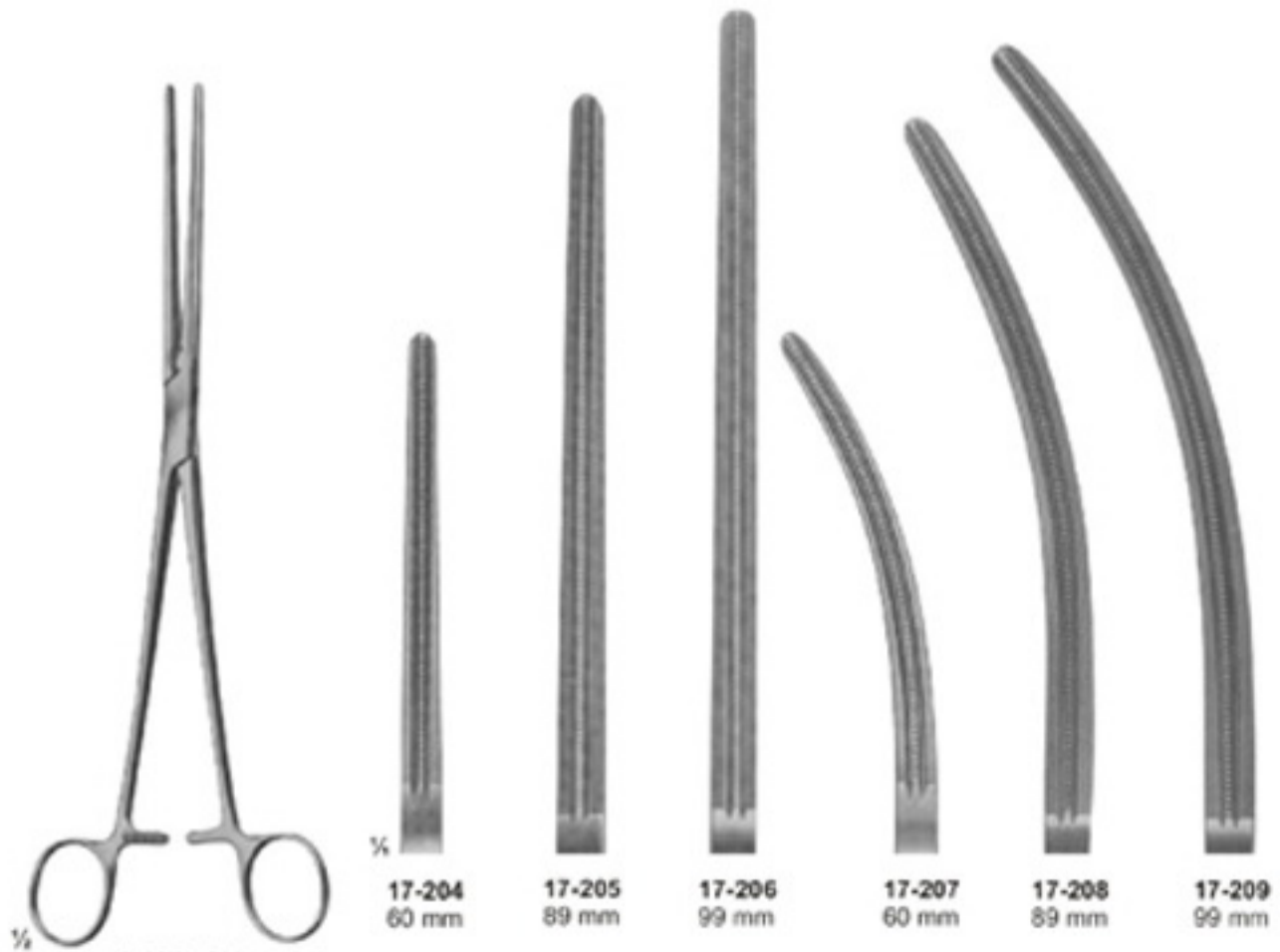

17-204 - 209
DE-BAKEY-PEAN DE-BAKEY-PEAN
17-204 200 mm 17-207 200 mm
17-205 265 mm 17-208 260 mm
17-206 280 mm 17-209 275 mm

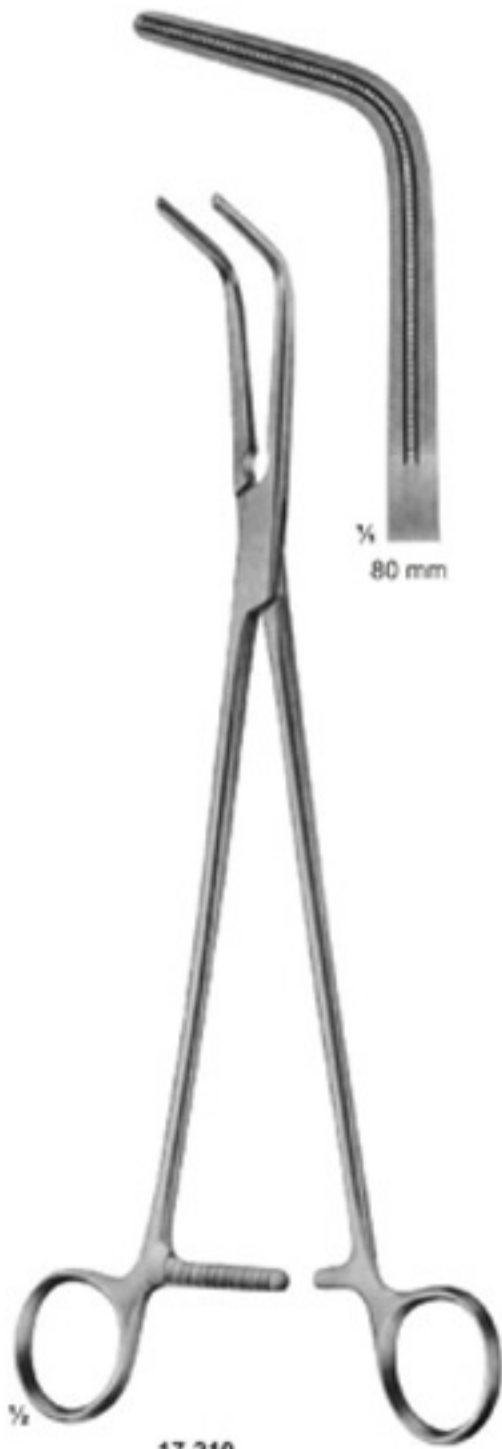

17-210
DE-BAKEY-MIXTER
285 mm

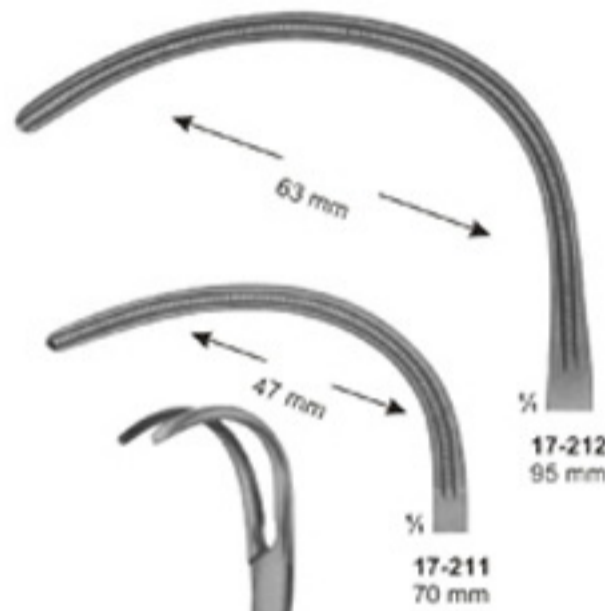

17-211
70 mm

17-212
95 mm



17-213
60 mm

17-213
GLOVER
220 mm

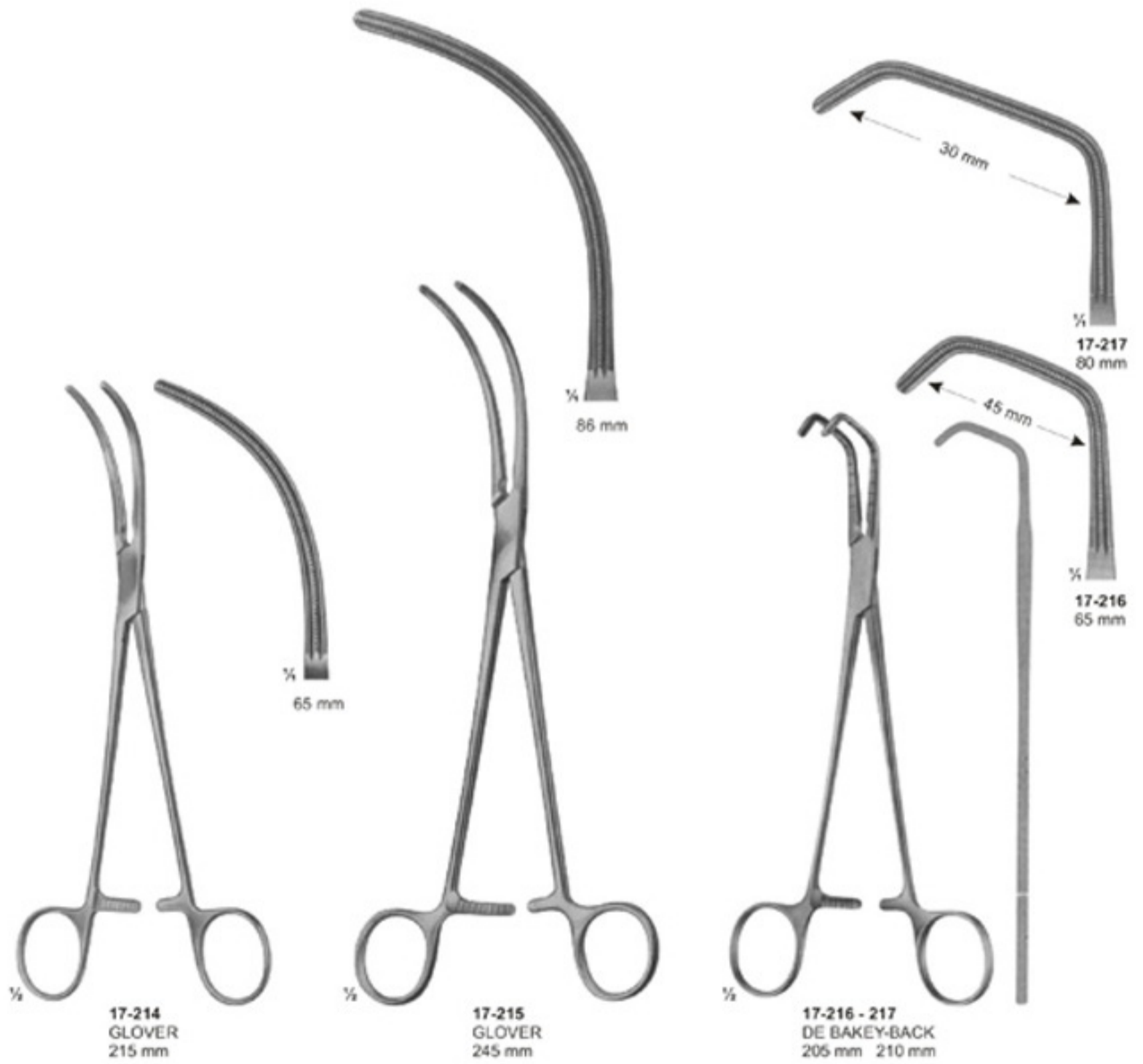



17-218 - 221
DE BAKHEY-HARKEN
 17-218 - 255 mm
 17-219 - 245 mm
 17-220 - 245 mm
 17-221 - 245 mm



17-222 - 226
DE BAKHEY

Total Length: 220 mm
 Length of jaws: 85 mm

17-222
 Total Length: 220 mm
 Length of jaws: 85 mm

17-223
 Total Length: 256 mm
 Length of jaws: 95 mm

17-224
 Total Length: 270 mm
 Length of jaws: 99 mm

17-225
 Total Length: 270 mm
 Length of jaws: 103 mm

17-226
 Total Length: 280 mm
 Length of jaws: 119 mm



17-227 - 229
DE BAKEY-SATINSKY
235 mm, 240 mm, 245 mm

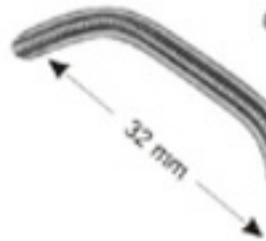

17-227
68 mm

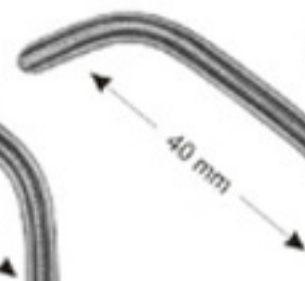

17-228
76 mm

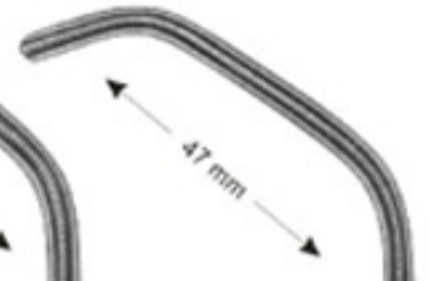

17-229
84 mm

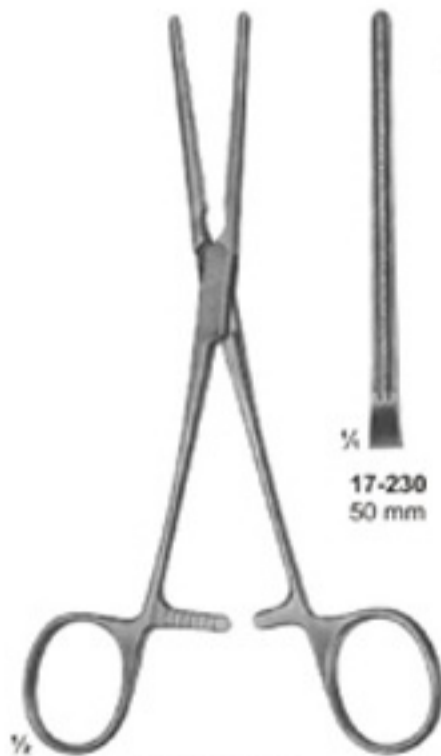

17-230 - 231
DE BAKEY
170 mm, 165 mm



17-230
50 mm



17-231
50 mm



17-232
DE BAKEY
165 mm



50 mm

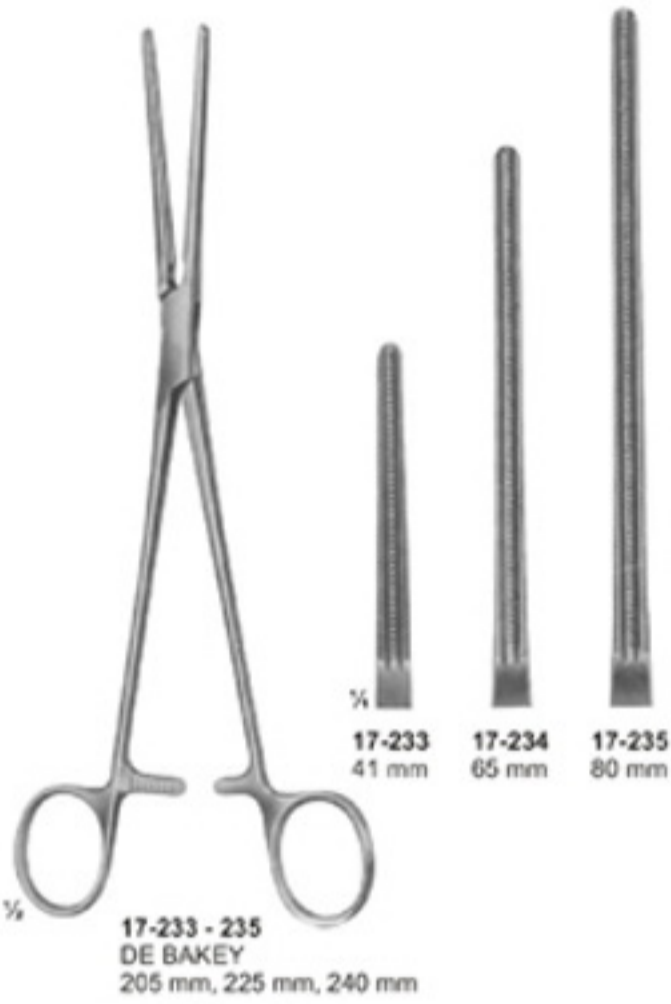

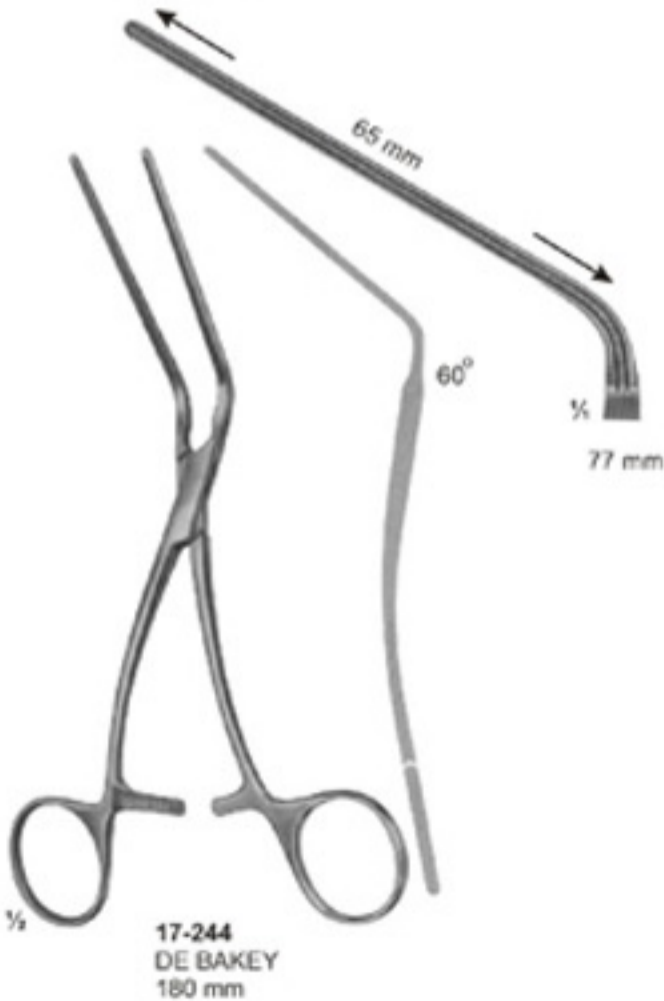
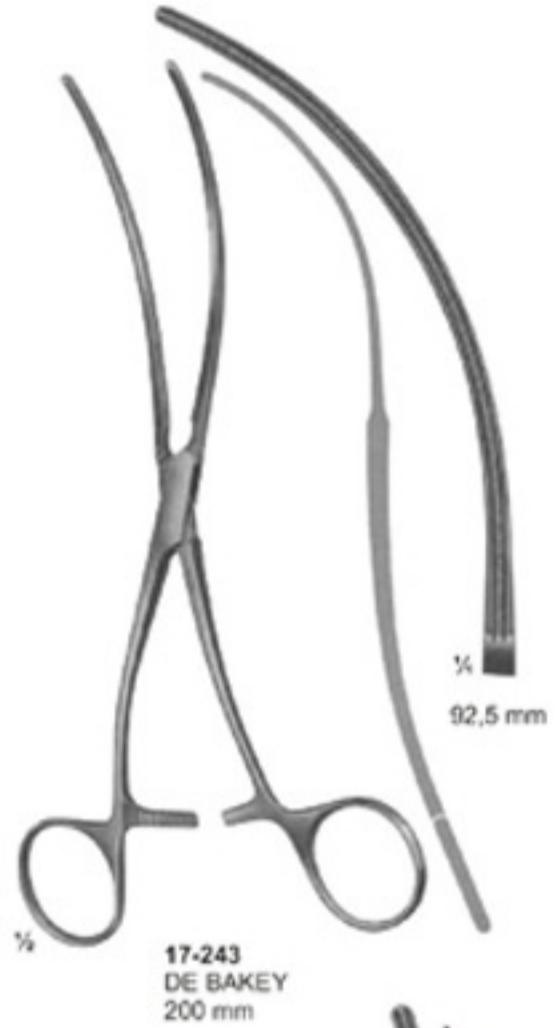



1/4
77 mm

17-247
LELAND-JONES
195 mm



1/4

Iliac clamp

17-248
DE BAKEY
200 mm



90°
1/4
67 mm

17-249
WERTHEIM
250 mm

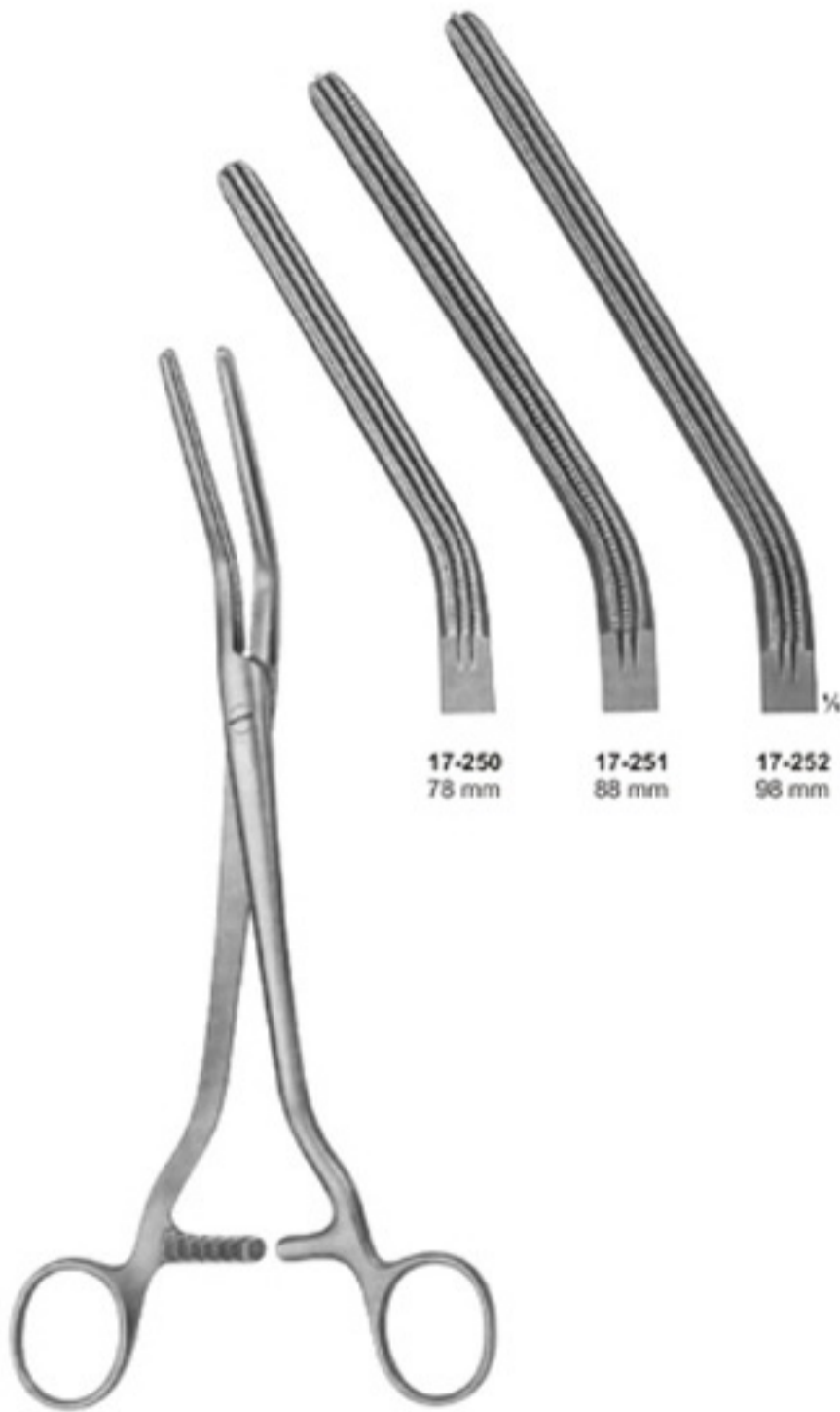

17-250 - 252
DICK
255 mm, 265 mm, 275 mm



17-253
MORRIS
175 mm

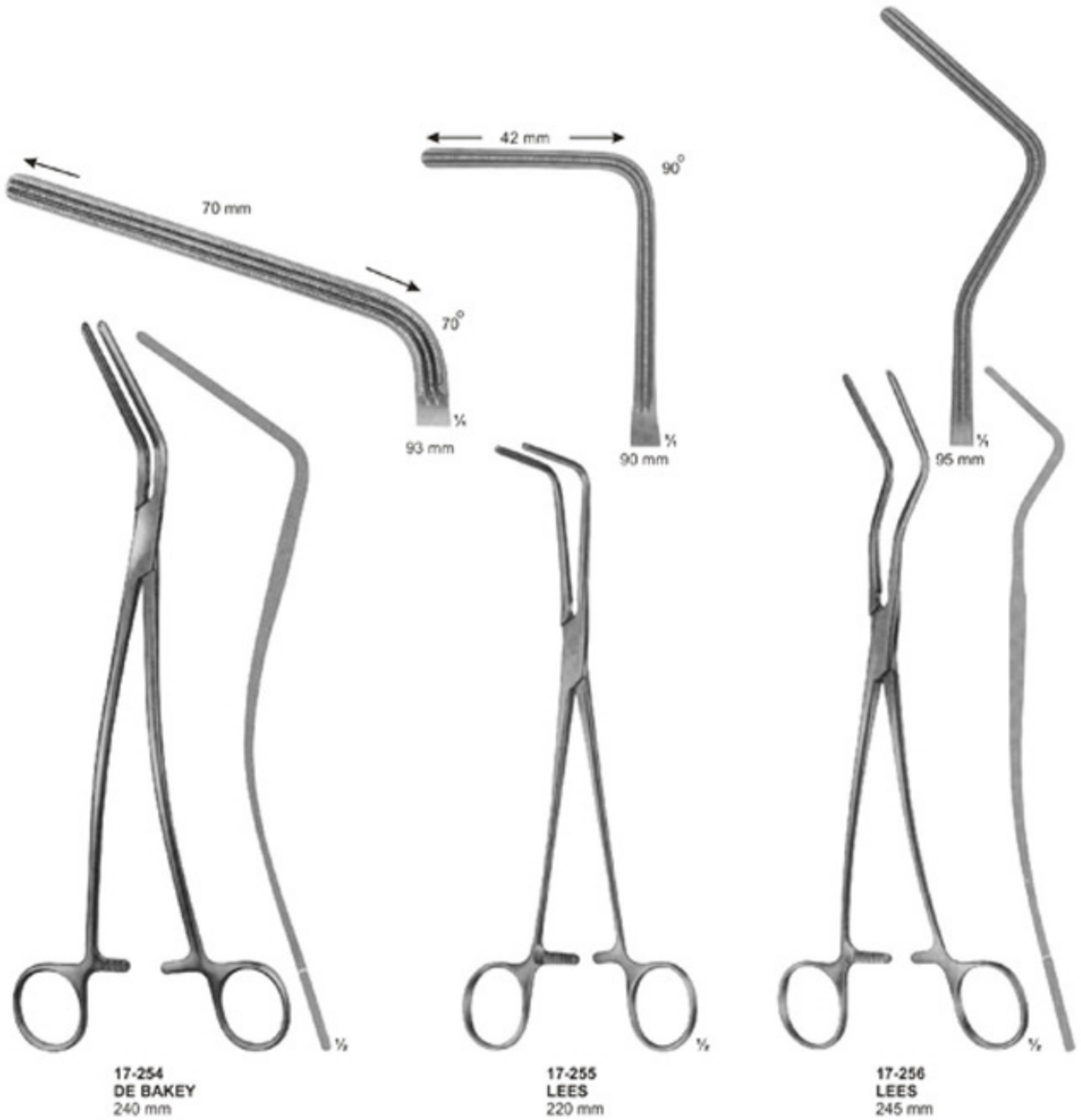

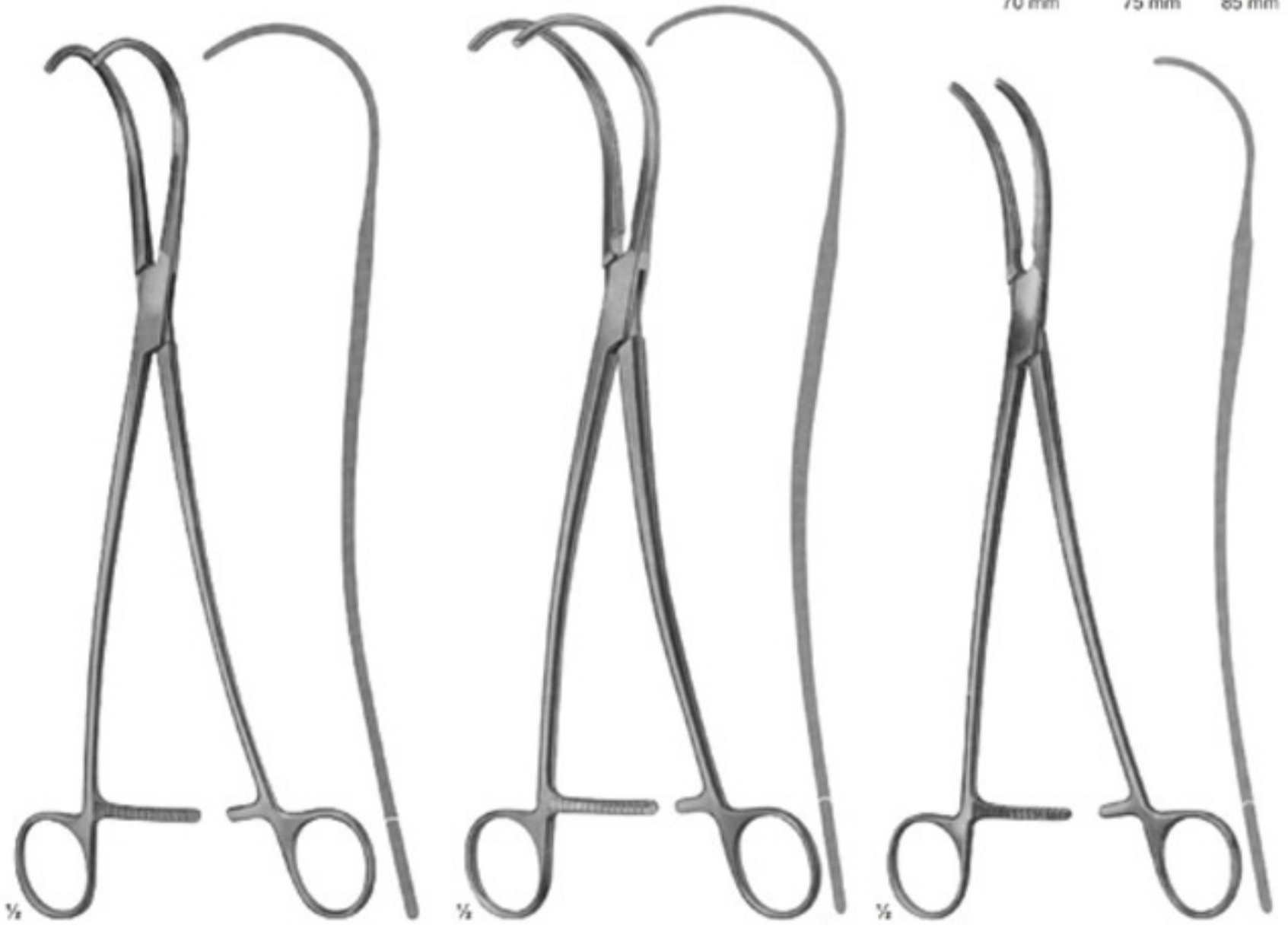
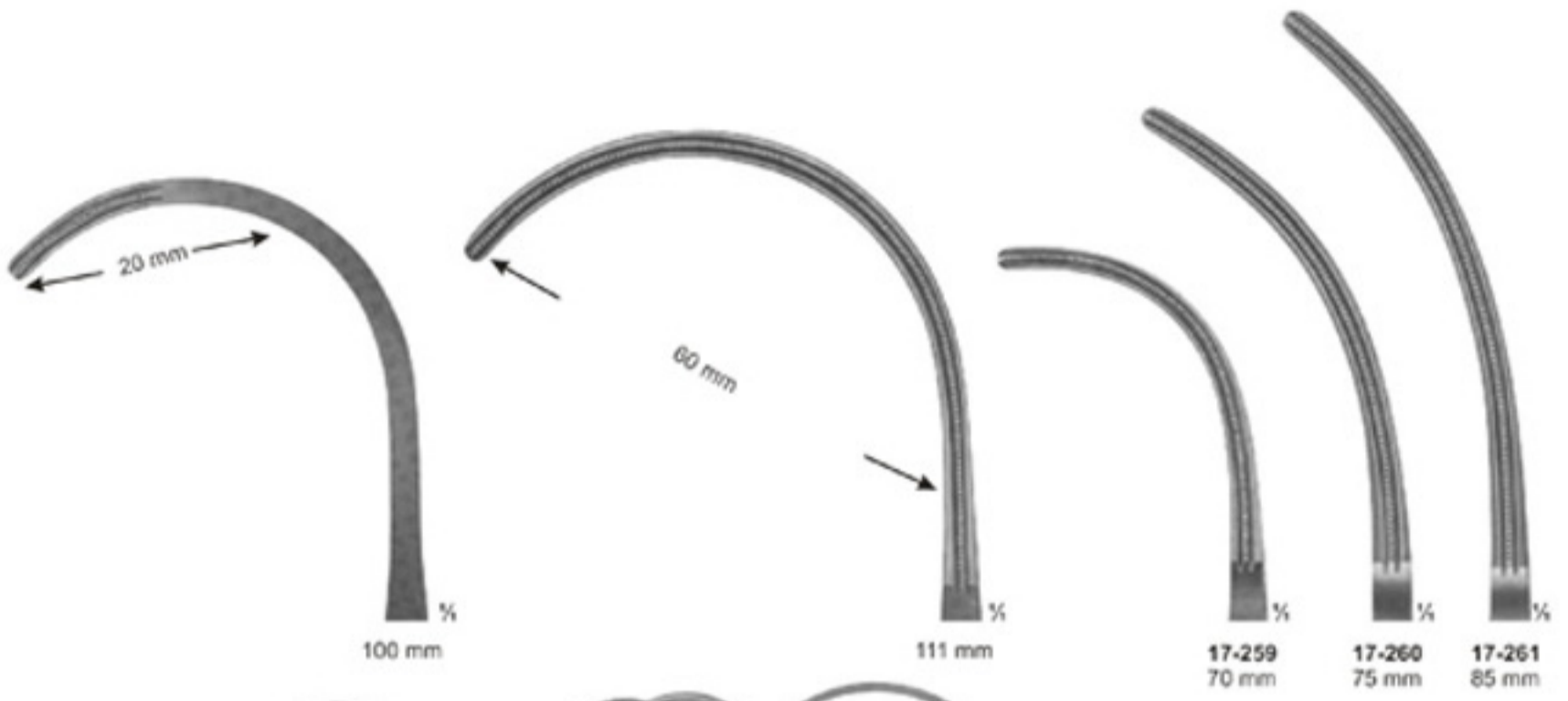



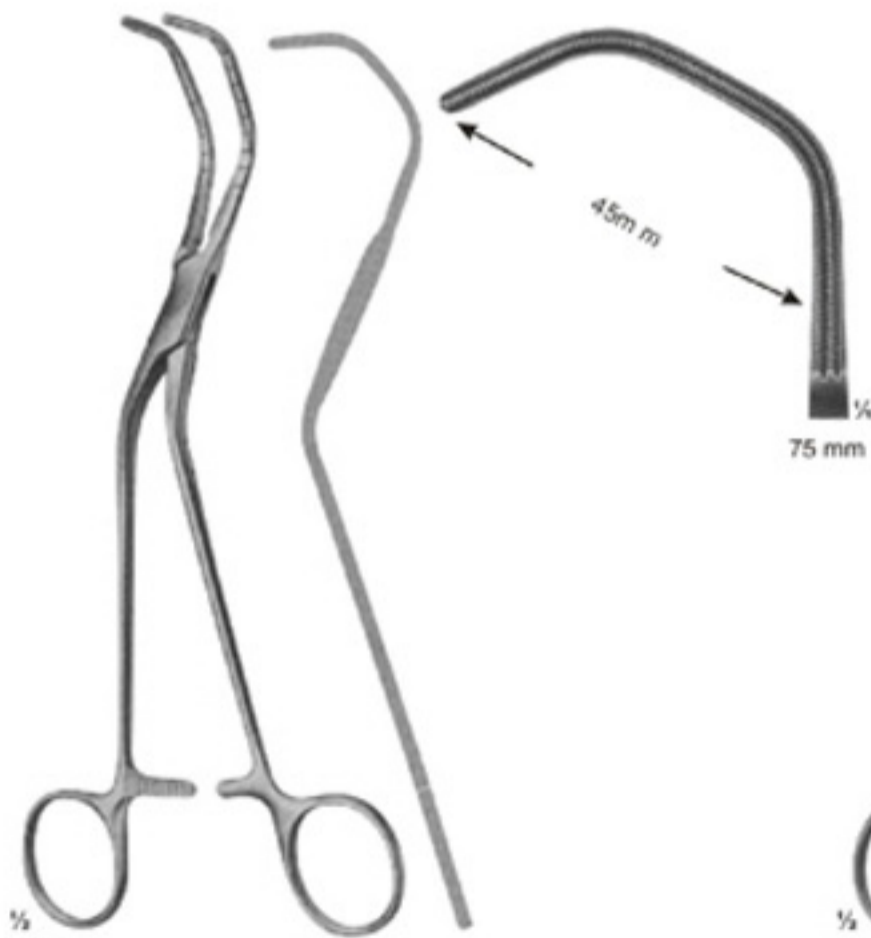

**17-267
DIETRICH**
210 mm

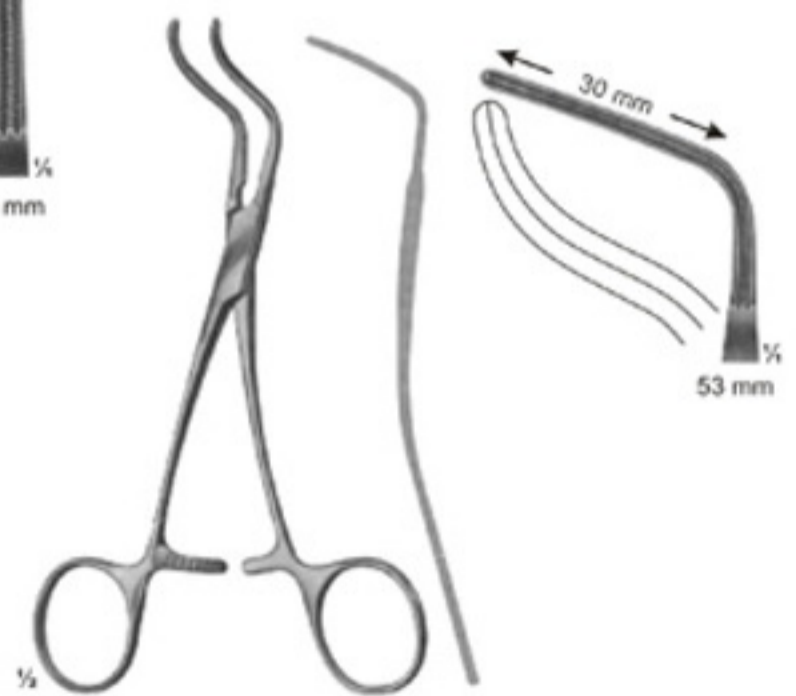

**17-268
SUBRAMANIAN**
155 mm

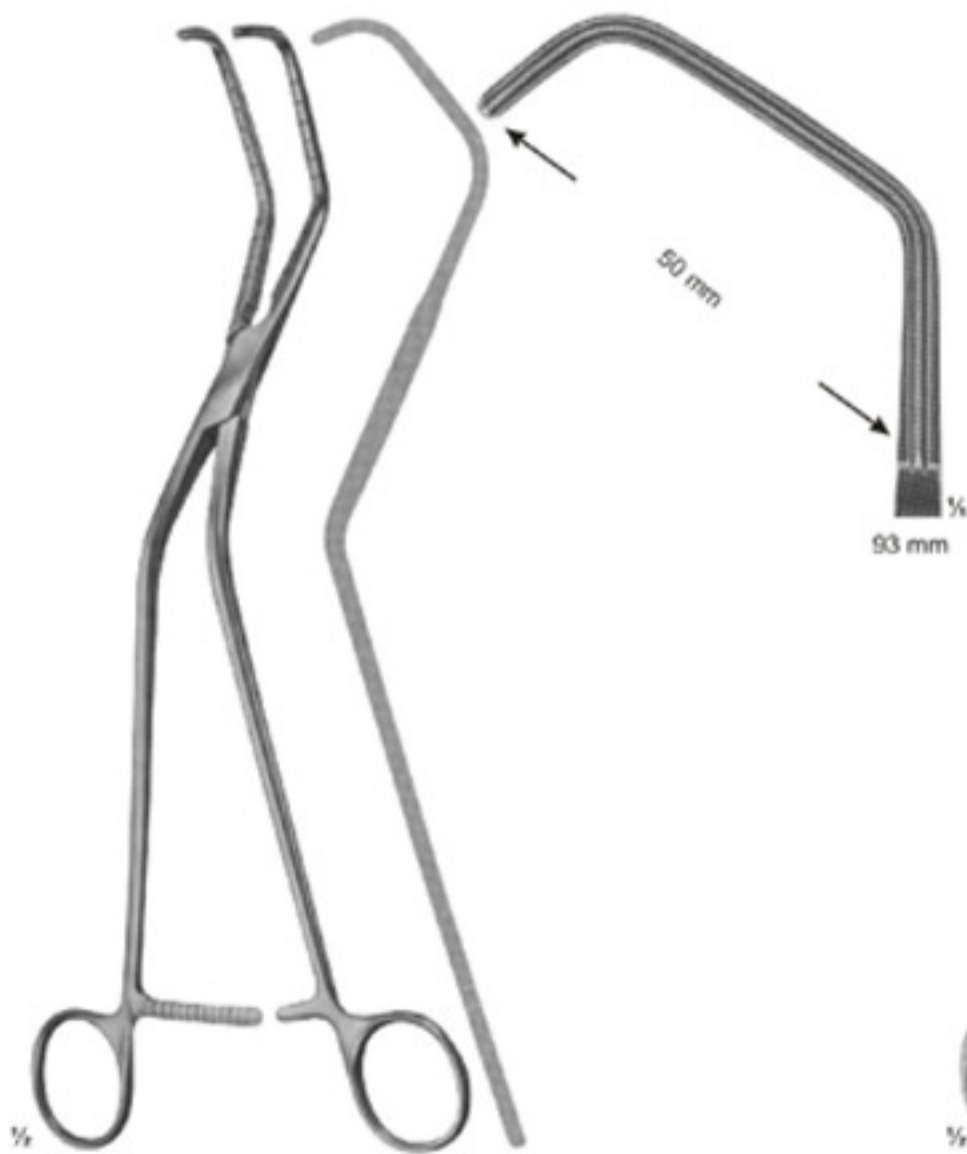

17-269
OCHSNER
260 mm

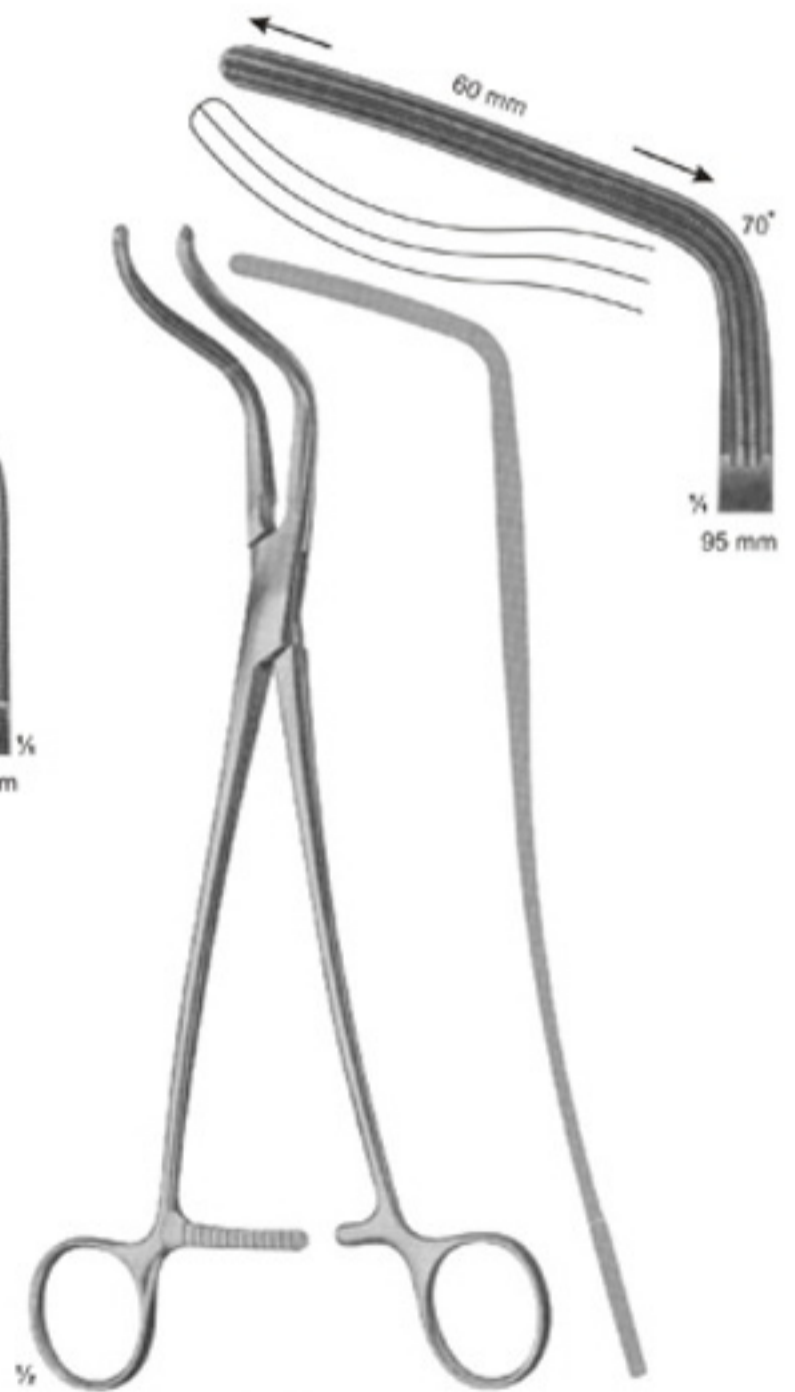

17-270
DE BAKEY
265 mm



L
17-271
WEBER
265 mm

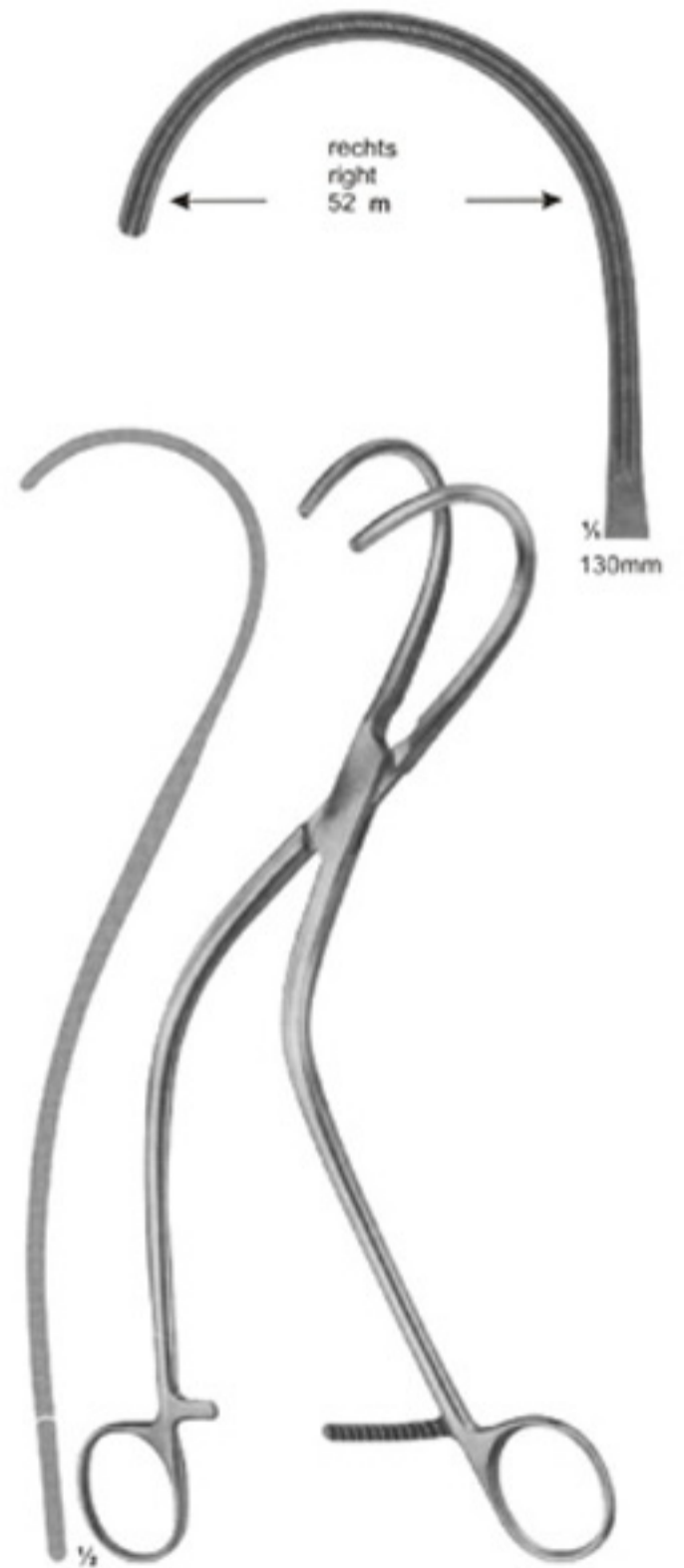

R
17-272
WEBER
265 mm

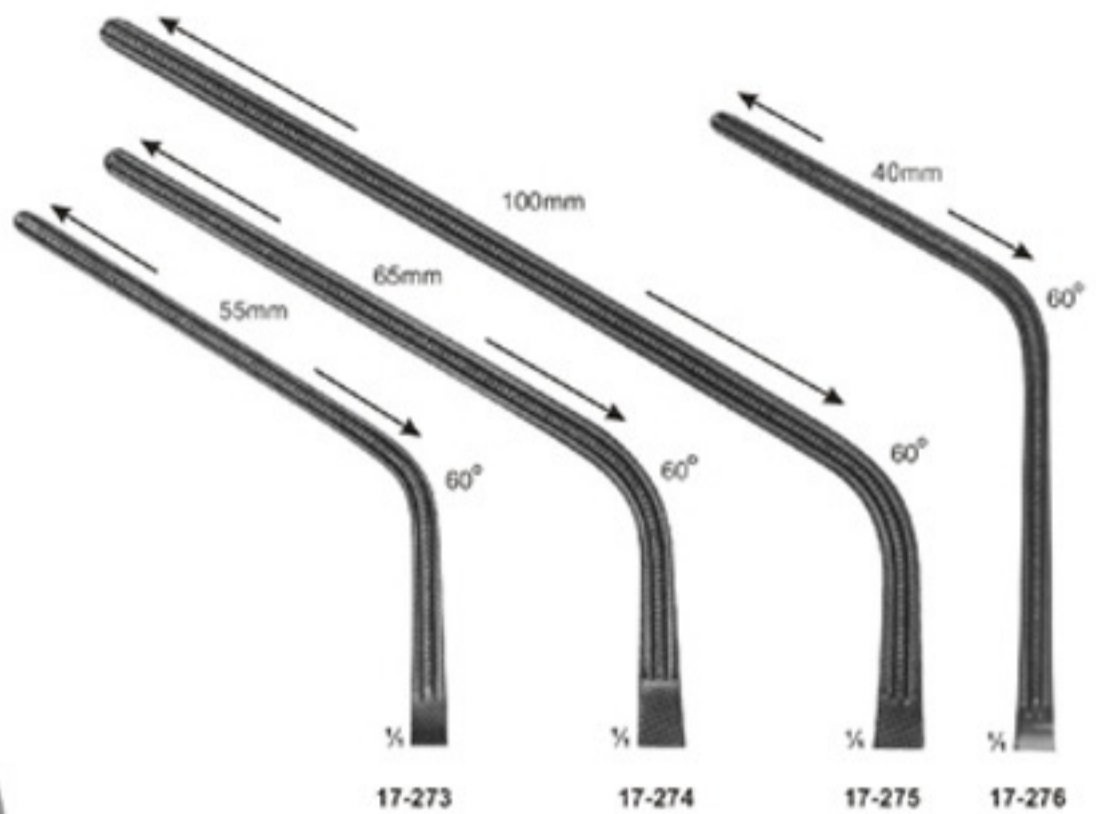

Total Length:	230 mm	280 mm	305 mm	240 mm
Length of jaws:	85 mm	100 mm	135 mm	93 mm

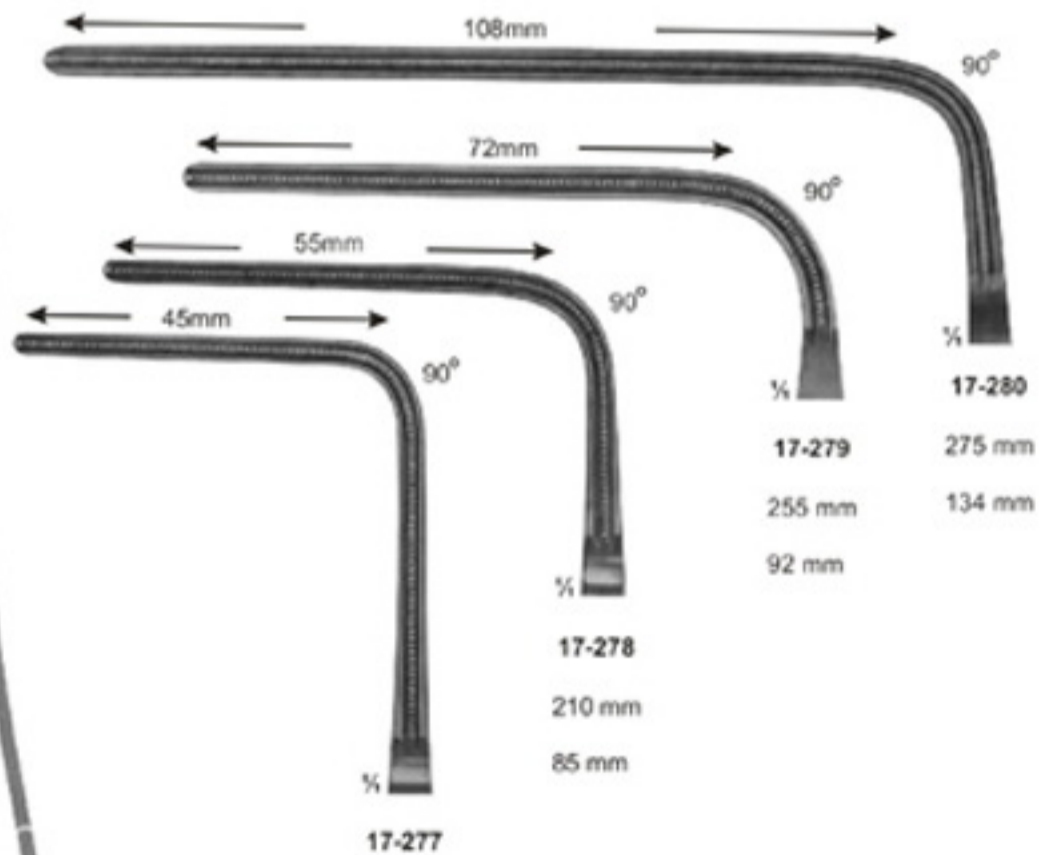

Total Length:	225 mm
Length of jaws:	93 mm



17-281
50mm



17-282
50mm

17-281 - 282
COOLEY
125 mm, 115 mm



17-283
COOLEY
100 mm

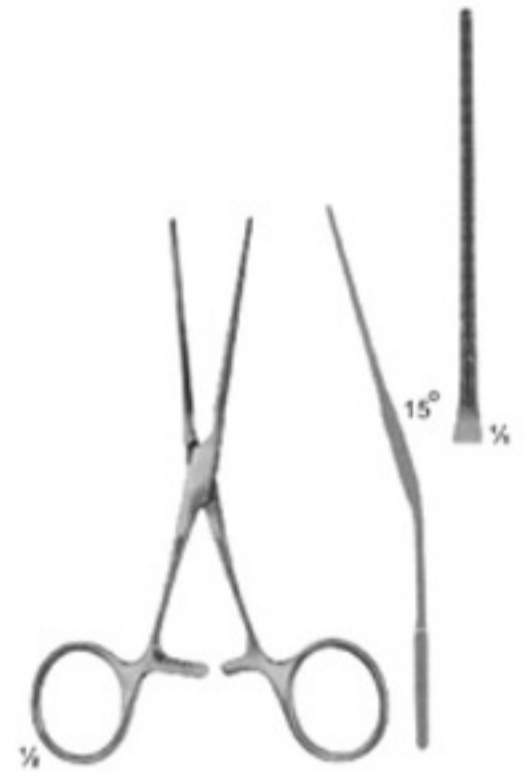

17-284
COOLEY
125 mm



17-285 - 286
COOLEY
120 mm, 115 mm

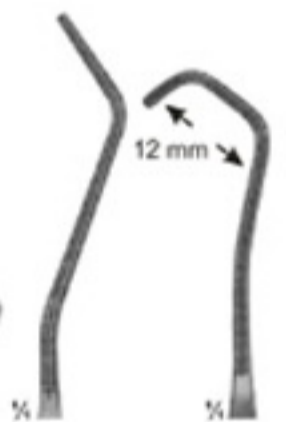

17-285
50 mm

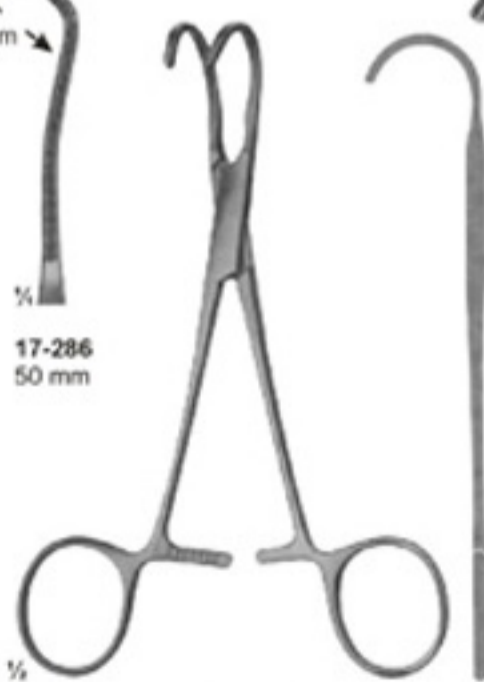

17-287 - 288
COOLEY-BACK
150 mm, 115 mm

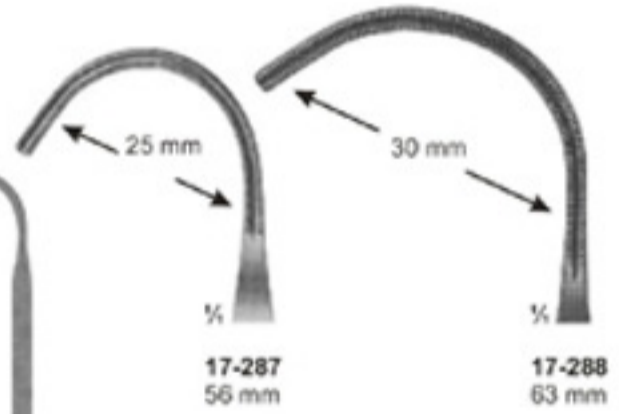

17-287
56 mm

17-288
63 mm

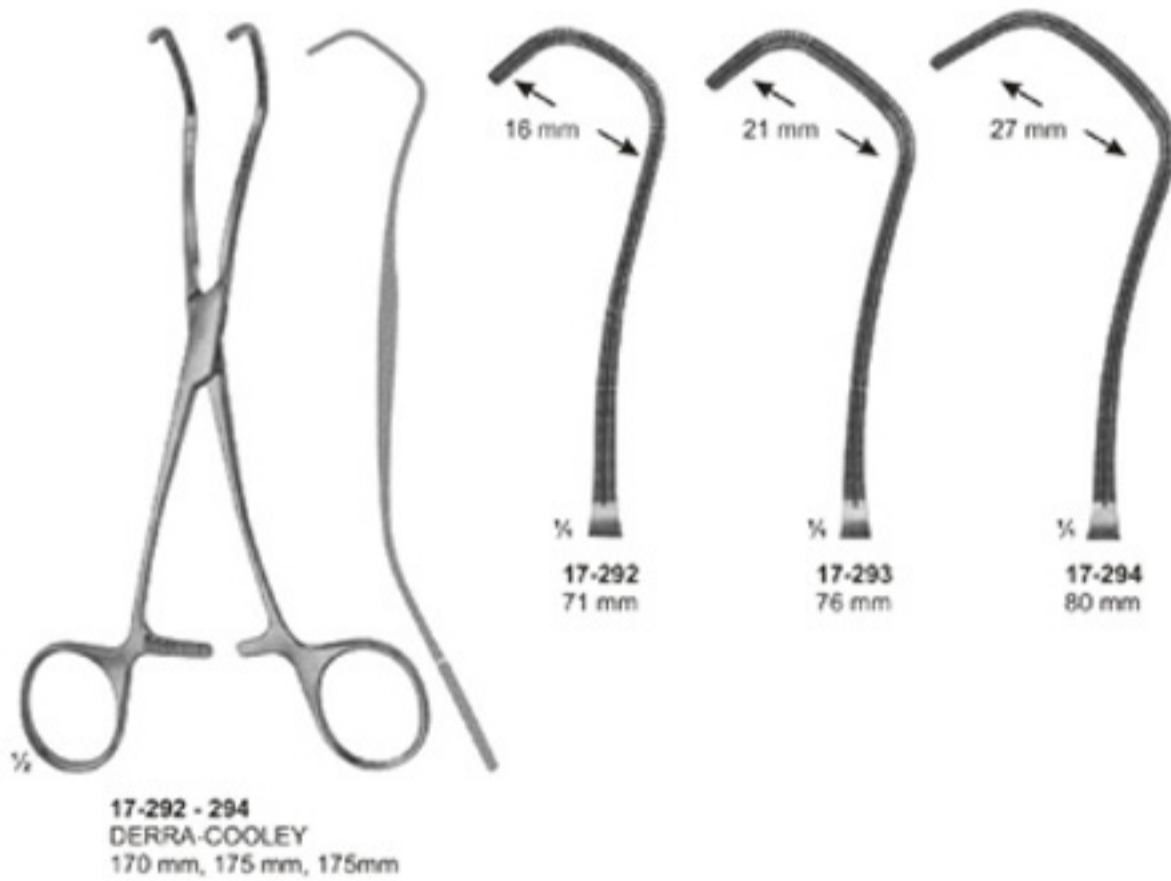
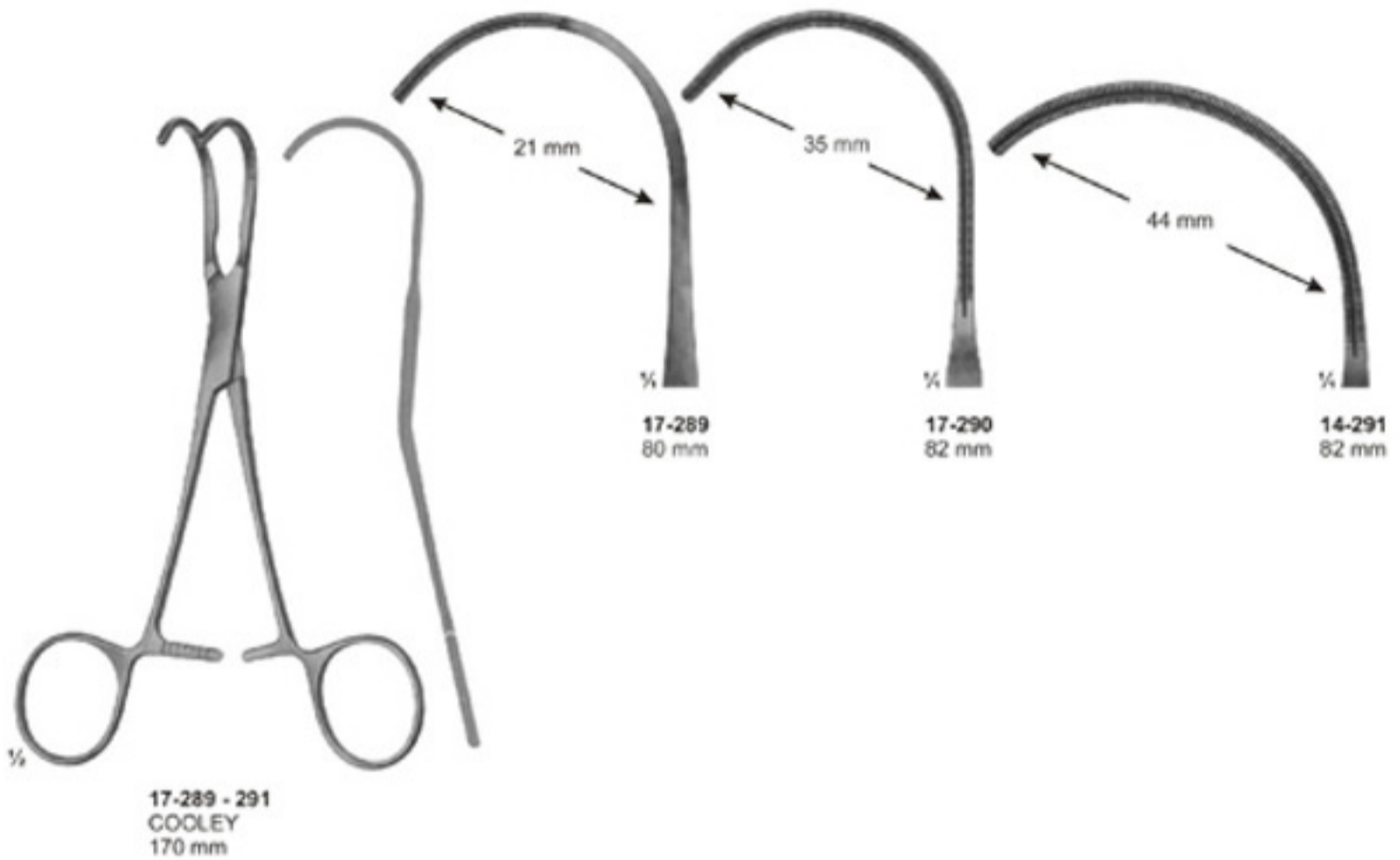

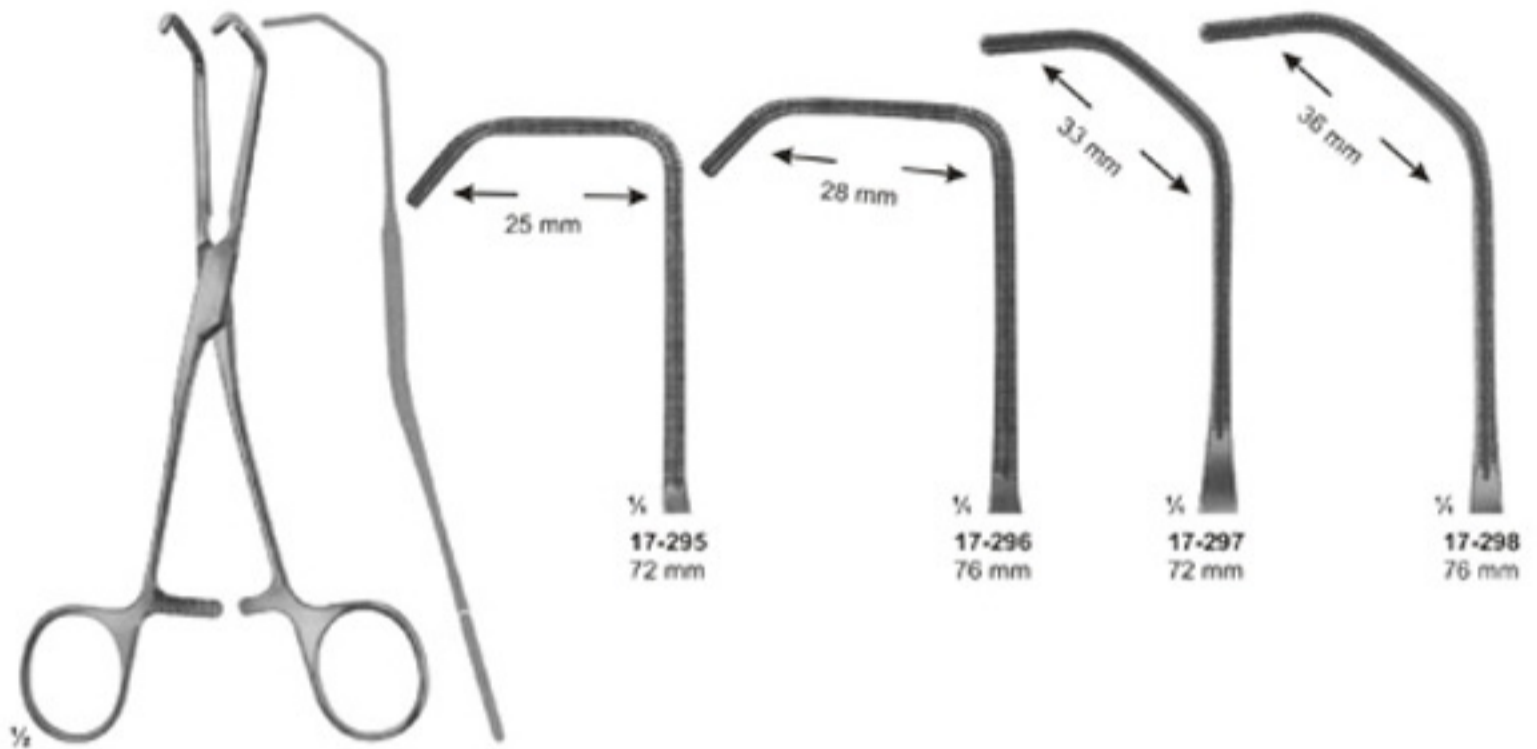

17-295 - 298
COOLEY
165 mm, 165 mm
175 mm, 180 mm

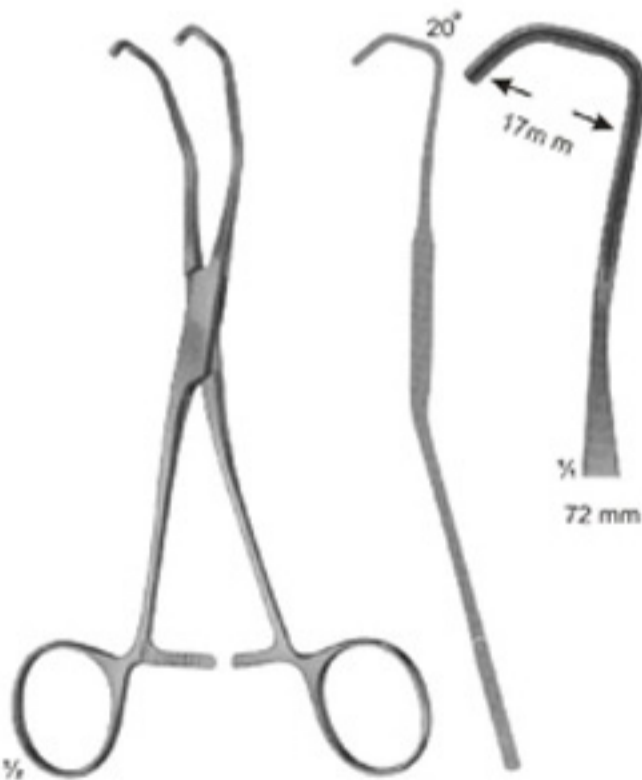

17-299
COOLEY
170 mm

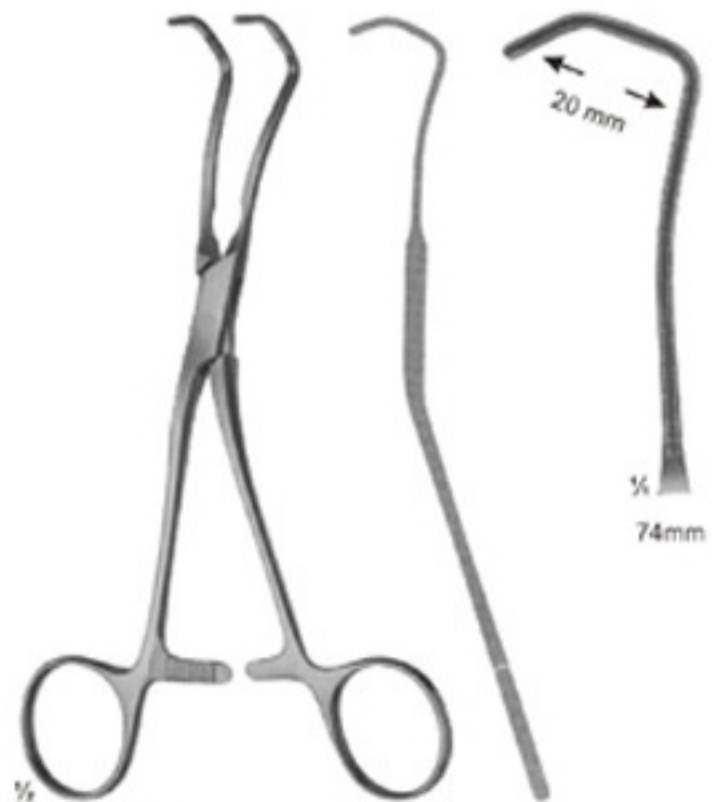

17-300
COOLEY
175 mm

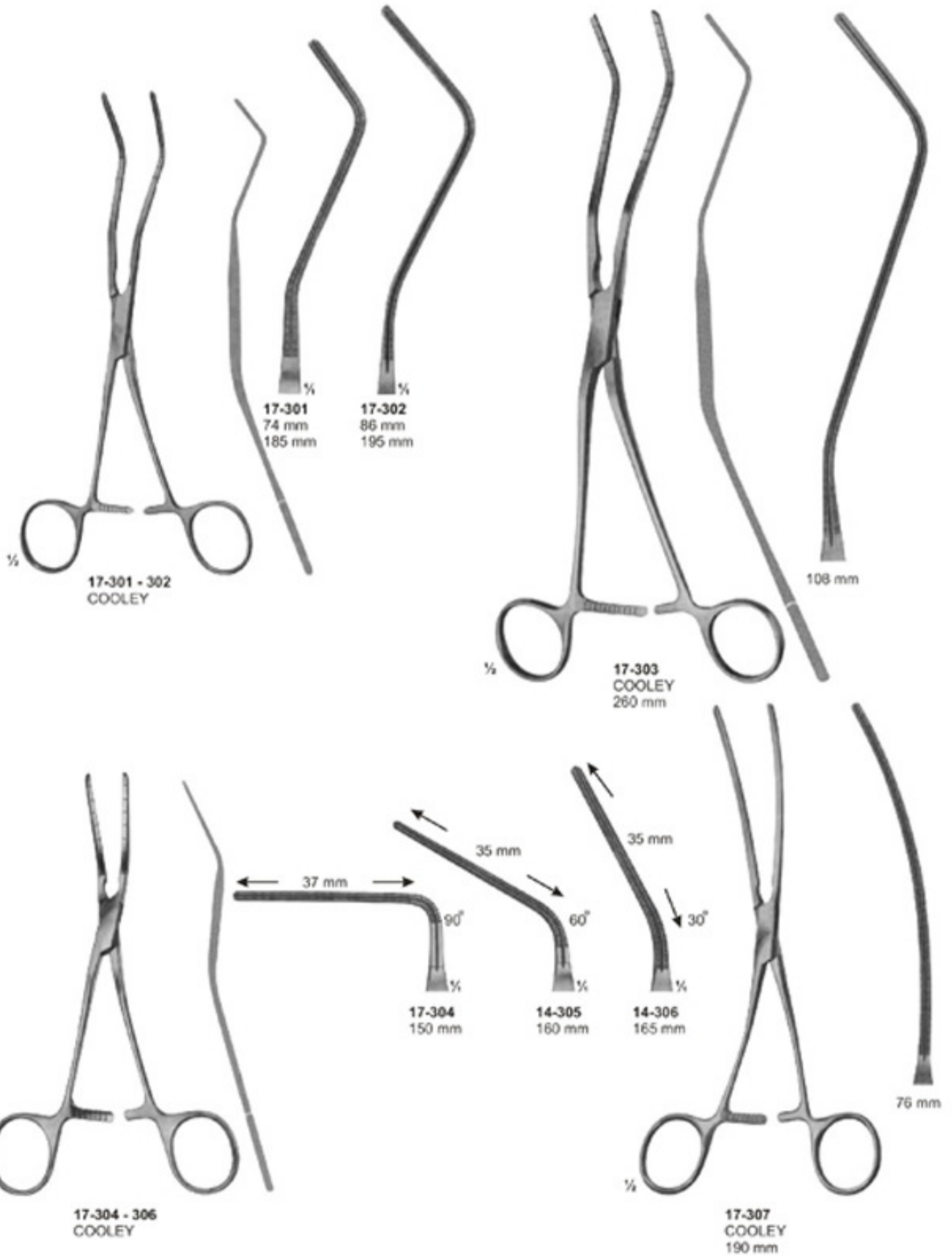

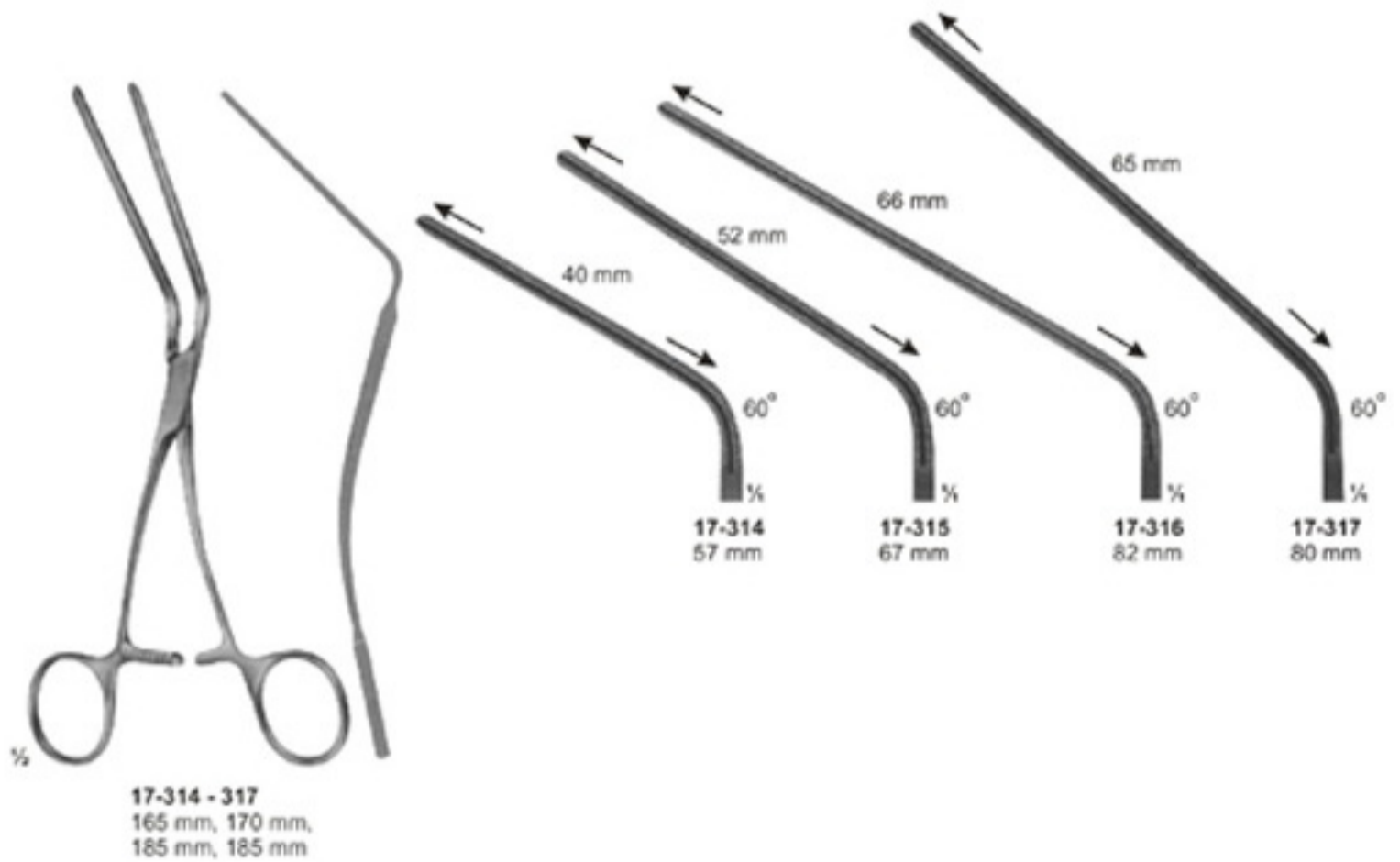
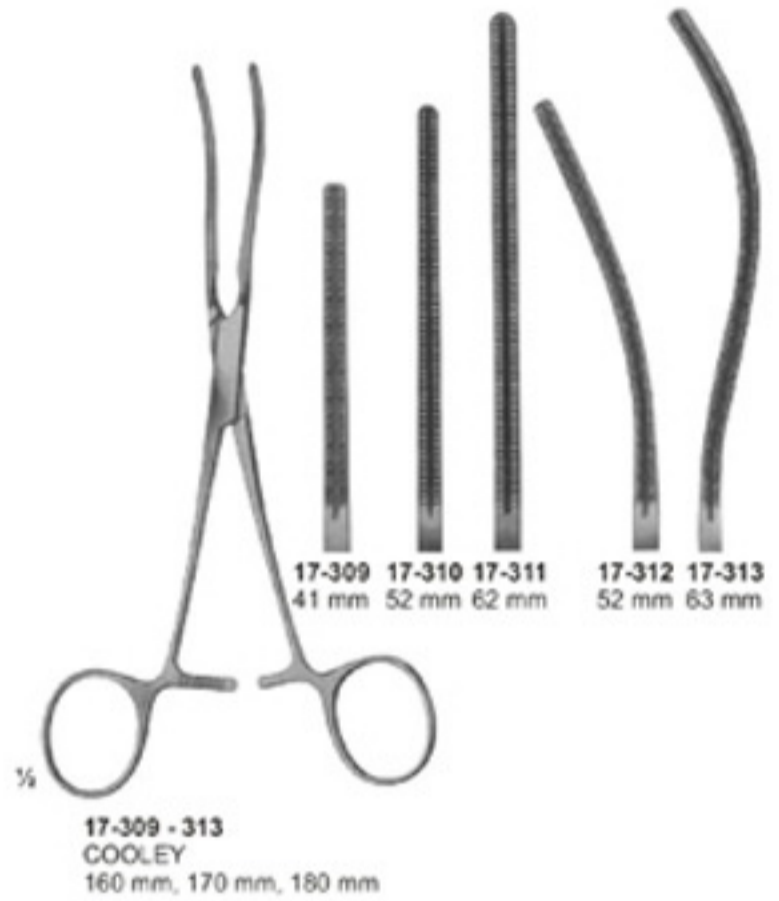
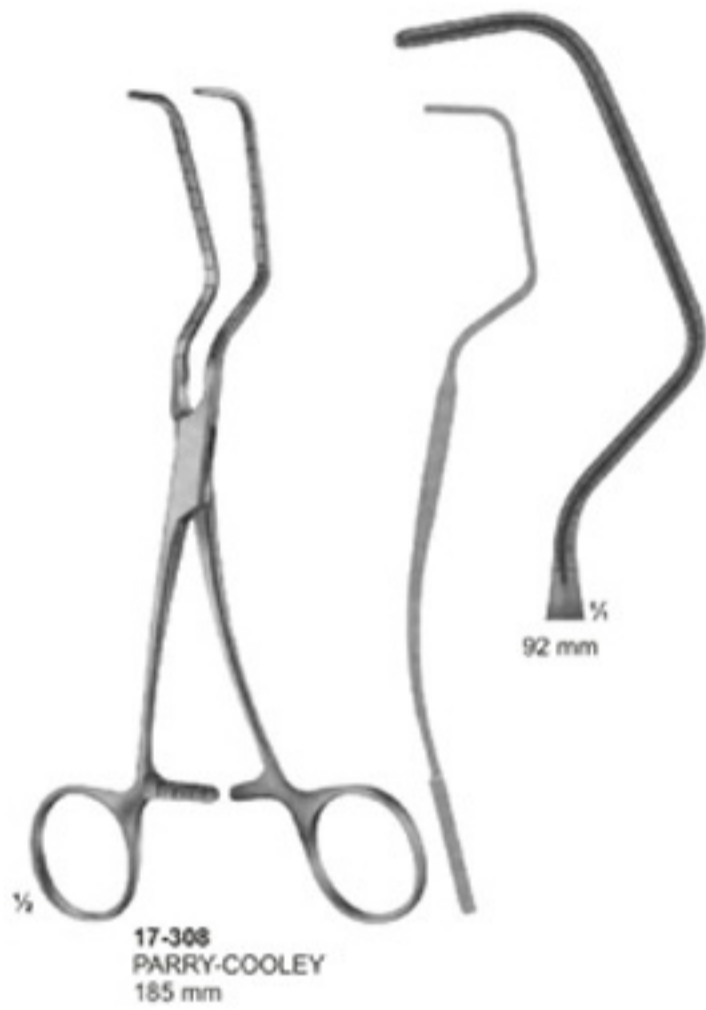



DARDIK			
17-318	150 mm	17-323	170 mm
17-319	150 mm	17-324	170 mm
17-320	150 mm	17-325	170 mm
17-321	145 mm	17-326	160 mm
17-322	130 mm	17-327	135 mm

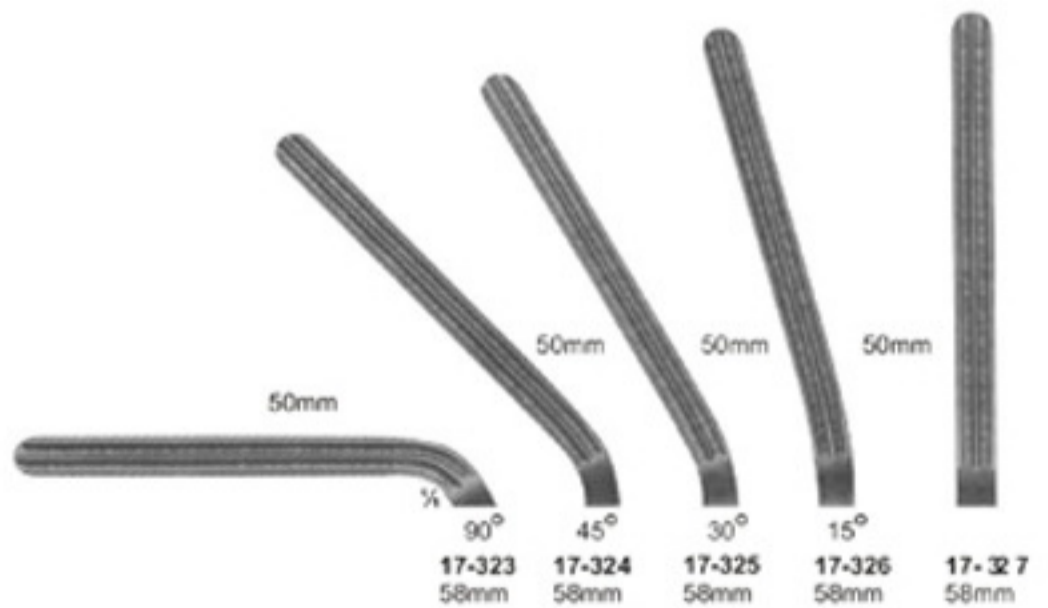
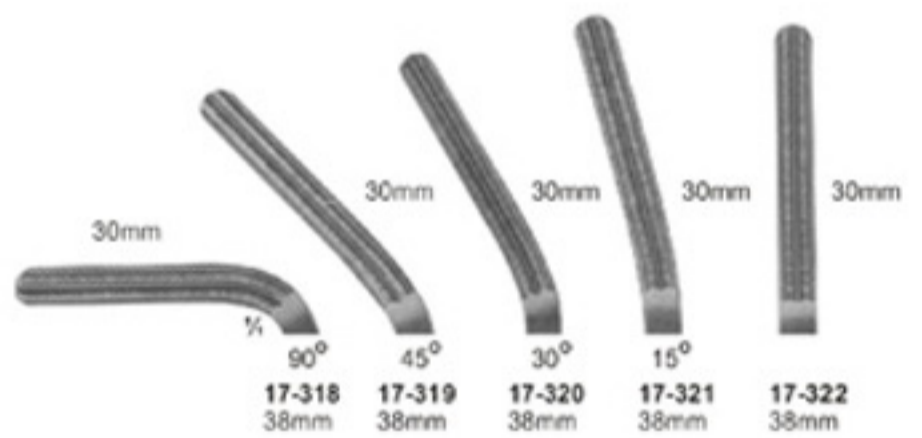



17-328
WILLIAMS
160 mm



17-329
TUTTLE
230 mm



17-330
NELSON
230 mm



17-331
DUVAL
230 mm



BABCOCK
17-332 170 mm
17-333 215 mm
17-334 220 mm



17-335
ALLIS
220 mm



17-336
FINOCHIETTO
245 mm



17-337 - 338
SEMB
244 mm

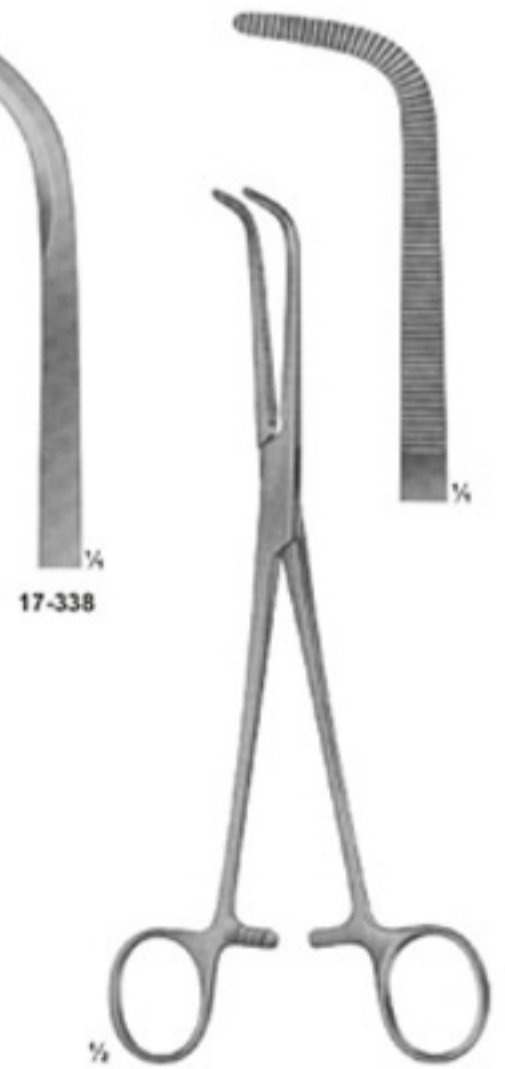

17-339
WIKSTROEM
205 mm



17-340
MIXTER
230 mm



17-341 **17-342**
220 mm 250 mm

17-341 - 342
MIXTER

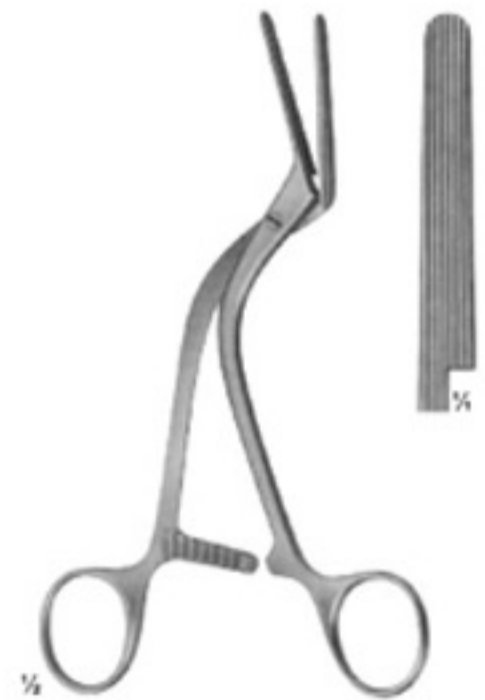

17-343
HOPFNER
160 mm



17-344
SATINSKY
265 mm



17-345
SATINSKY
265 mm



17-346
HARKEN
240 mm



17-347
PERTUISET
Carotid Clamp
90 mm



17-348
CRAFOORD-SELLORS
240 mm

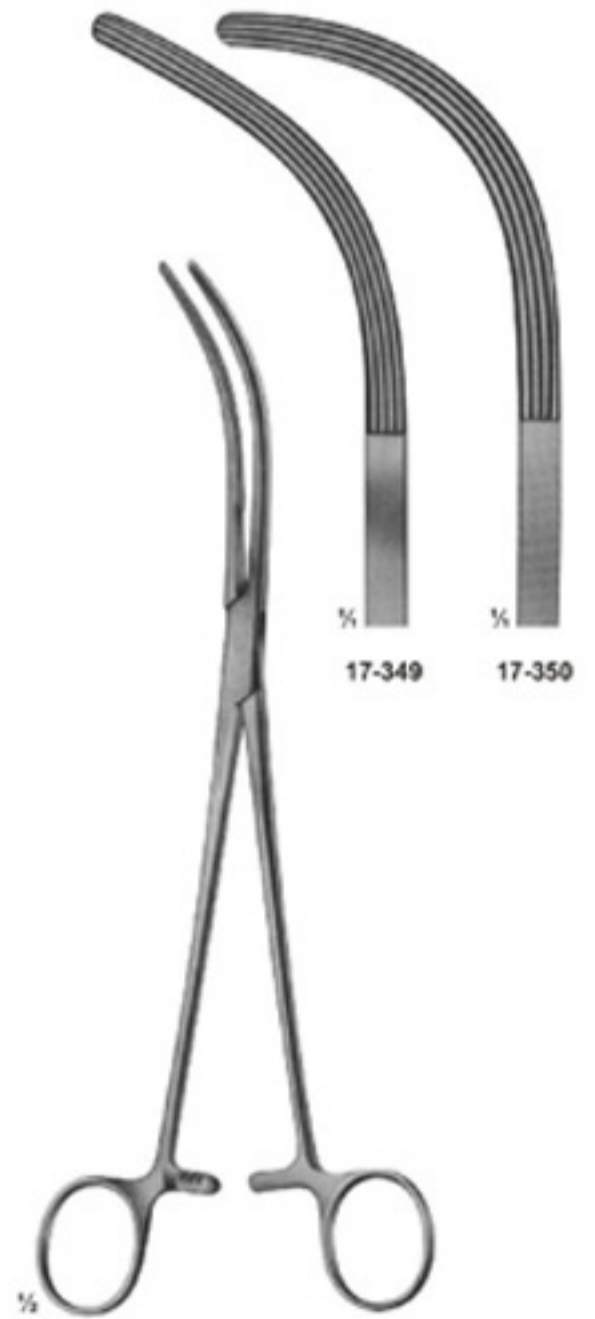

17-349 - 350
CRAFOORD
240 mm



17-351
PRICE THOMAS
225 mm



17-352
jaws with pins

17-353
jaws with pins

17-352 - 353
PRICE THOMAS
225 mm



17-354
SCHUMACHER
Sternum shears
210 mm



17-355
LEBSCHKE
Sternum chisel
200 mm



17-356
230 mm



17-357
COLLIN
195 mm



17-358
GLUCK
190 mm



17-359
GLUCK
190 mm



17-360
BRUNNER
Universal Pattern
340 mm



17-361
GIERTZ-STILLE
250 mm



17-362
SEMB
Rib-and Bone
Holding forceps
190 mm



17-363
SEMB
Rib-and Bone
Holding forceps
190 mm



17-364
LISTON-STILLE
265 mm

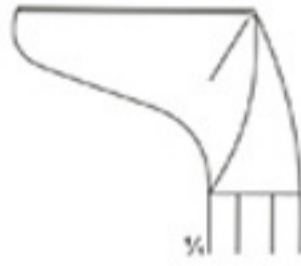

17-365
LISTON-KEY-HORSLEY
255 mm



17-367



17-368



17-366
SEME
Rib Rongeur to shorten
the rib stumps
240 mm



17-367-368
SAUERDRUCH-CORYLLOS
Rib rongeurs to shorten
the rib stumps
310 mm

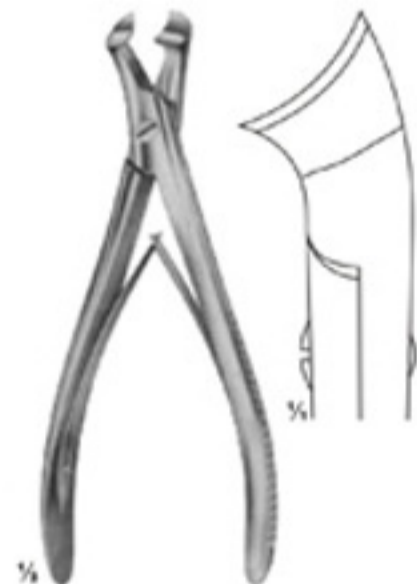

17-369
MARKWALDER
Rib Rongeur to Round
the rib stumps
190 mm



17-370 - 371
DOYEN
for children
175 mm

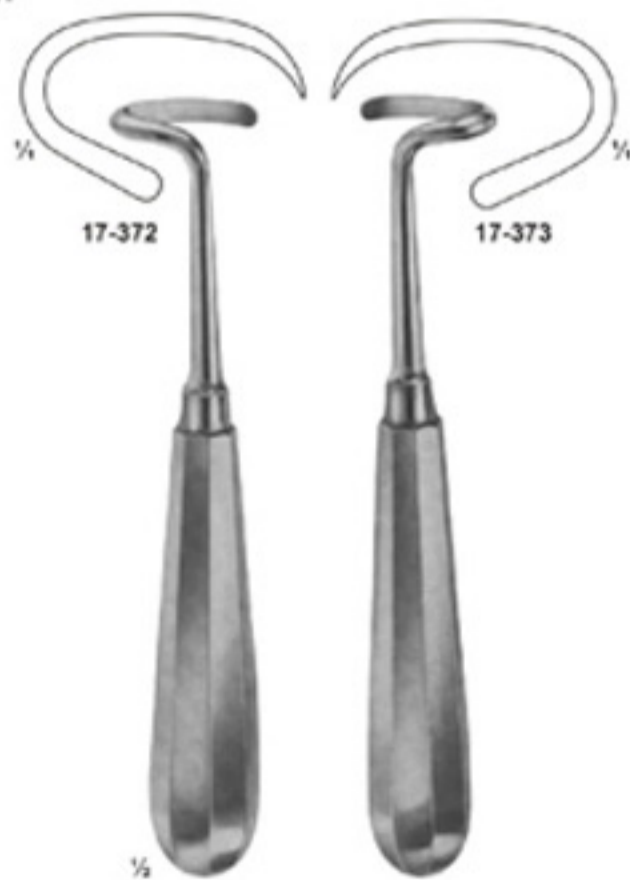

17-372 - 373
DOYEN
for adults
175 mm



17-374 - 375
DOYEN
240 mm

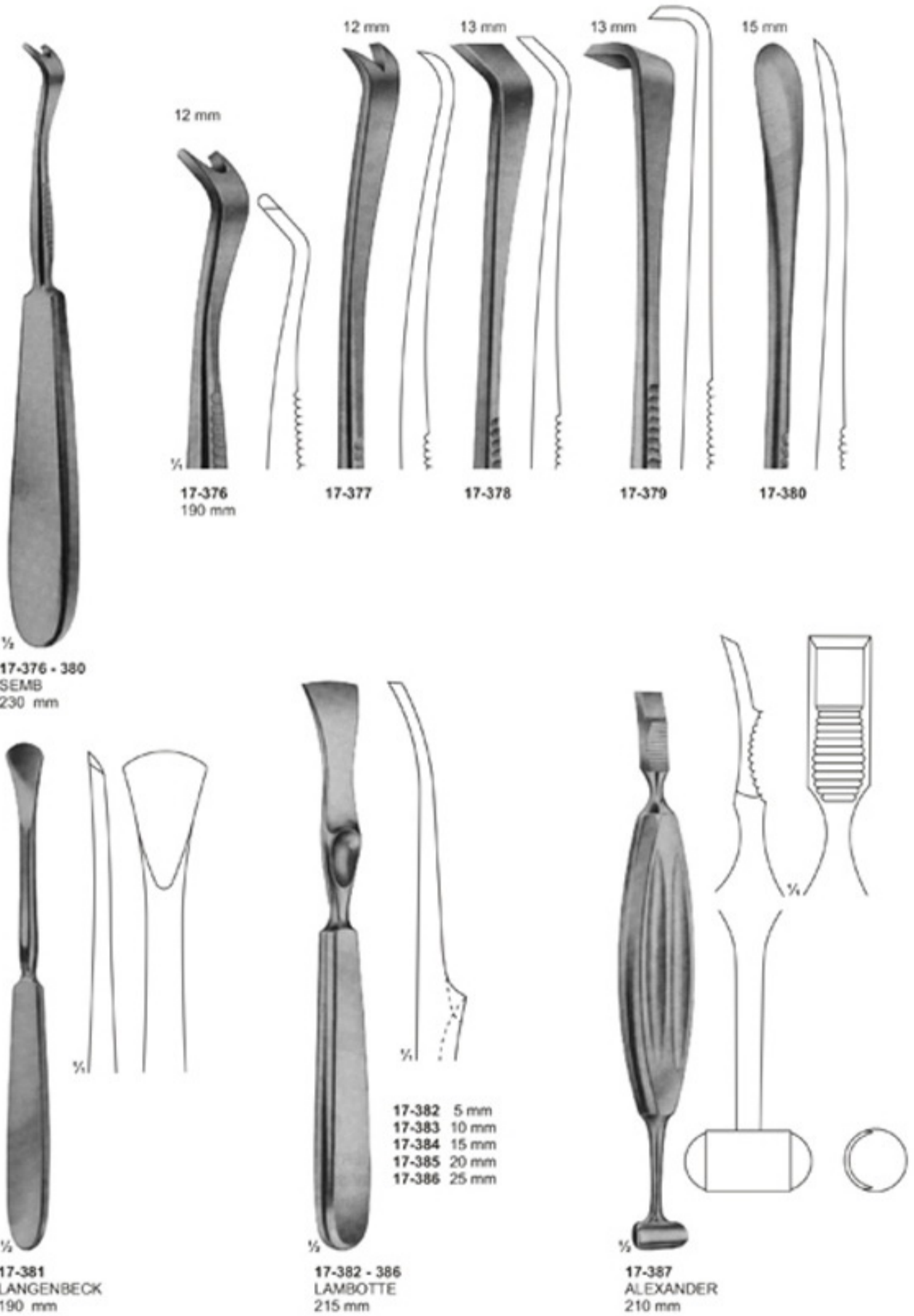

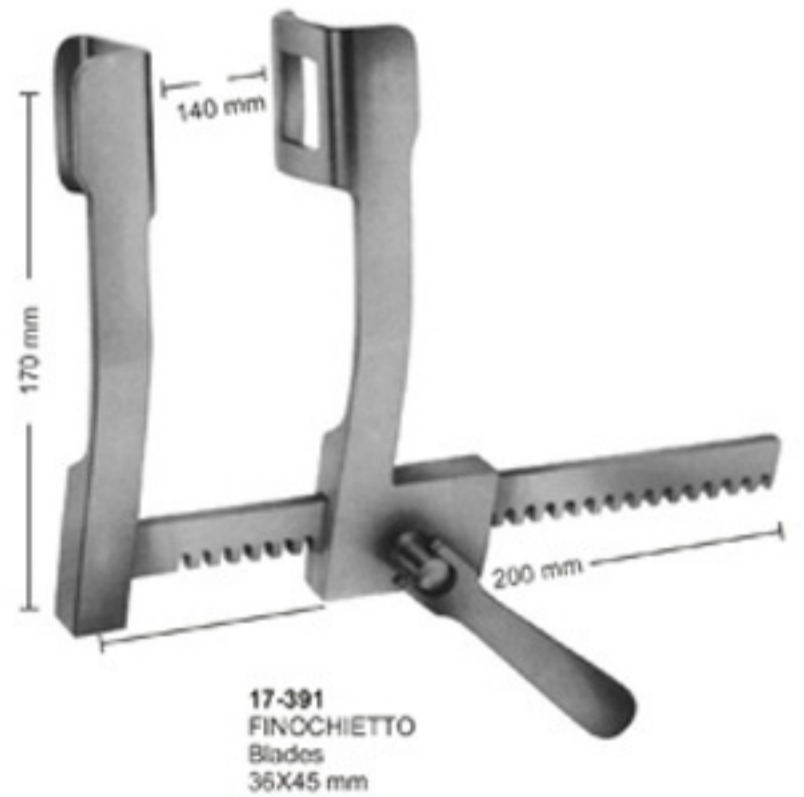
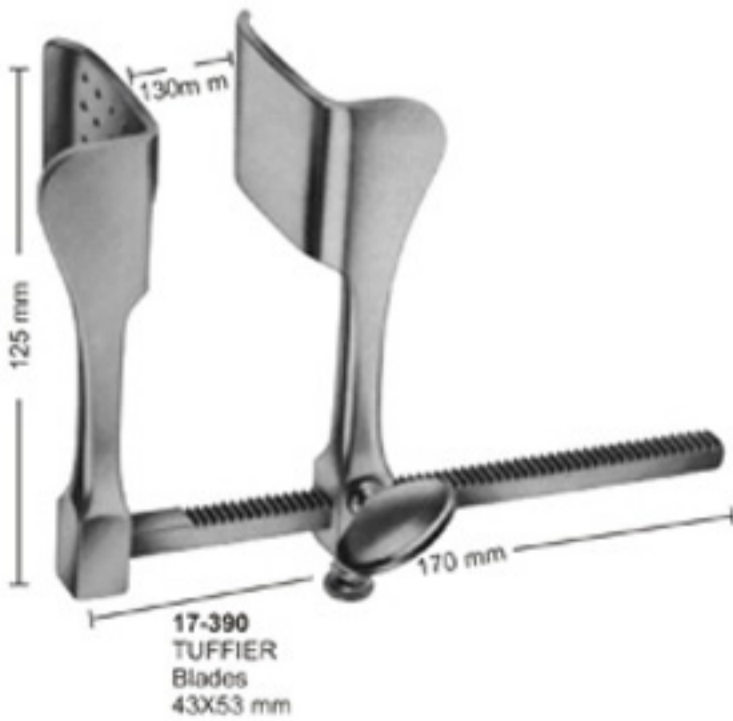
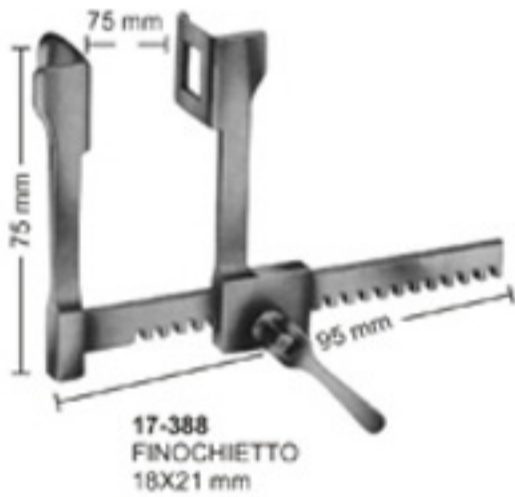

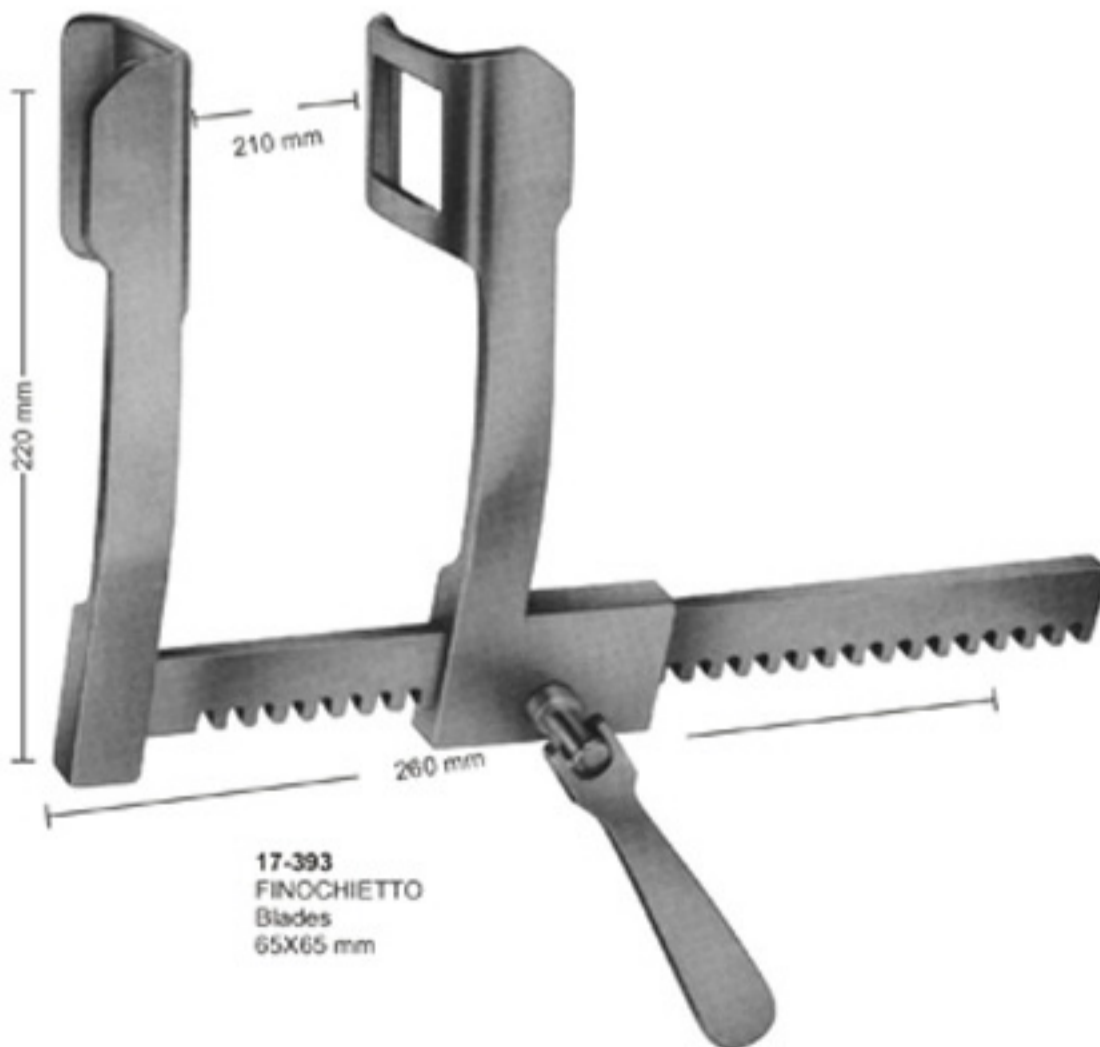
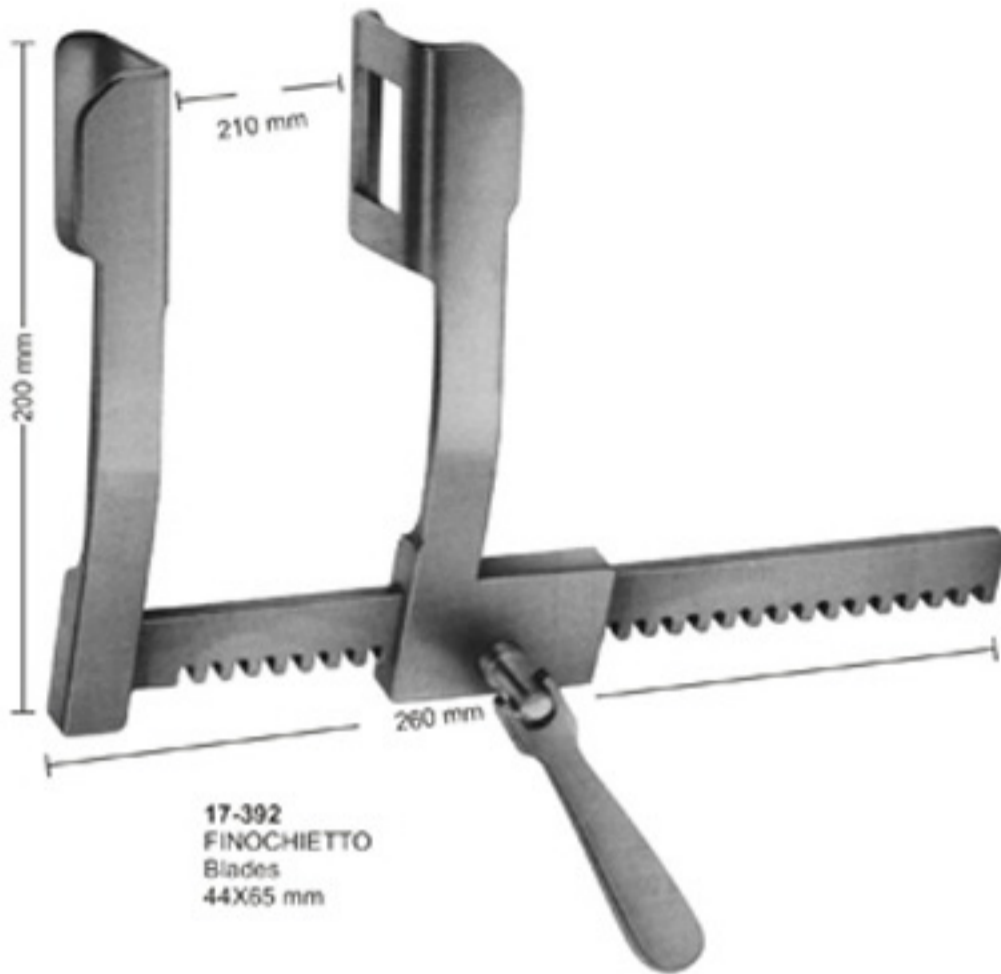

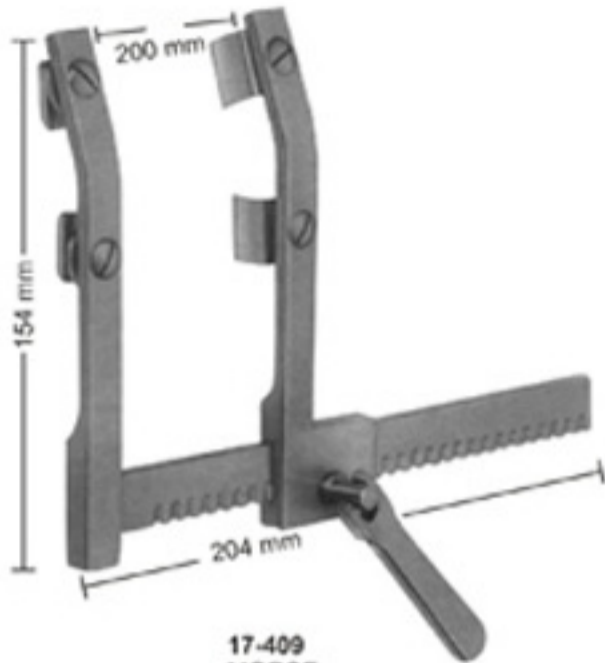

17-409
MORSE
Sternotomy spreader
for children, with moveable
double, each blade
12x20 mm

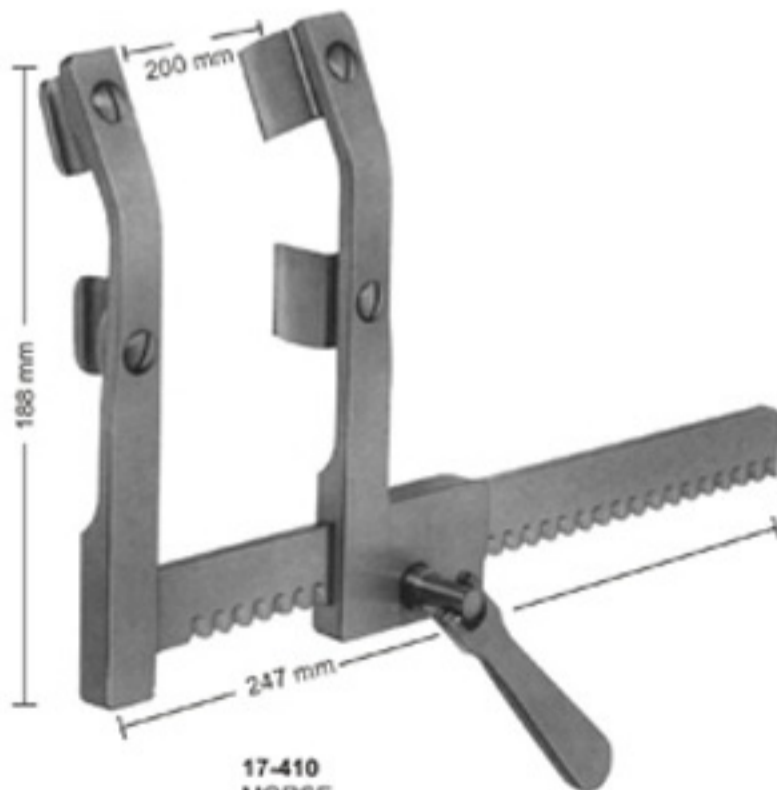

17-410
MORSE
Sternotomy spreader
for adults, with moveable
double, each blade
19x19 mm

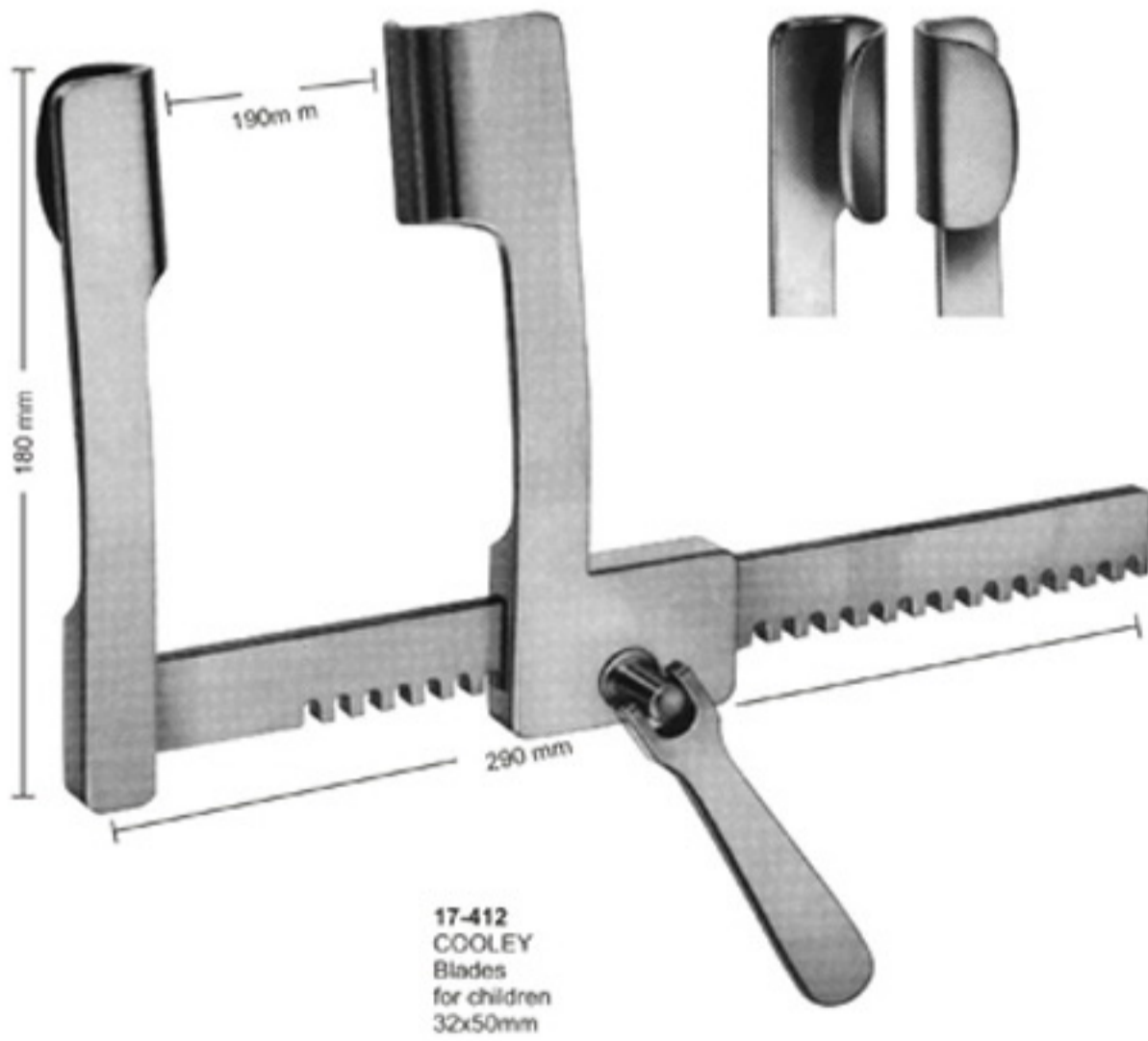
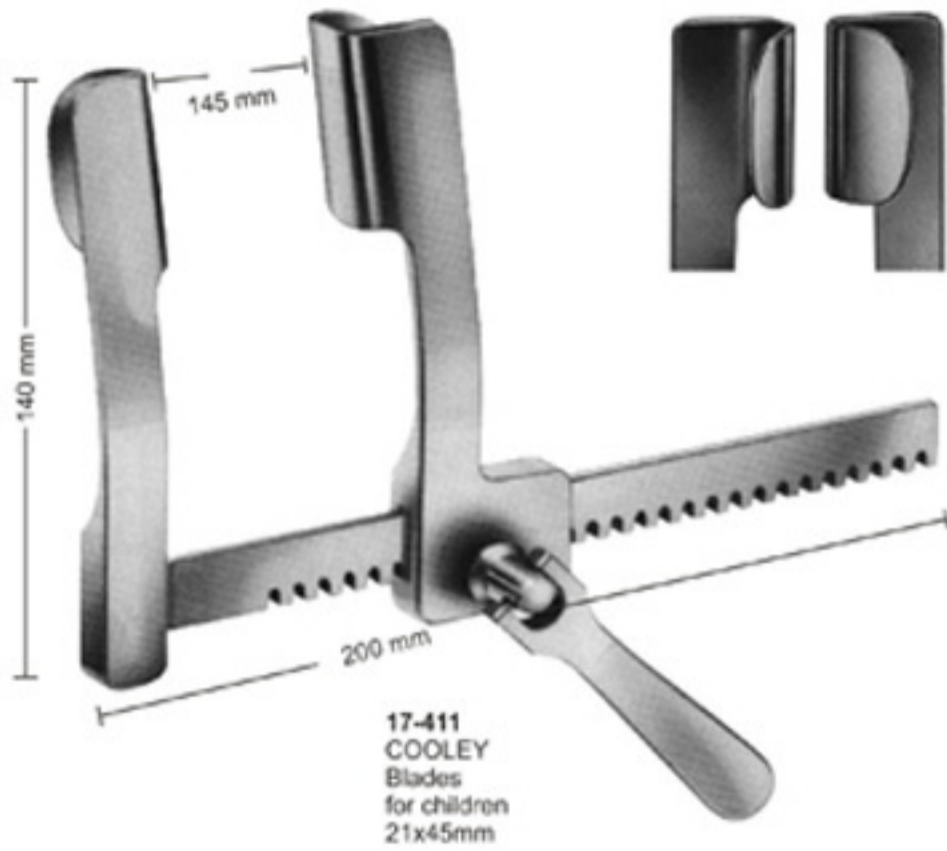



17-414
Blades
75x75 mm

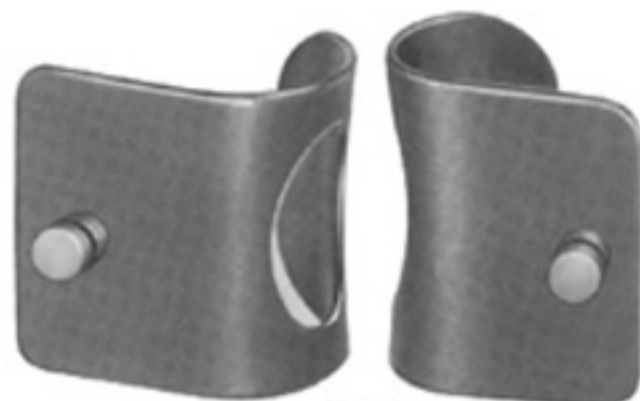

17-415
Blades
42x65 mm

Blades with Ball Snap System
Delivery: in Pairs

- 17-413 - 415**
Thoraxsperrer (Mercedes-Sperrer)
complete consisting of:
17-413 Retractor only
17-414 1 Pair of blades 42x65 mm
17-415 1 Pair of blades 75x75 mm



17-416
SELLORS
Rib spreader-and contractor
with swivel blades
200 mm



17-417
BAILEY
150 mm



17-418
for children

17-419
for children

17-418 - 419
BAILEY
200 mm

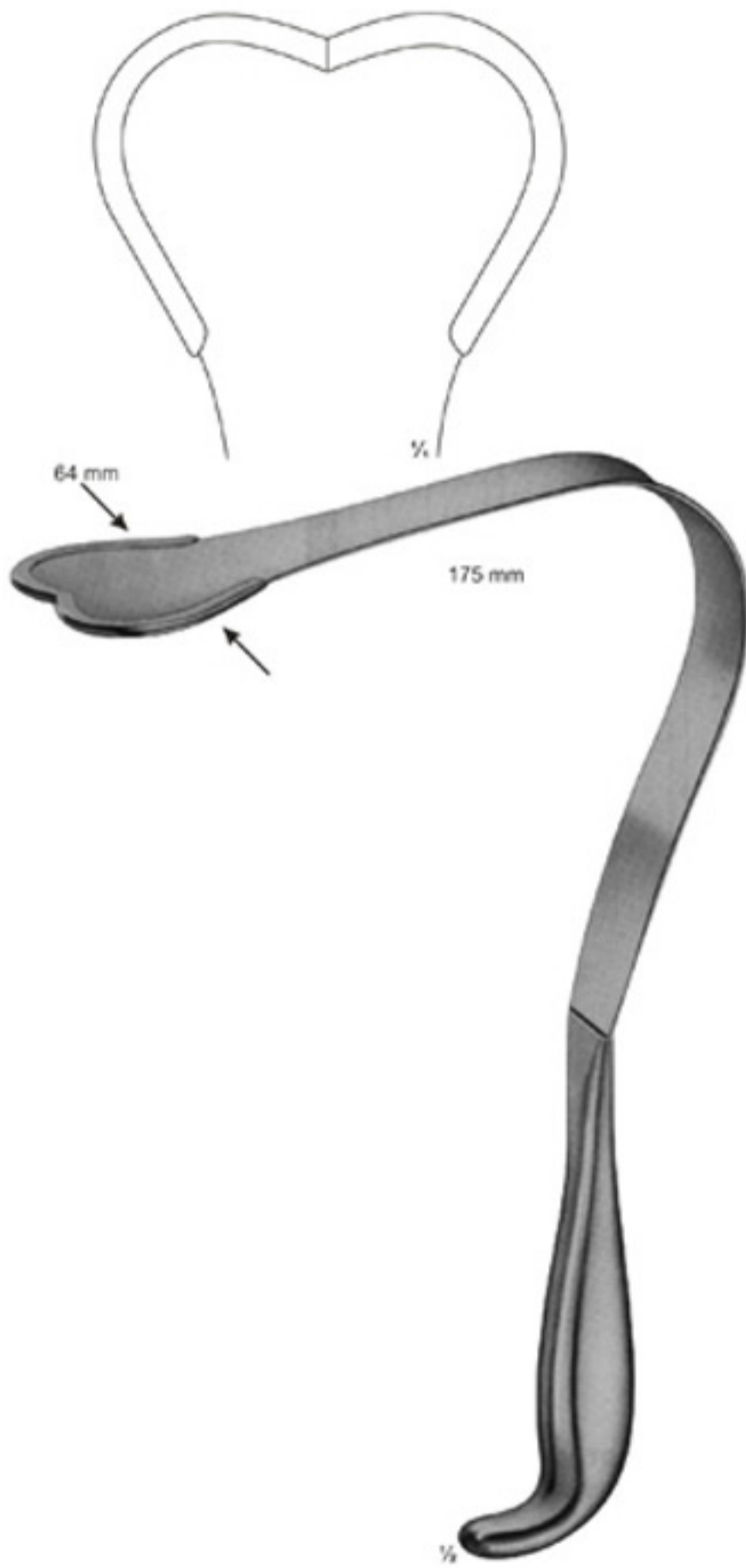

17-420
HARRINGTON-PEMBERTON
 federnd/flexible
 295 mm



17-421
DAVIDSON
 Scalpel haken



17-422
ALLISON
255 mm



17-423
ALLISON
320 mm



17-424
DE BAKKEY
With central bore,
3.0mm diam.
with lateral slots
275 mm



17-425
YANKAUER
With central bore,
2.0mm diam.
285 mm

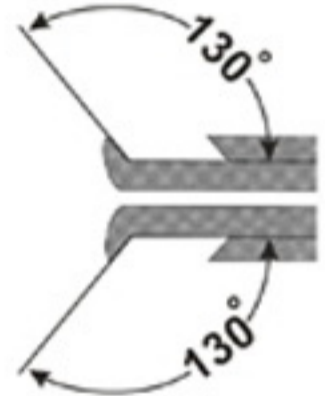
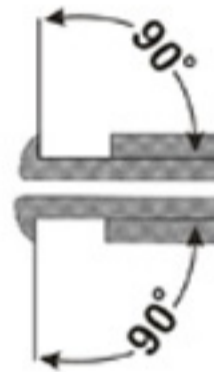
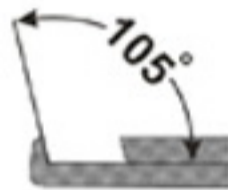

90° upwards cutting

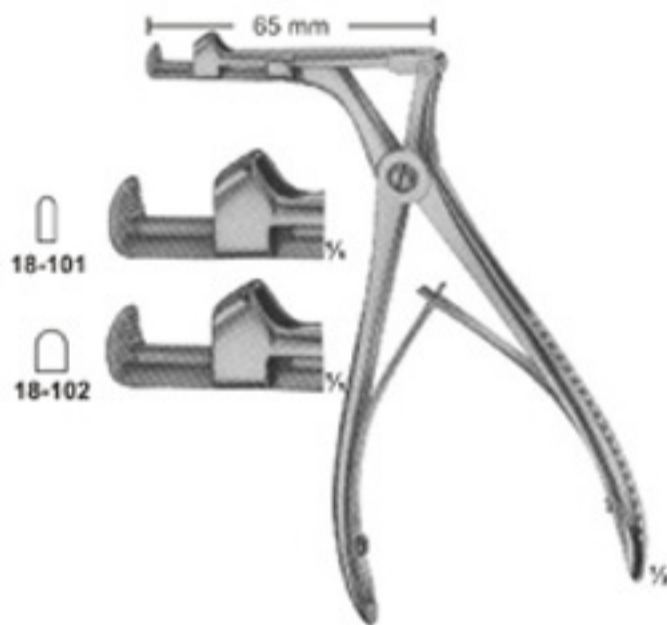

18-101

18-102

18-101 - 102
CITELLI
2 mm, 3,5 mm

90° upwards cutting

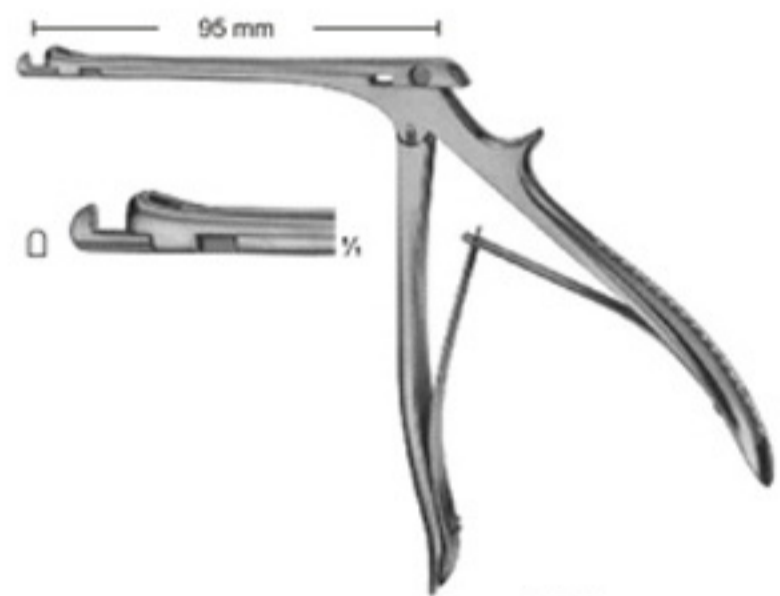

18-103
CITELLI- BEYER
1,8 mm

90° upwards cutting

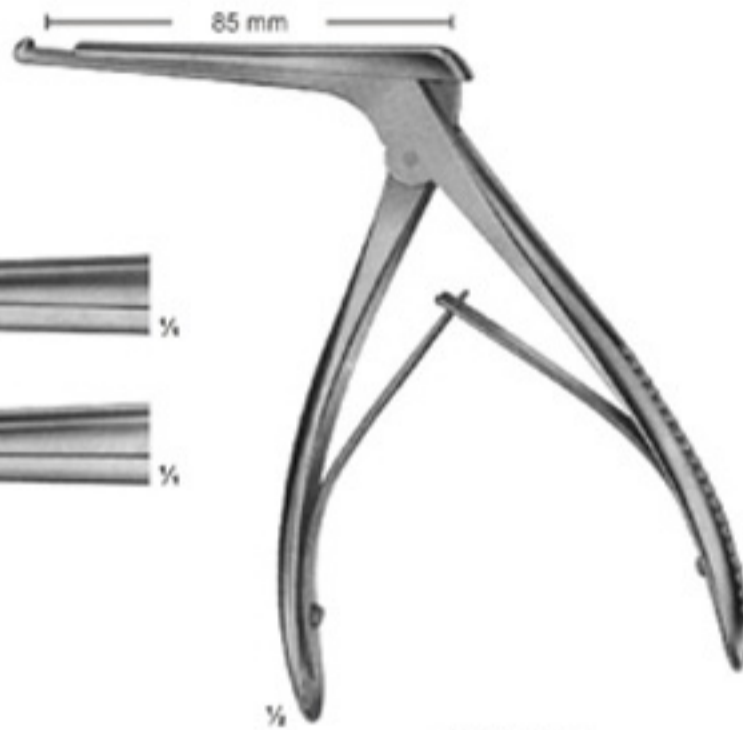

18-104
4 mm



18-105
5 mm



18-104 - 105
KERRISON

90° upwards cutting

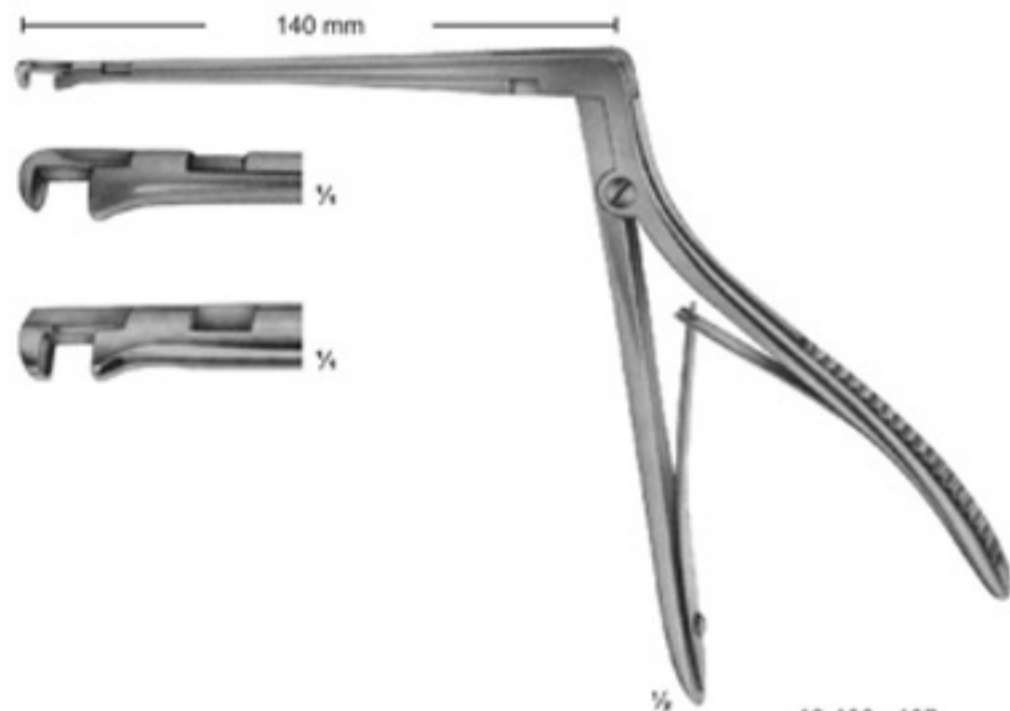

18-106
3,3 mm



18-107
4,0 mm



18-106 - 107
HAJEK-KOFLER

130° upwards cutting

18-108
1 mm



18-109
2 mm



18-110
3 mm



18-111
4 mm



18-112
5 mm

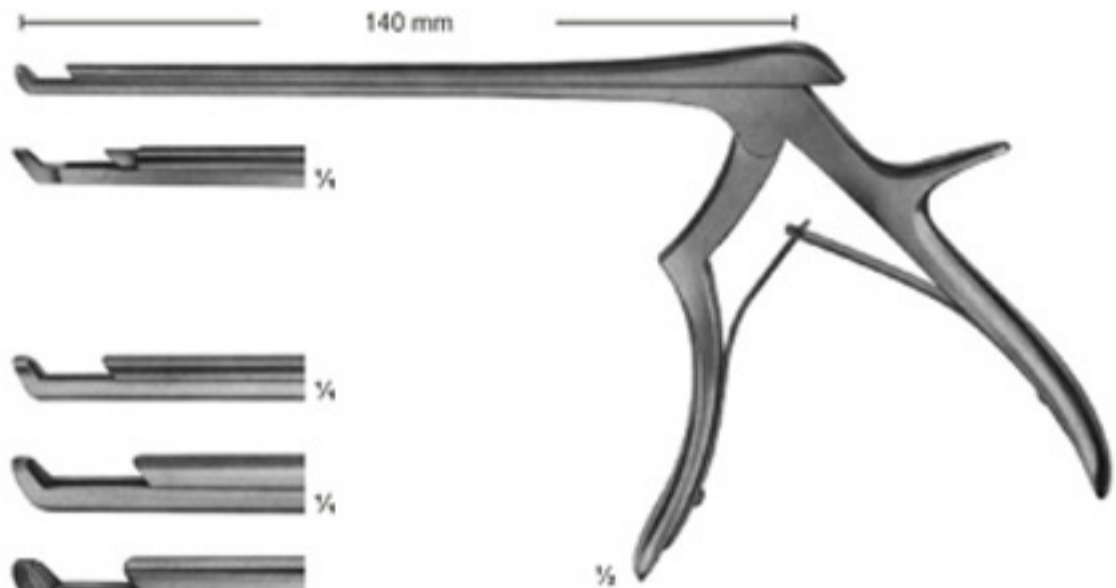

18-108 - 112
KERRISON-JACOBY

90° upwards cutting

18-113
1 mm



18-114
2 mm



FERRIS-SMITH-KERRISON

18-115
3 mm



18-116
4 mm



18-117
5 mm

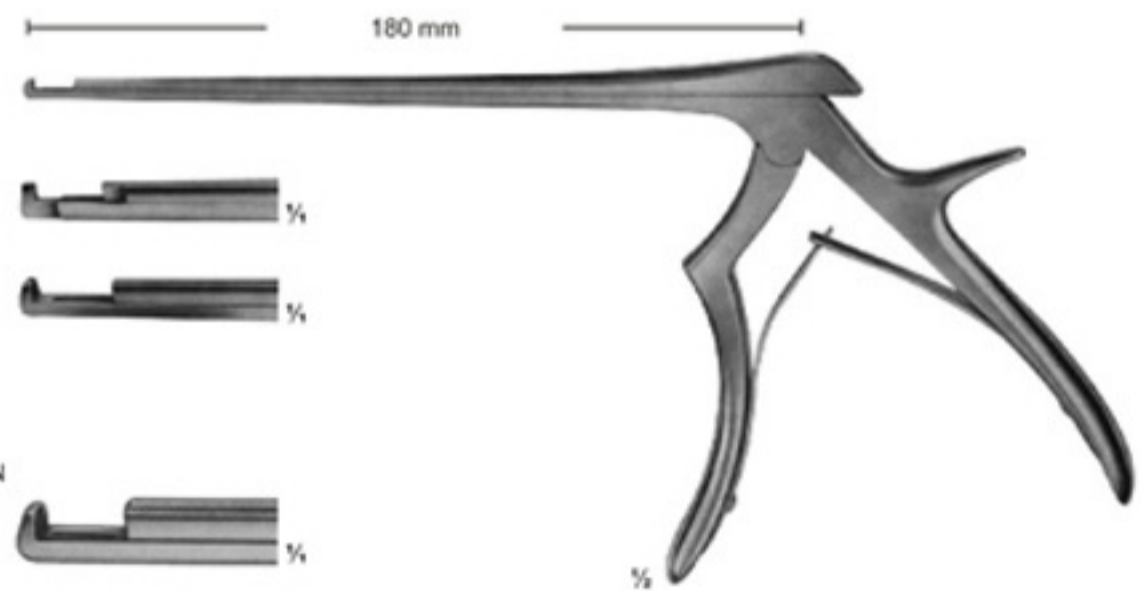

18-113 - 117
KERRISON-JACOBY

Angled positions for rongeurs

- 18-118**
3,0 mm
- 18-119**
3,6 mm
- 18-120**
4,2 mm
- 18-121**
4,8 mm
- 18-122**
5,8 mm

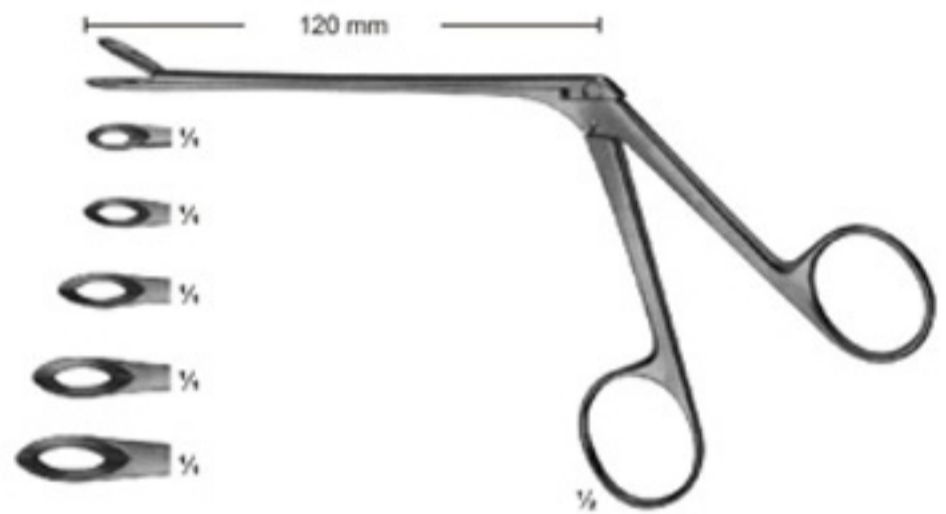

18-118 - 122
WEIL-BLAKESLEY



18-123
TAKAHASHI
3 mm

130°

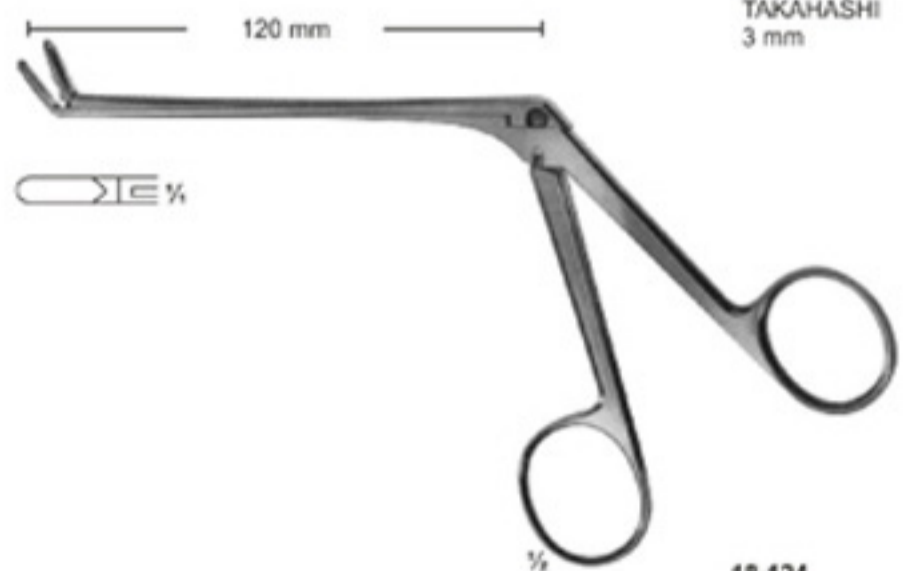

18-124
TAKAHASHI
3 mm

18-125
2 X 10 mm

18-126
3 X 10 mm

18-127
4 X 10 mm

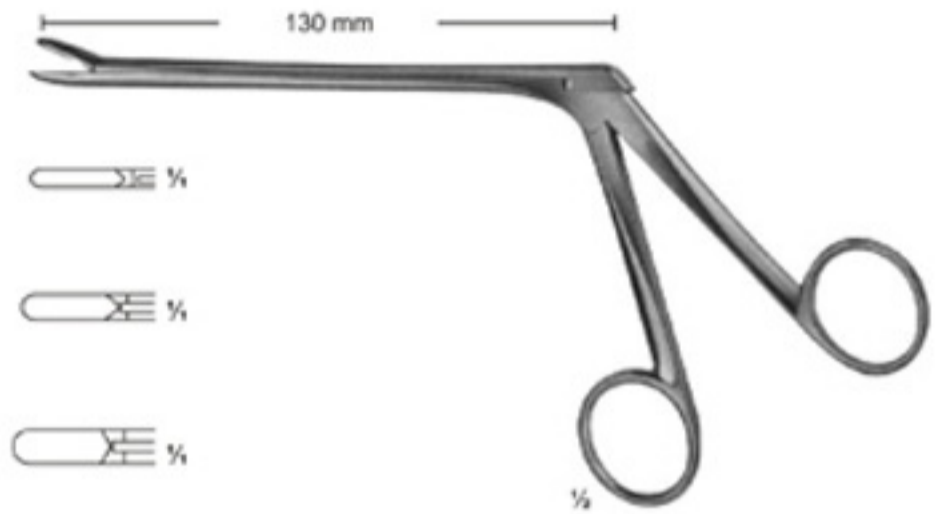

18-125 - 127
LOVE-GRUENWALD

18-128
2 mm

18-129
3 mm

18-130
4 mm

18-131
5 mm

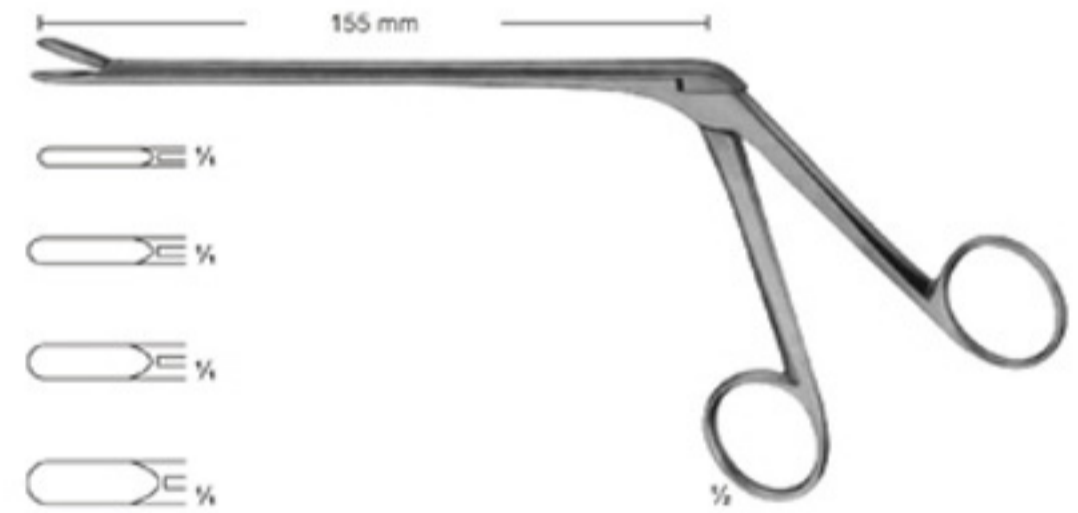

18-128 - 131
CASPAR

18-132
2 mm

18-133
3 mm

18-134
4 mm

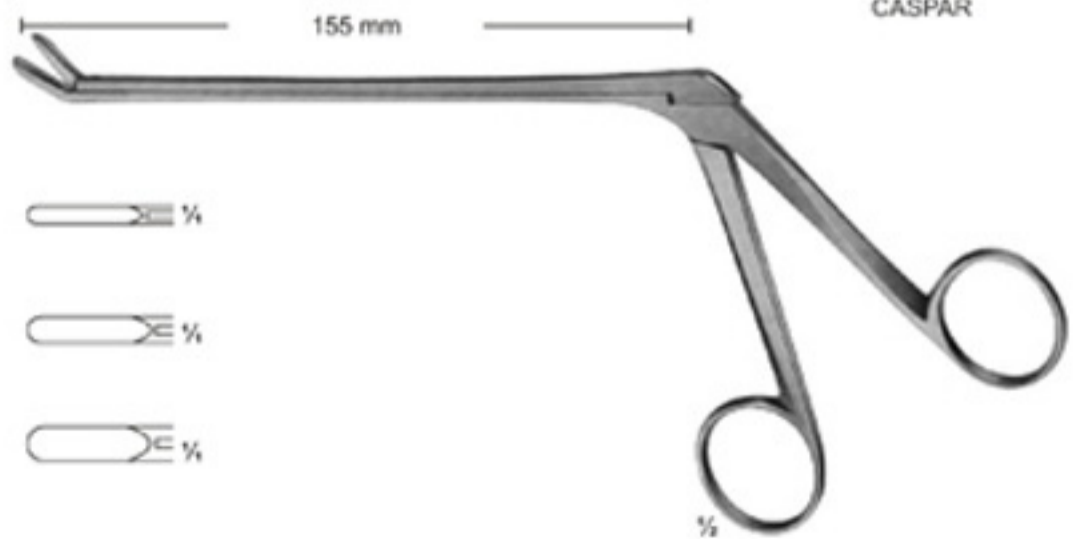

18-132 - 134
CASPAR

18-135
2 mm

18-136
3 mm

18-137
4 mm



18-135 - 137
CASPAR

Length of shaft 140 mm	Length of shaft 160 mm	Length of shaft 185 mm	size of jaws
18-138	18-143	18-148	2 X12 mm
18-139	18-144	18-149	3 X12 mm
18-140	18-145	18-150	4 X14 mm
18-141	18-146	18-151	5 X14 mm
18-142	18-147	18-152	6 X16 mm



18-138 - 152
CASPAR

Length of shaft 140 mm	Length of shaft 160 mm	Length of shaft 185 mm	size of jaws
18-153	18-156	18-159	3 X12 mm
18-154	18-157	18-160	4 X14 mm
18-155	18-158	18-161	5 X14 mm



18-153 - 161
CASPAR

Length of shaft 140 mm	Length of shaft 160 mm	Length of shaft 185 mm	size of jaws
18-162	18-164	185-166	3 X 12 mm
18-163	18-165	18-167	4 X 14 mm

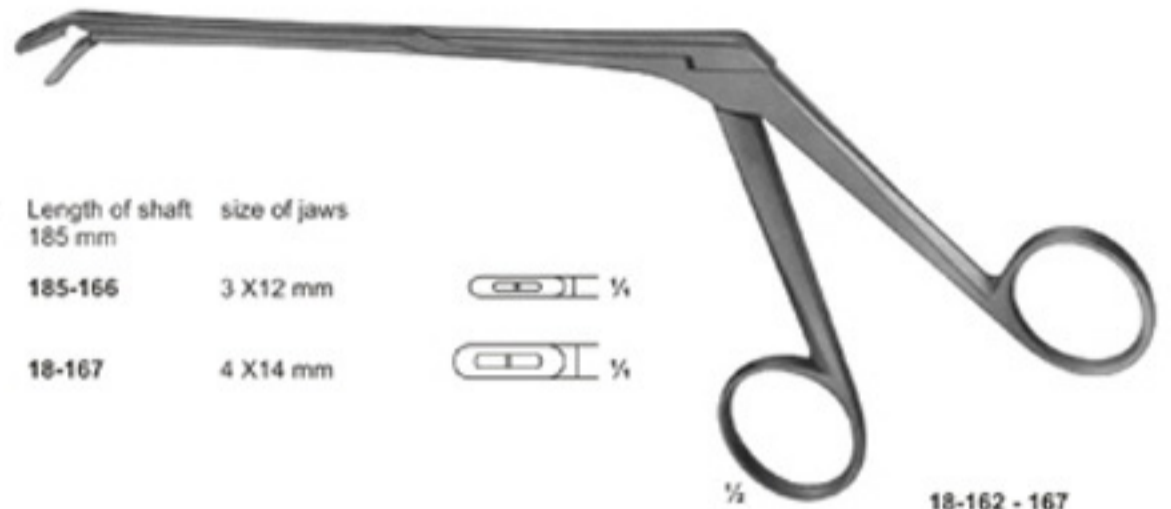

18-162 - 167
GUSHING

18-168
2 X 10 mm
GUSHING



18-169
3 X 10 mm
LOVE-GRUENWALD



18-170
4 X 10 mm
SPURLING

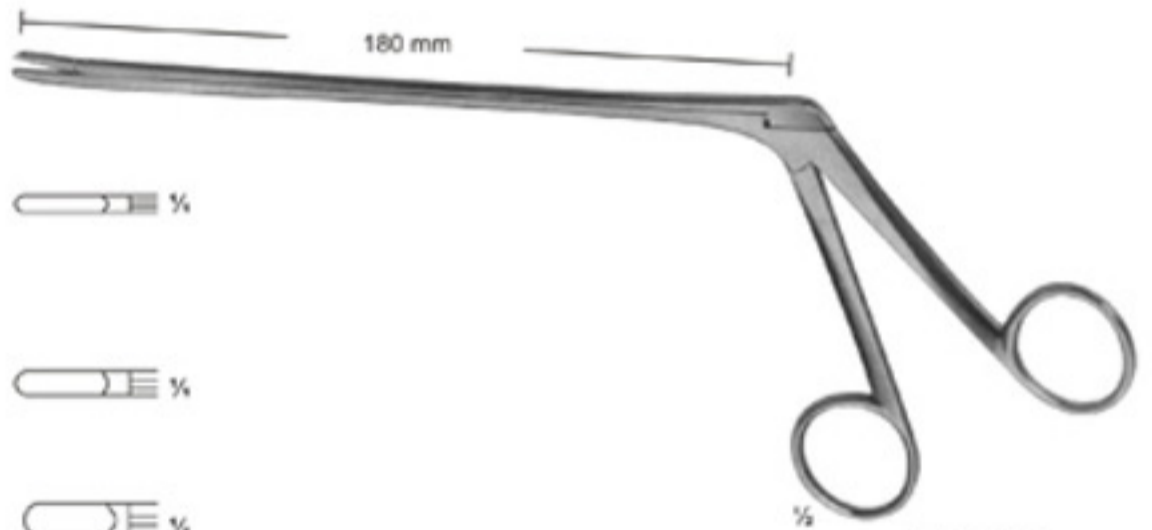

18-168 - 170
LOVE-GRUENWALD

18-171
3 X 10 mm
LOVE-GRUENWALD



18-172
4 X 10 mm
SPURLING



18-171 - 172
LOVE-GRUENWALD

18-173
3 X 10 mm
LOVE-GRUENWALD

18-174
4 X 10 mm
SPURLING

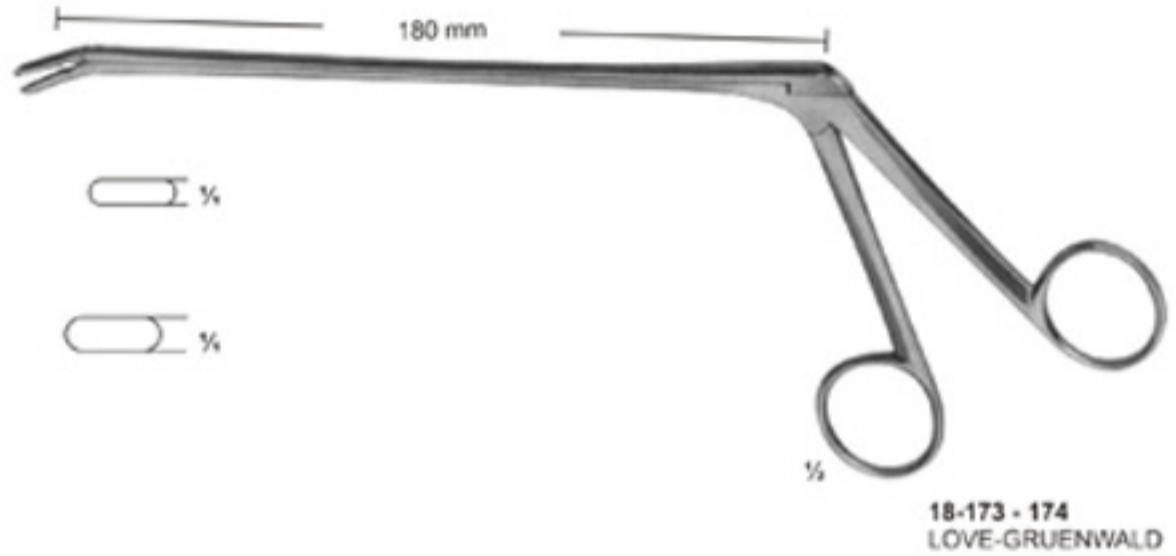

18-175
7 mm

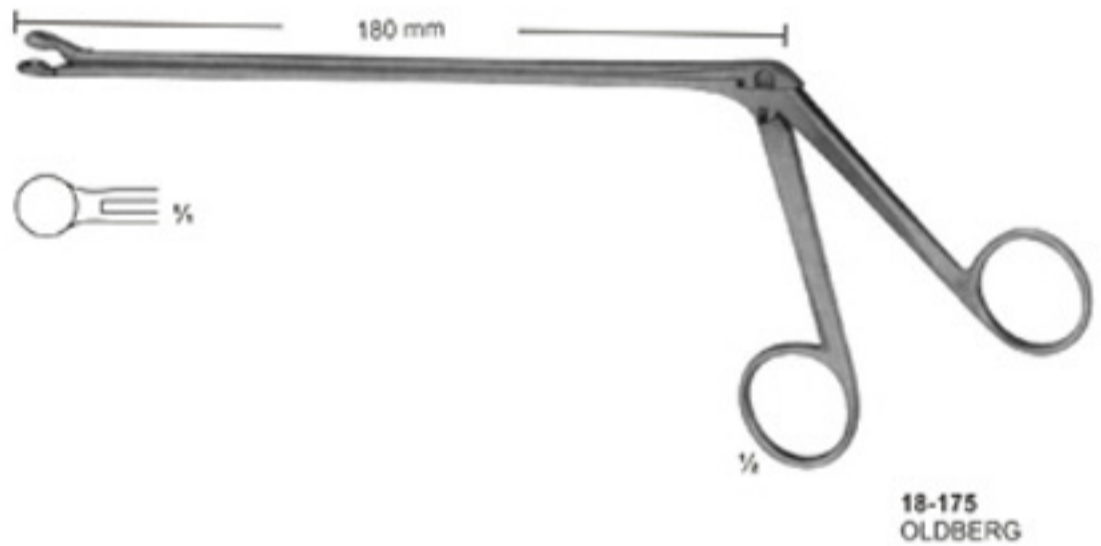

18-176
YASARGIL
2,2 mm

18-177
YASARGIL
3,5 mm

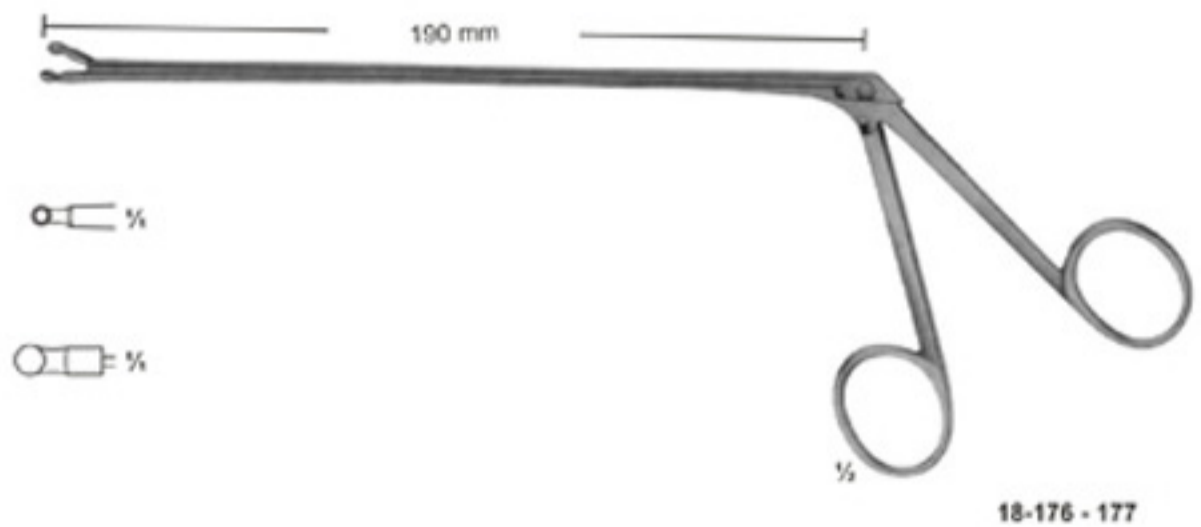

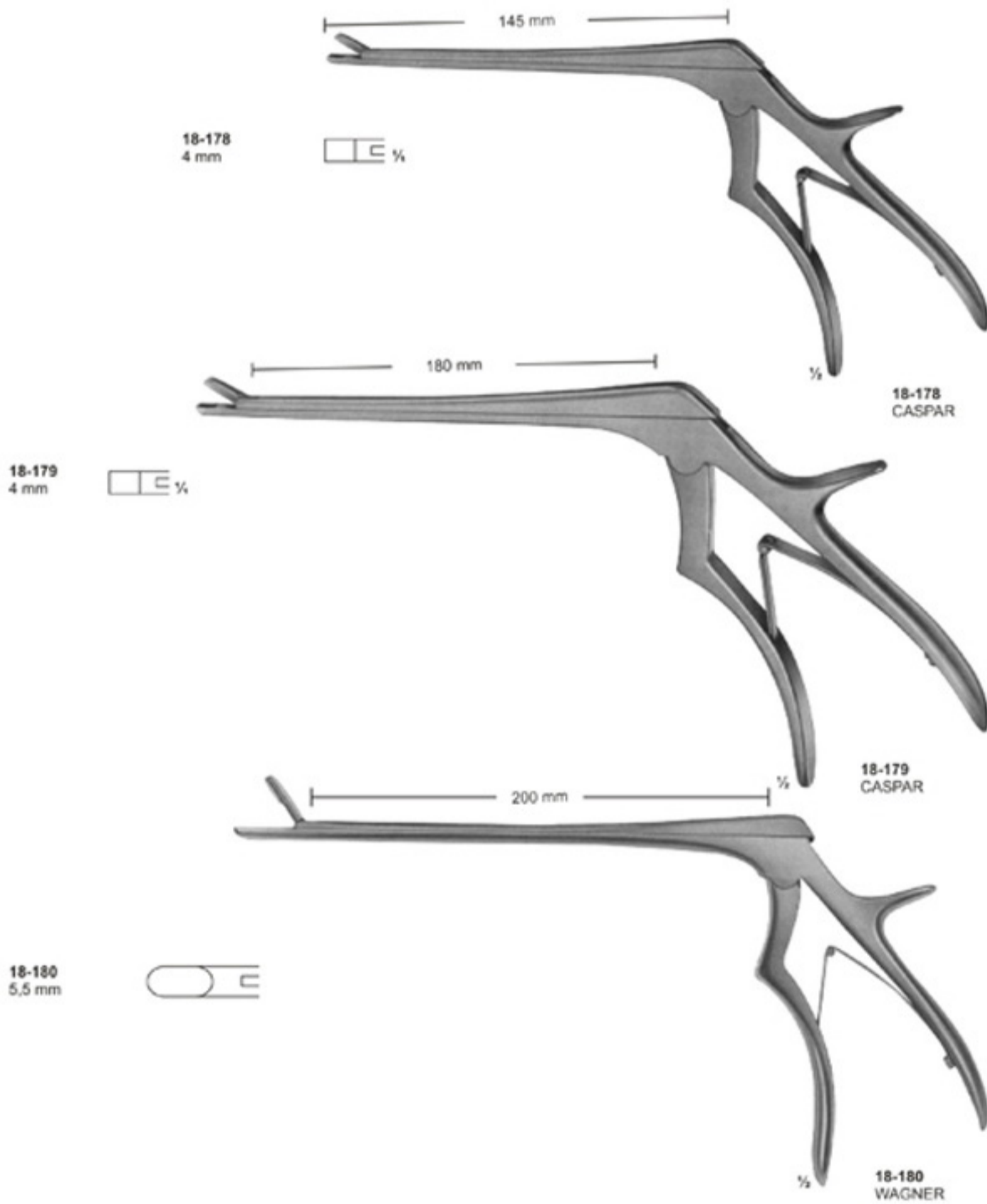

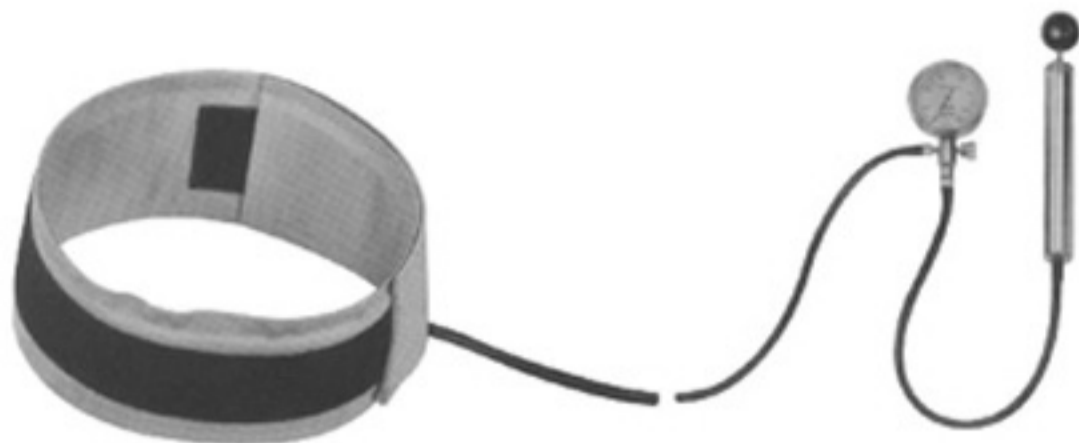

19-101
Comprimeter. Compression apparatus for producing exsanguination in the extremities. Manometer registers up to 600 mm Hg. Complete, consisting of :
19-101 2 Pump with manometer
19-102 3 Cuff for the leg
19-103 14 Cuff for the upper arm



19-104 3 Cuff for the leg
19-105 4 Cuff for the lower arm
19-106 5 Cuff for children
19-107 14 Cuff for the upper arm



19-108
ESMARCH
Staubinde
Compression bandage
5 m lang/long
6 cm breit/wide



19-109
ESMARCH
Stauschlauch
Compression tube
1 m lang/long



19-110
Length of blades
Phalangeal knife
105 mm



19-111
Length of blades
Interosseous knife
110 mm



19-112
Length of blades
Periosteum knife
with raspatory
65 mm



19-113 - 114
LANGENBECK
Length of blades
Resection knives
55 mm



19-113



19-114

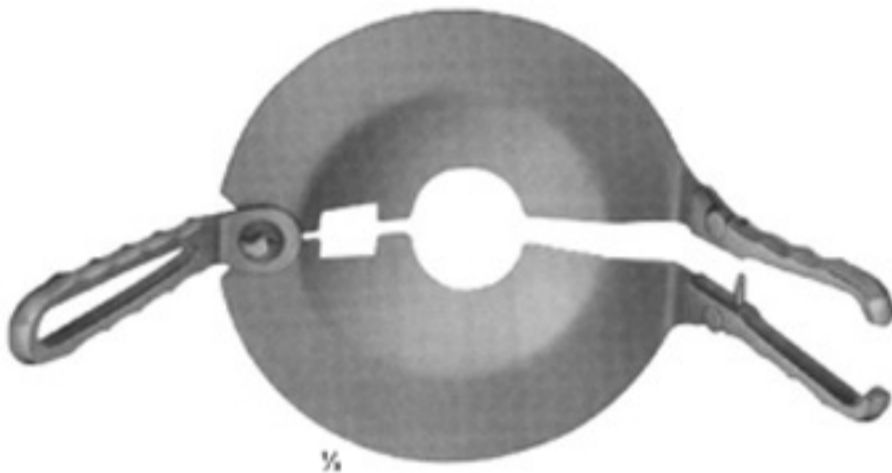

1/4

19-115
PERCY
removeable handles

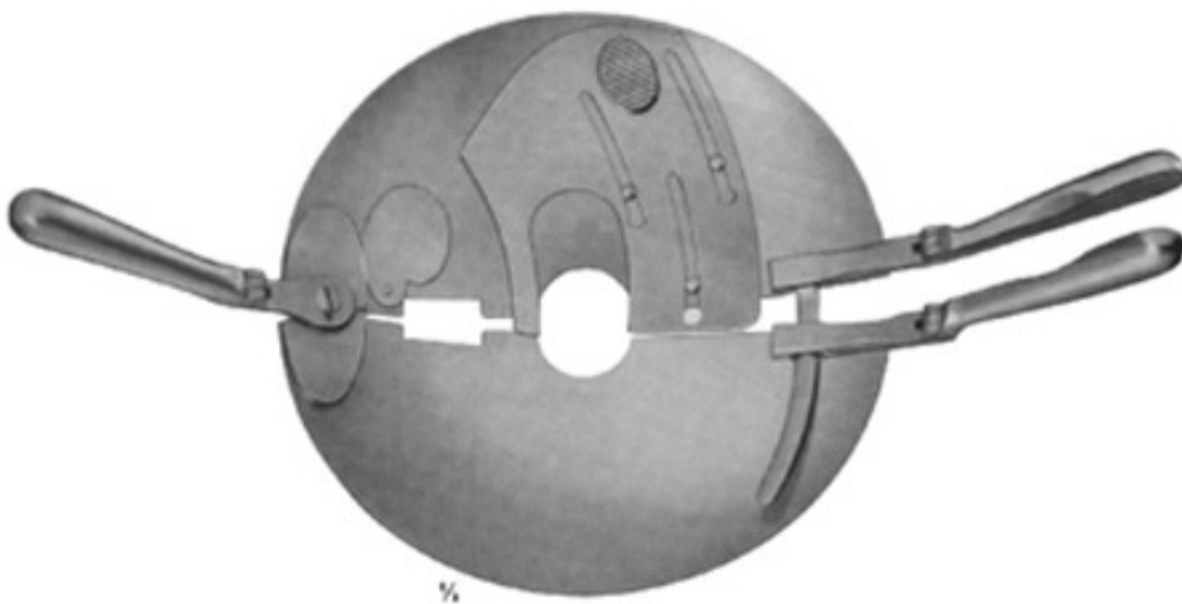

1/4

19-116
PERCY
reversible handles



19-117 $\frac{1}{4}$
 CHARRIER
 Length of blade
 215 mm
 complete with one saw
 blade each
 350 mm
 Spare saw blades, carbon steel
19-118 12 mm
19-119 20 mm



19-120 $\frac{1}{4}$
 RUST
 Length of blade
 235 mm
 complete with one saw
 blade each
 390 mm
19-121 Bow only
 Spare saw blades, carbon steel
19-122 6 mm
19-123 8 mm
19-124 12 mm
19-125 20 mm

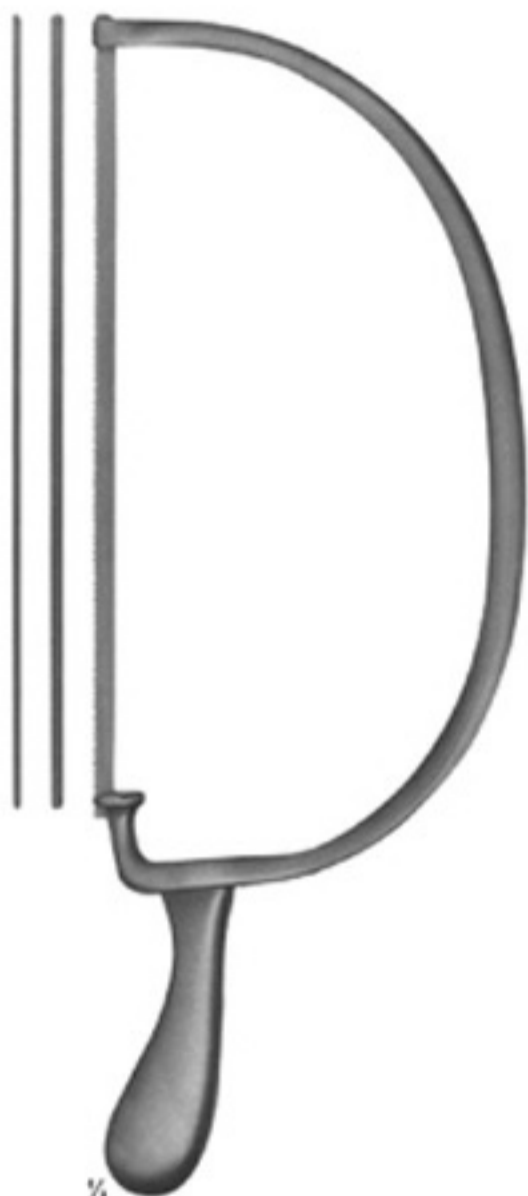

1/2
19-126
BIER
 Length of blade
 270 mm
 complete with one saw
 blade each
 420 mm
 Spare saw blades, carbon steel
19-127 4 mm
19-128 6 mm
19-129 8 mm



1/2
19-130
CHARRIERE
 Length of blade
 180 mm
 Spare saw blades,
 carbon steel
 270 mm

19-131
CHARRIERE
 Length of blade
 240 mm
 Spare saw blades,
 carbon steel
 340 mm



1/2
19-132
SATTERLEE
 Length of blade
 200 mm
 Spare saw blades,
 carbon steel
 290 mm



1/2
19-133
LANGENBACK
 Length of blade
 115 mm
 Metacarpal saw
 235 mm



OLIVECRONA
19-134 300 mm
19-135 400 mm
19-136 500 mm
19-137 700 mm



GIGLI
19-138 300 mm
19-139 400 mm
19-140 500 mm
 fine, 6 wires twisted
19-141
 coarses, 4 wires twisted



19-142
GIGLI
 Handle



19-143
LEBSCHKE
 Conductor for
 wire saws, malleable
 250 mm

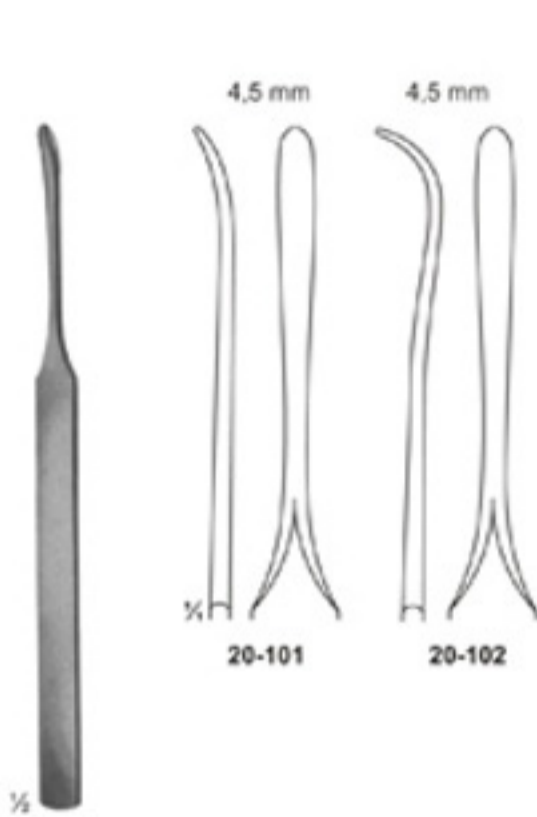

20-101 - 102
KONIG
155 mm



20-103
WILLIGER
165 mm

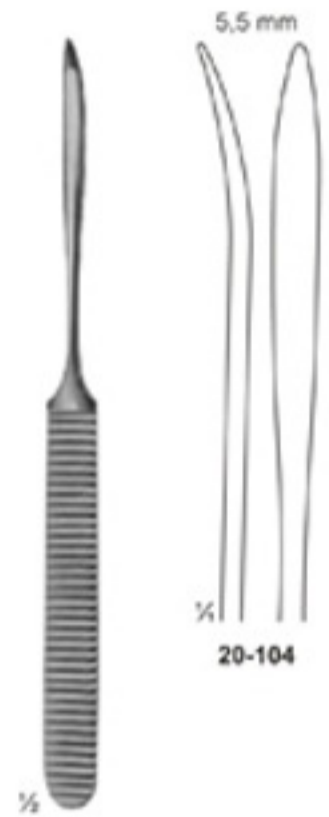

20-104
WILLIGER
170 mm

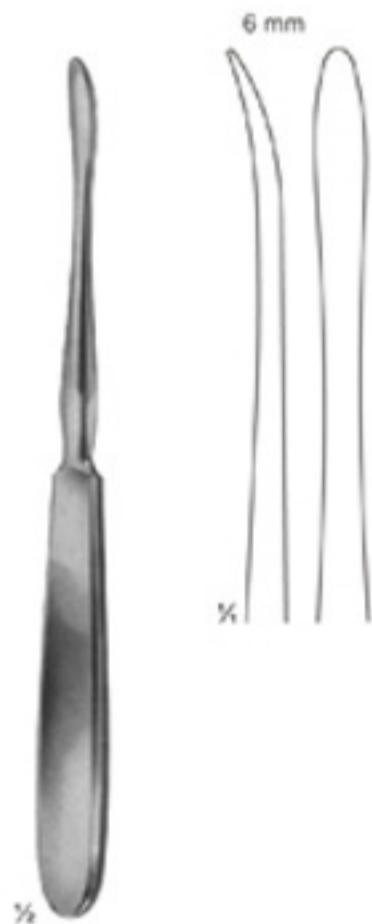

20-105
QUERVAIN
195 mm

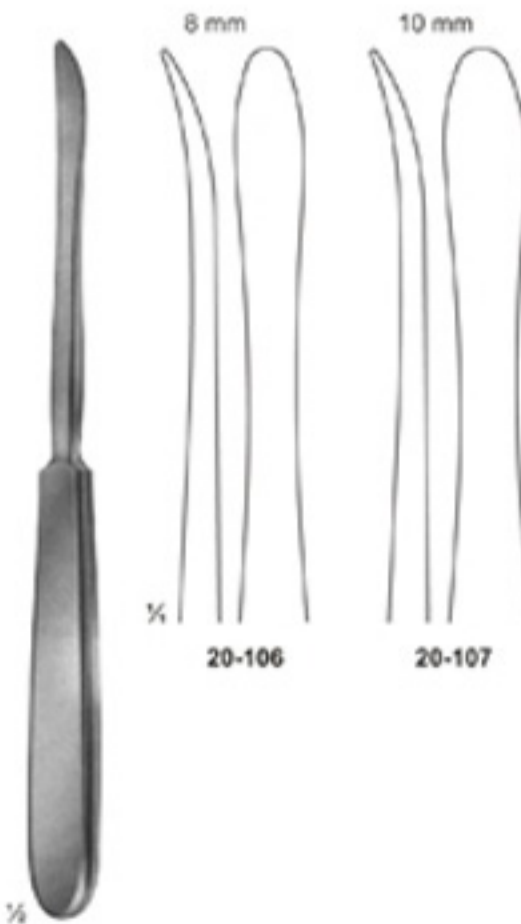

120-106 - 107
LANGENBACK
195 mm

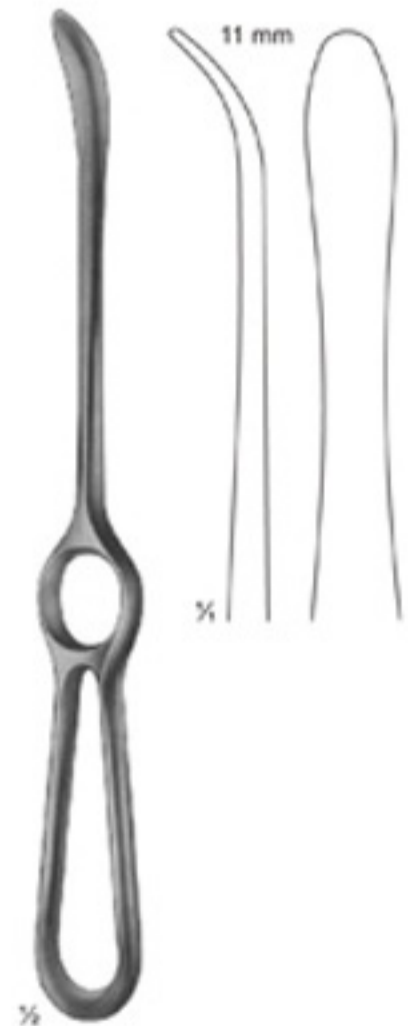

20-108
LANGENBACK
230mm

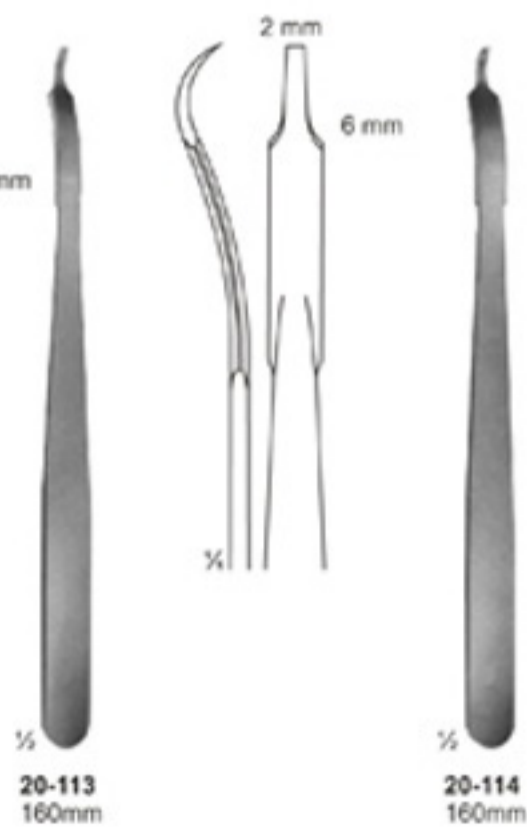
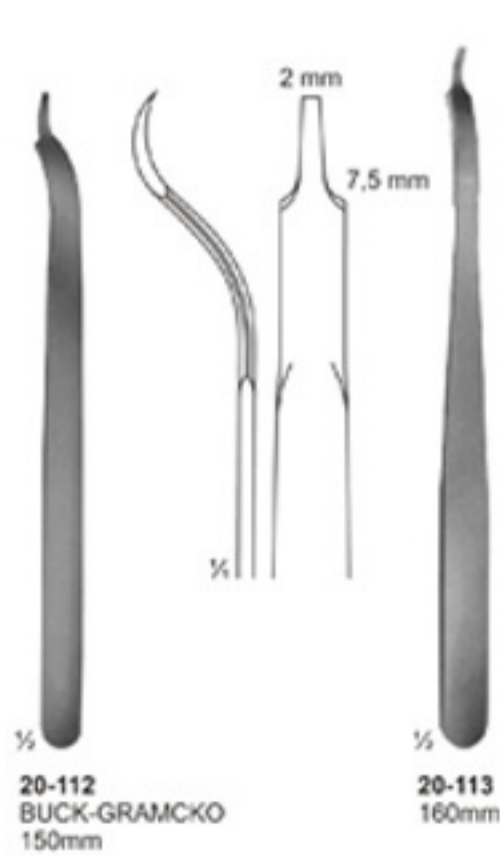
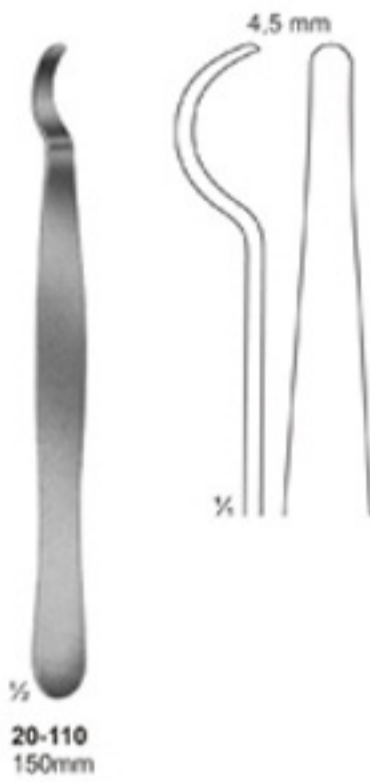
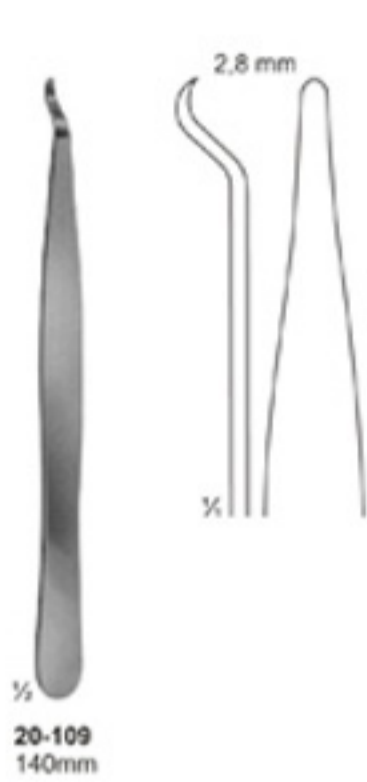



20-116
LANE TRETOWAN
215mm

20-117
LANE
255mm

20-118
LANGE-HOHMANN
250mm

20-119 - 120
LANGE-HOHMANN
20-119 265mm
20-120 280mm

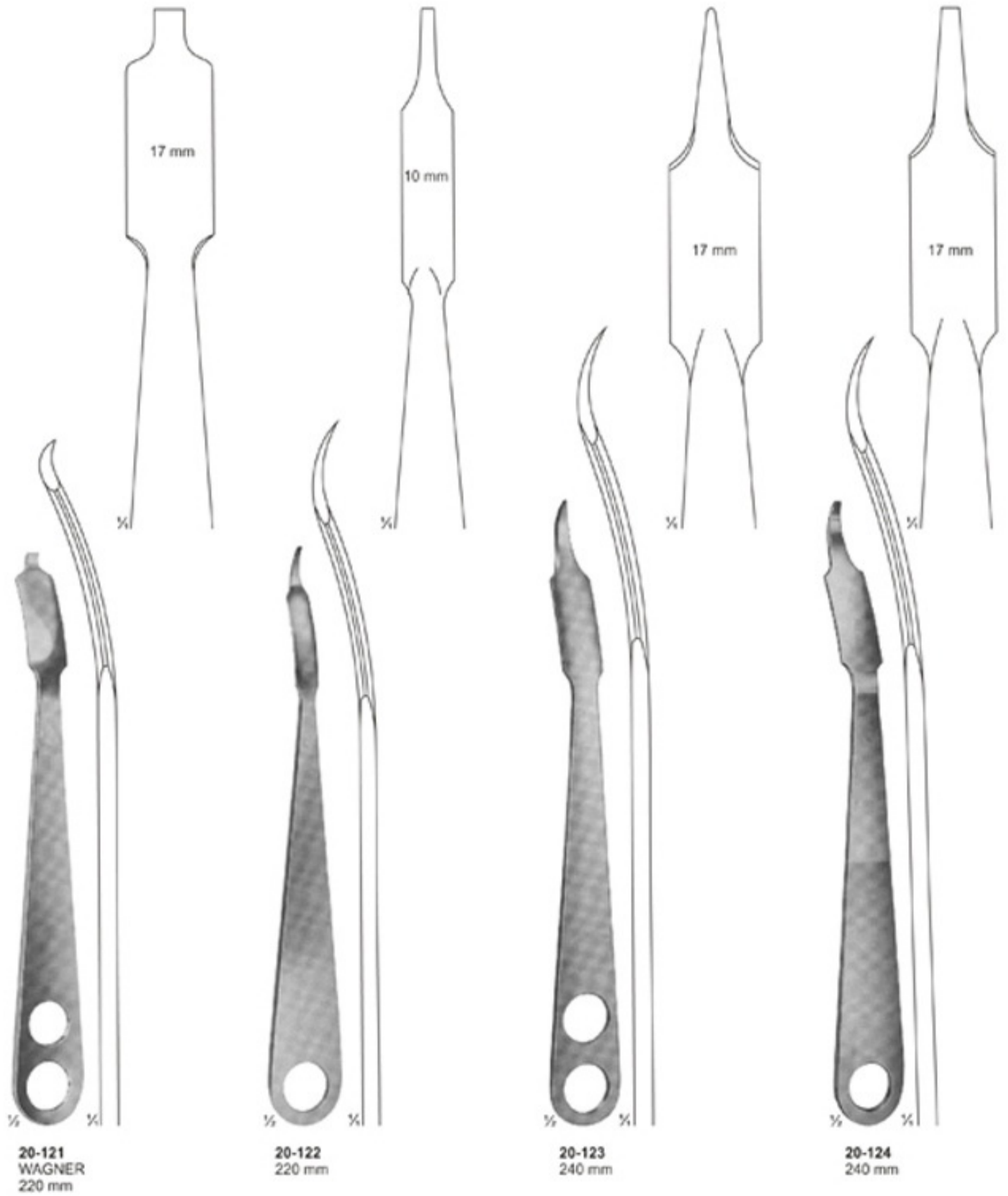

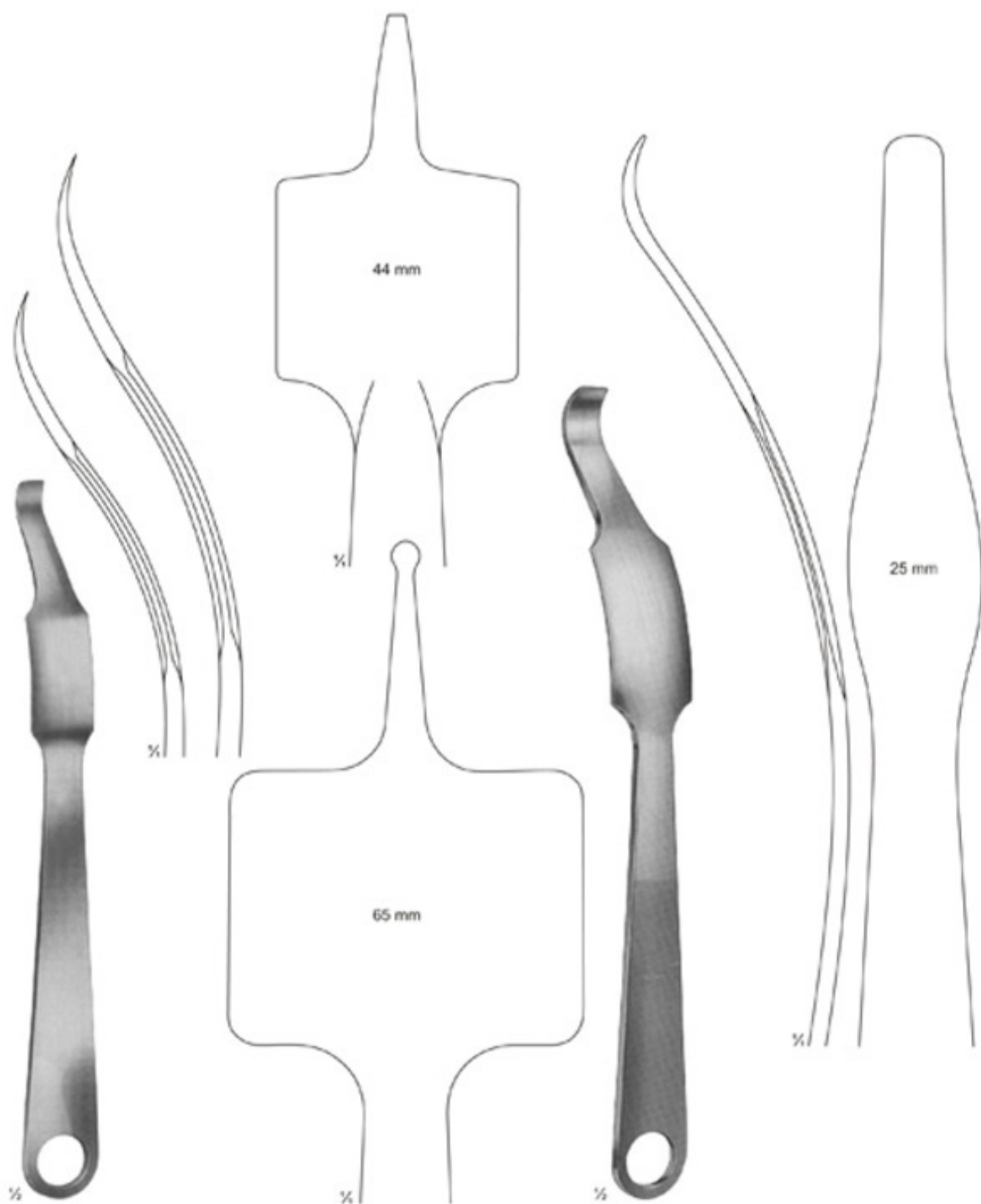

20-125 - 126
VERBRUGGE-MULLER
 20-125 240 mm
 20-126 255 mm

20-127
 260 mm

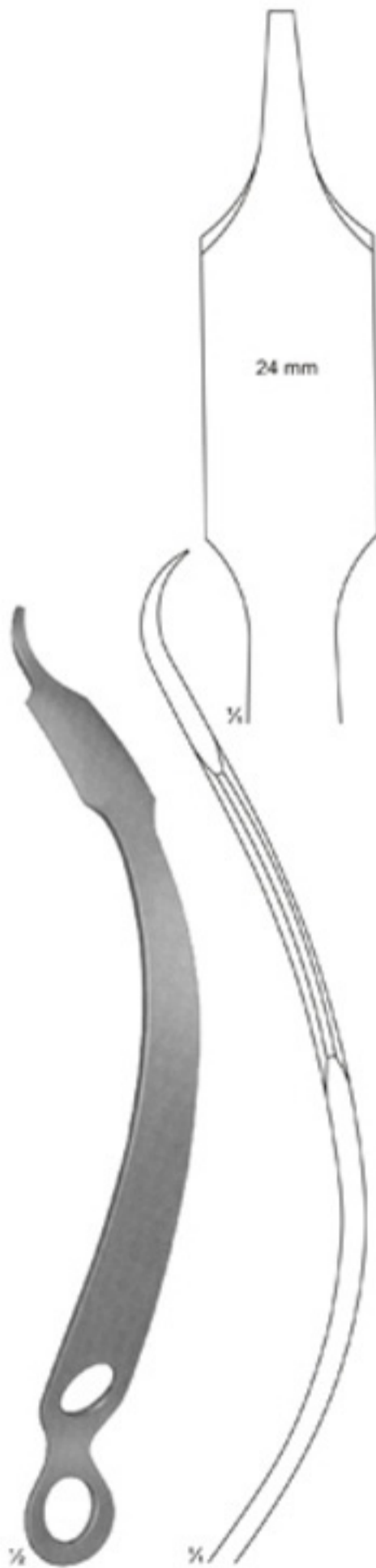

20-128
HOHMANN-ALDINGER
270 mm

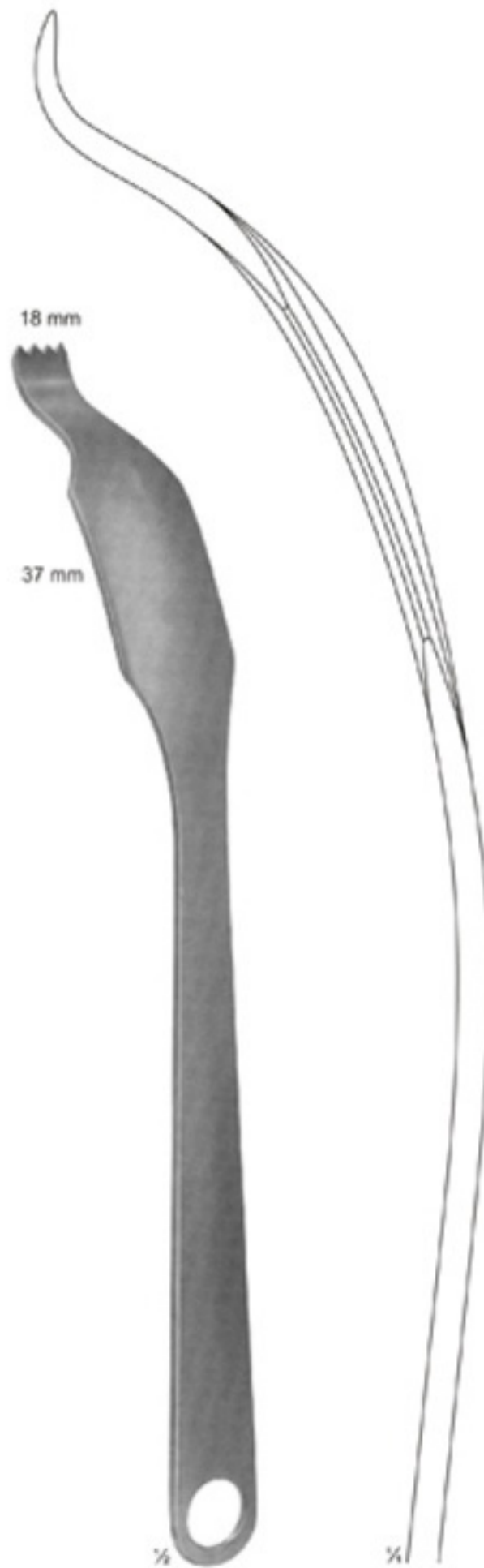

20-129
SCHUMACHER mod. WAGNER
345 mm

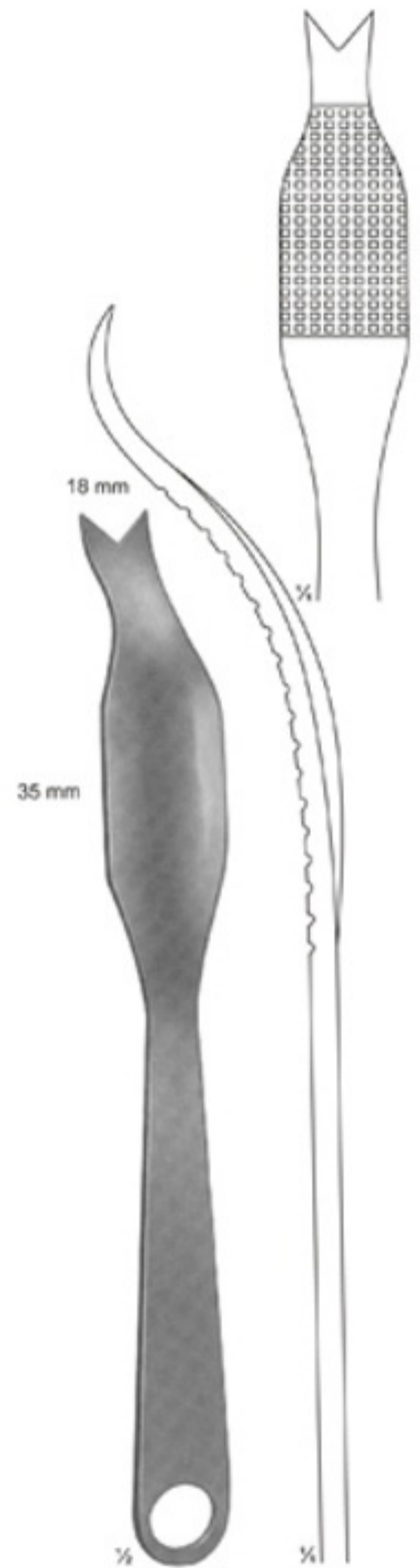

20-130
SCHUMACHER
290 mm

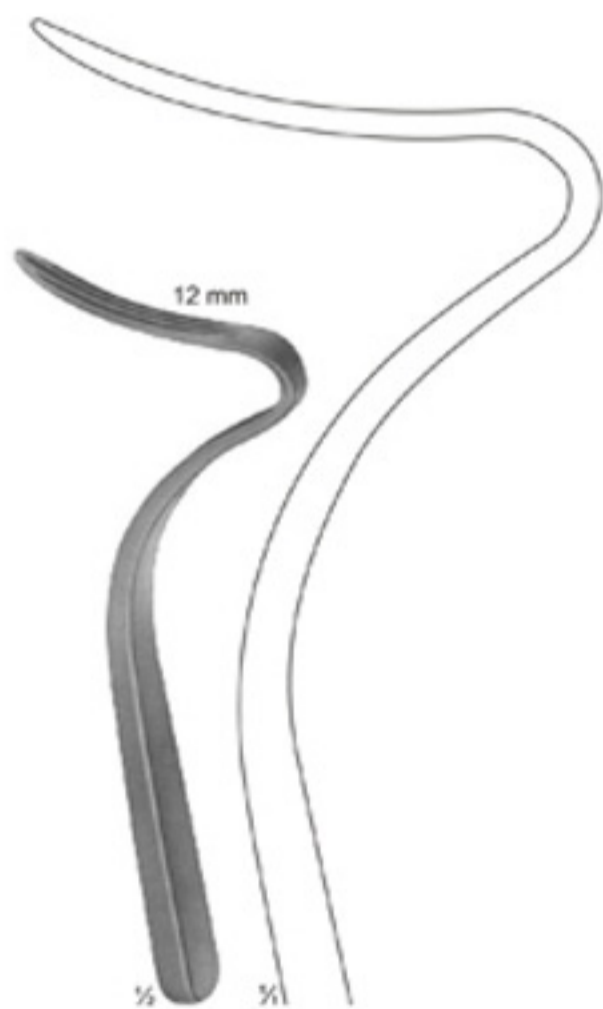

20-131
TAGER
 Bone lever for
 angle joint operations
 175 mm



20-132
BENNETT
 235 mm

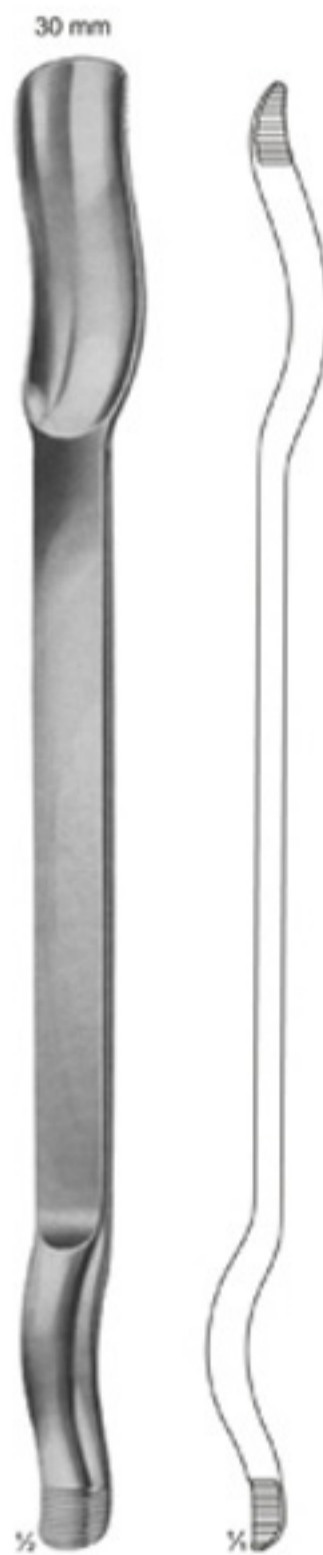

20-133
MURPHY-LANE
 Luxation lever
 340 mm



20-134 - 135
PARTSCH
150 mm

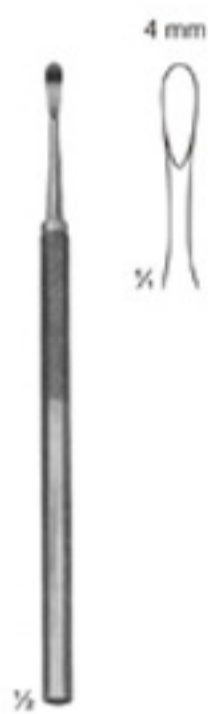

20-136
PARTSCH mod. LANGE
145 mm

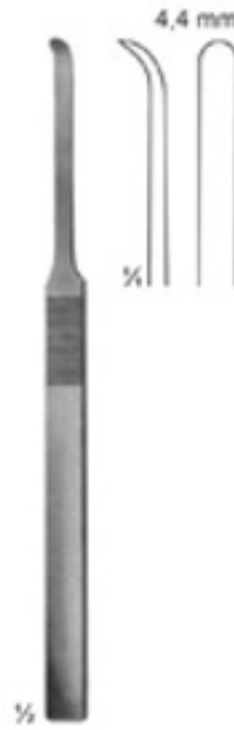

20-137
MC KENTY
155 mm

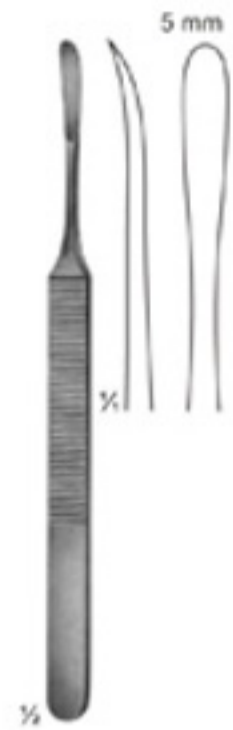

20-138
KONIG
155 mm

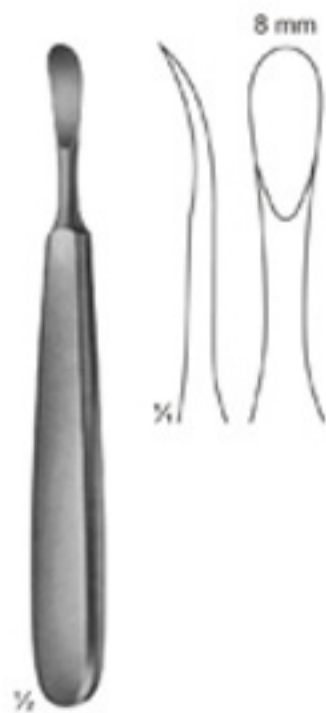

20-139
TRELAT
150 mm

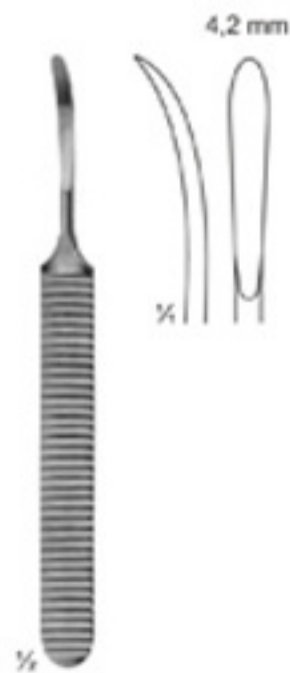

20-140
WILLIGER
140 mm



20-141
WILLIGER
160 mm



20-142
JOSEPH
170 mm

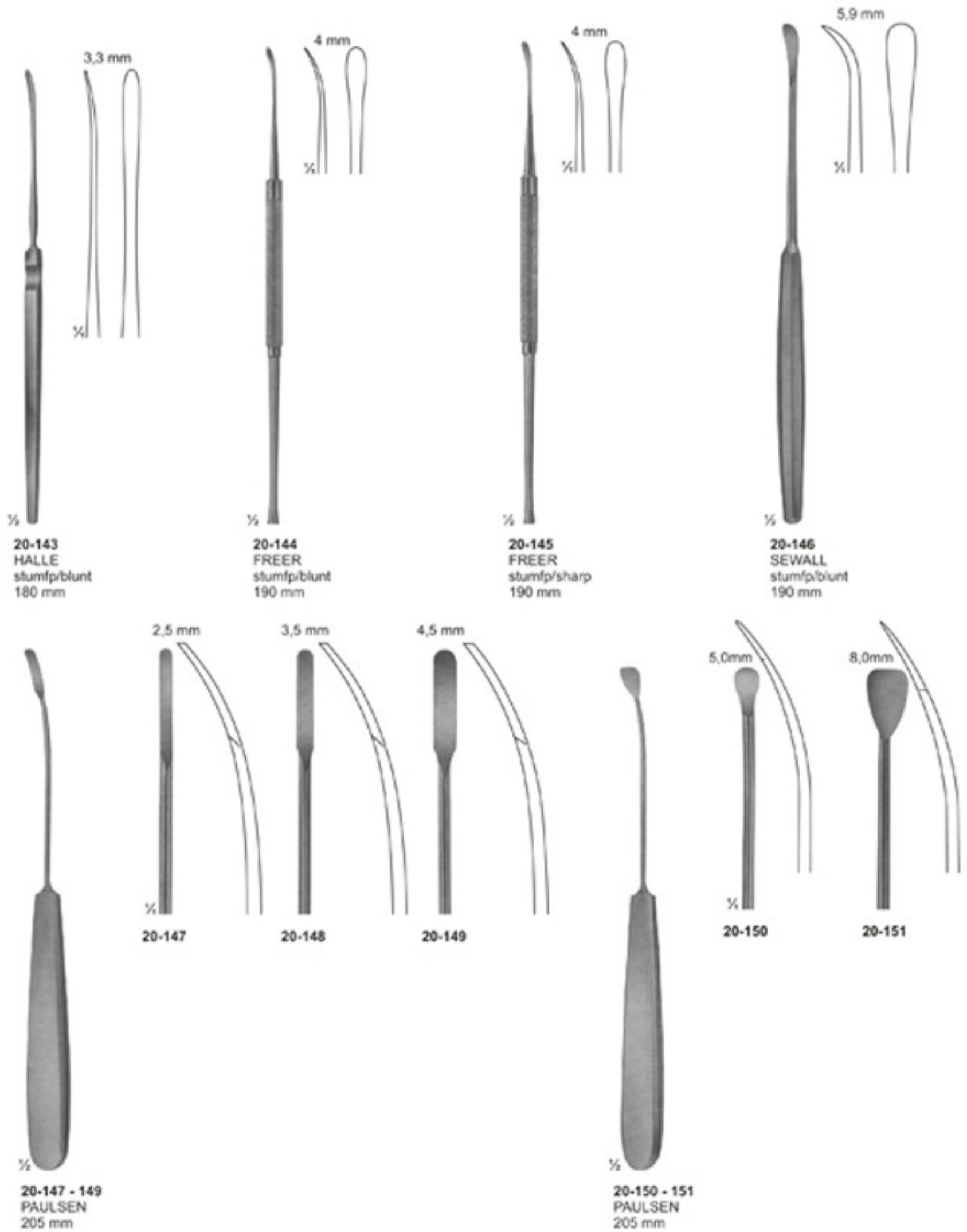

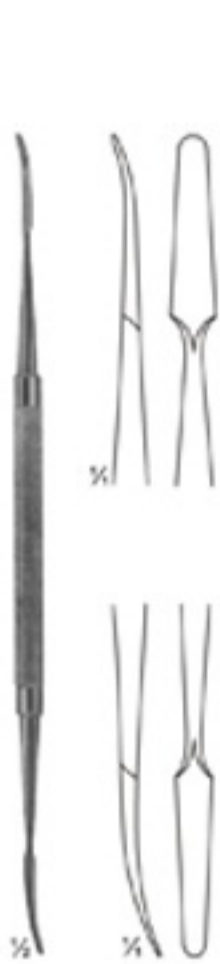

20-152
KILLIAN
sharp/blunt
185 mm

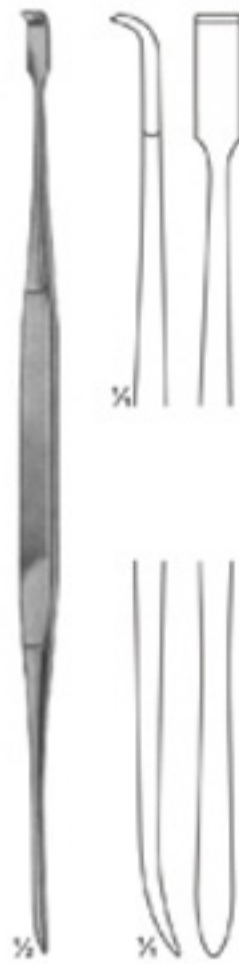

20-153
HOWARTH
sharp/blunt
215 mm



20-154
KILLIAN
sharp/blunt
185 mm

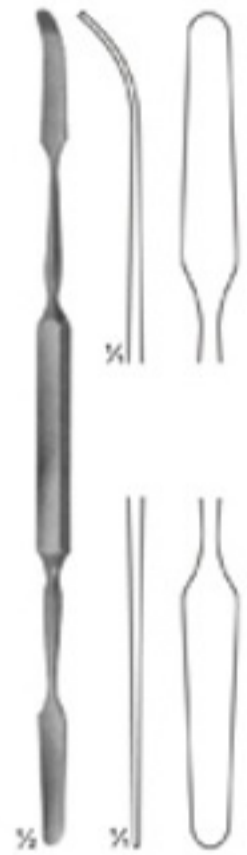

20-155
MAC DONALD
blunt/blunt
185 mm

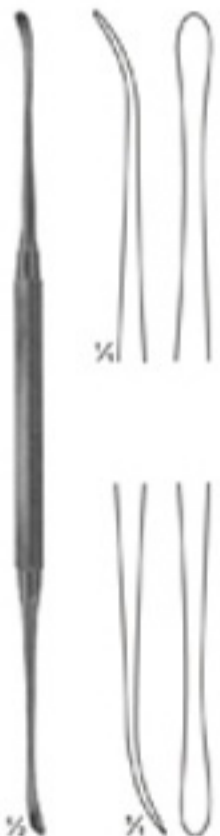

20-156
FREER
sharp/blunt
185 mm



20-157
FREER-YASARGIL
sharp/sharp
185 mm

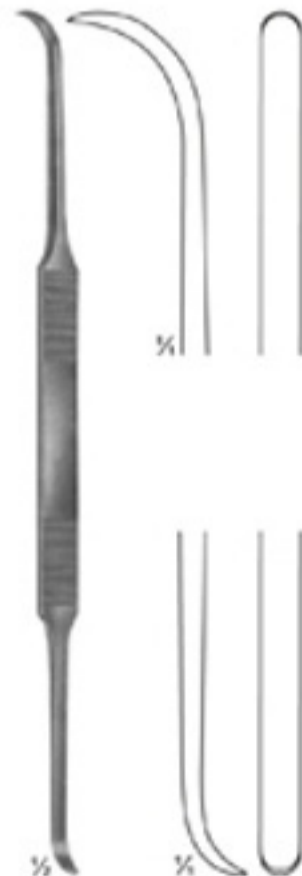

20-158
COTTLE
sharp/sharp
200 mm



20-159
MEAD
sharp/sharp
165 mm

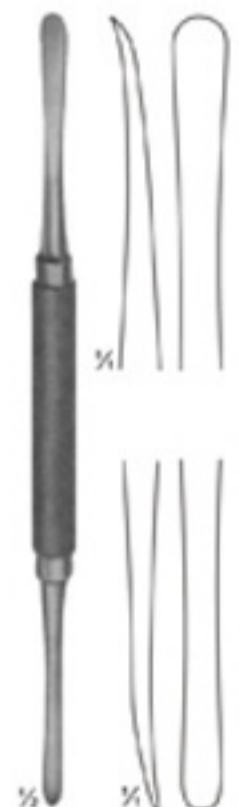

20-160
MOLT
sharp/sharp
180 mm

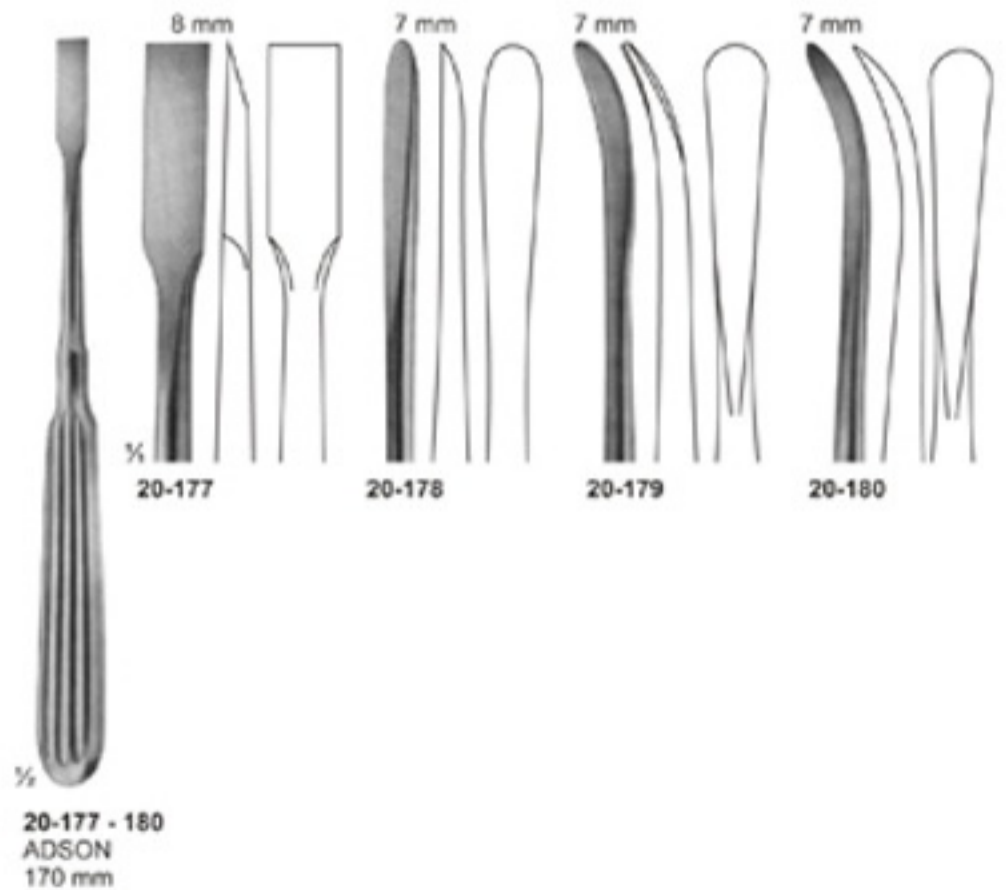
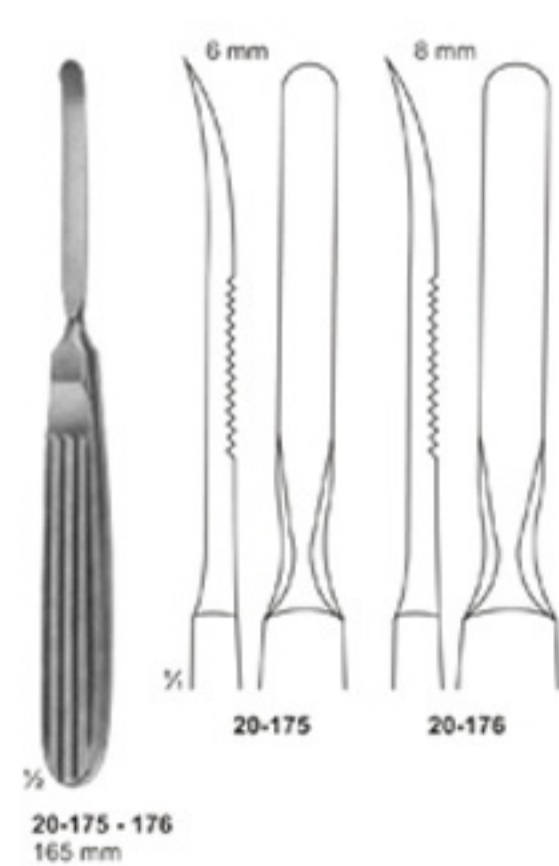
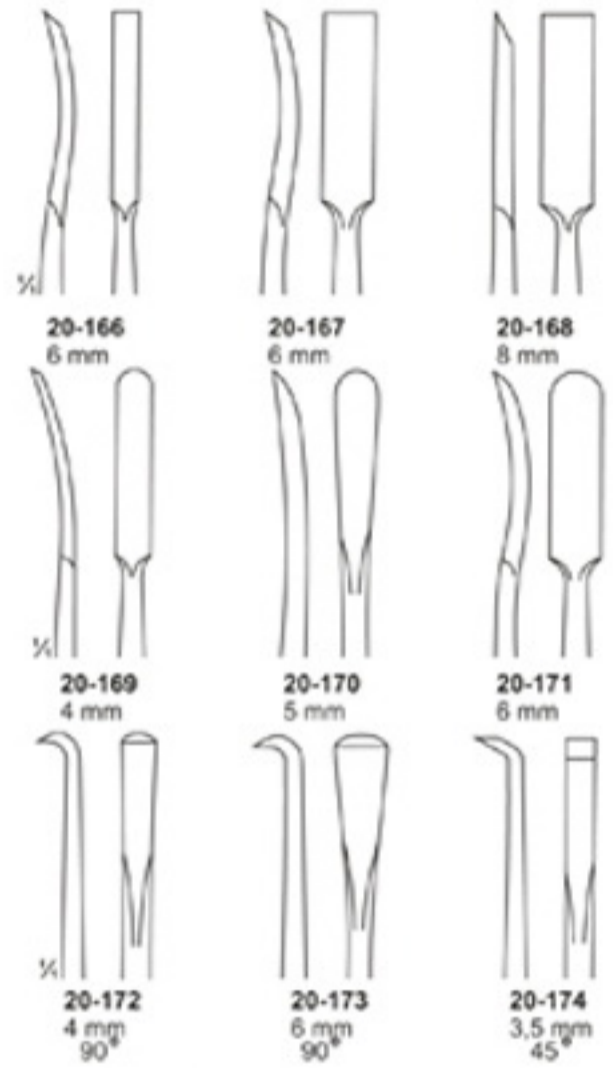
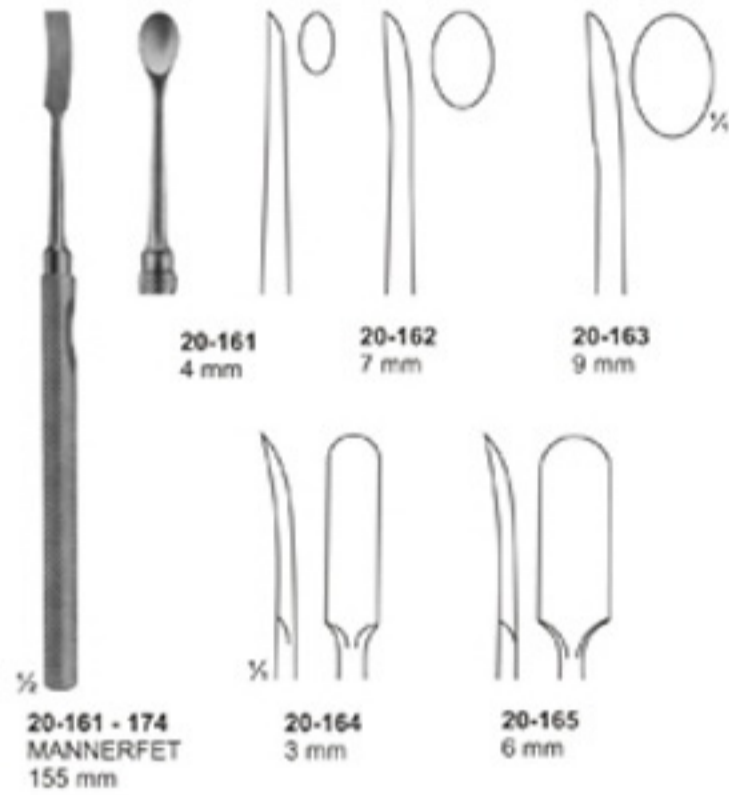

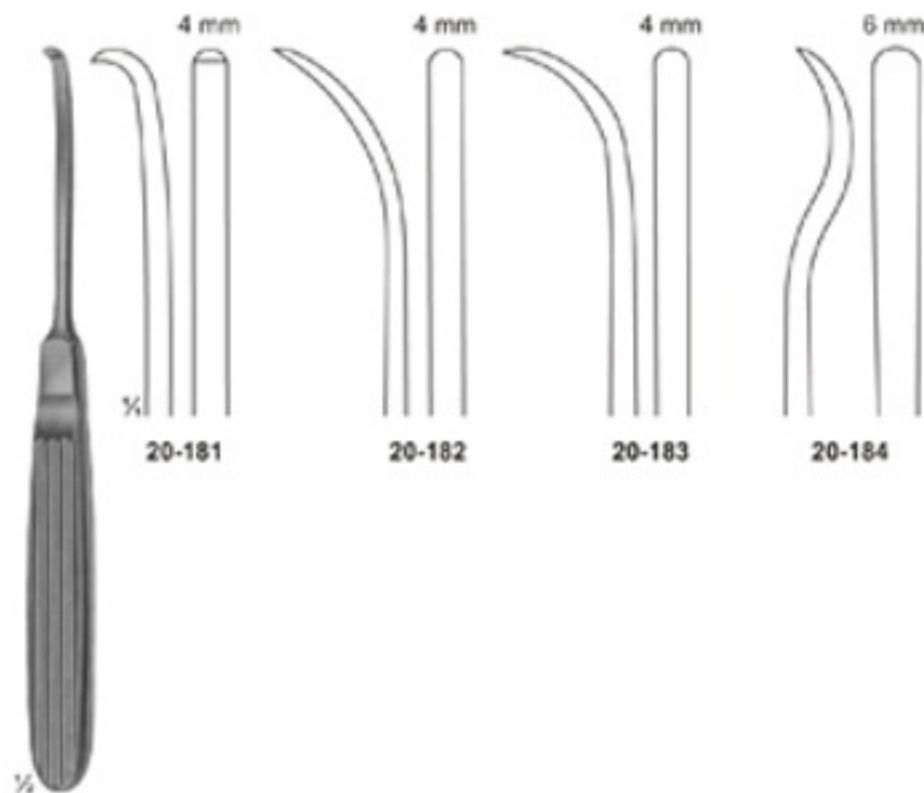

20-181 - 184
MUHLING
170 mm

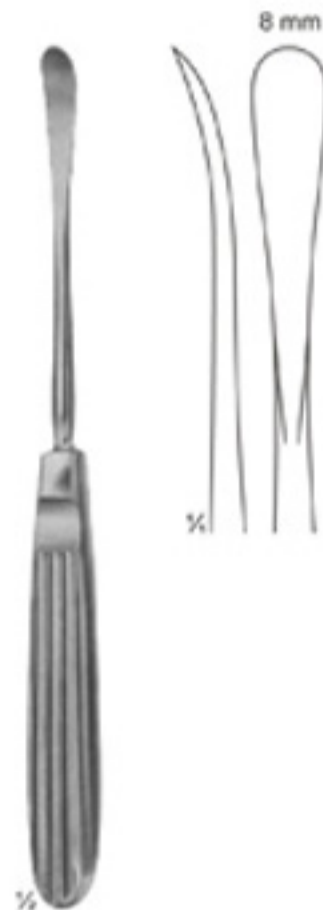

20-185
COTTLE
175 mm

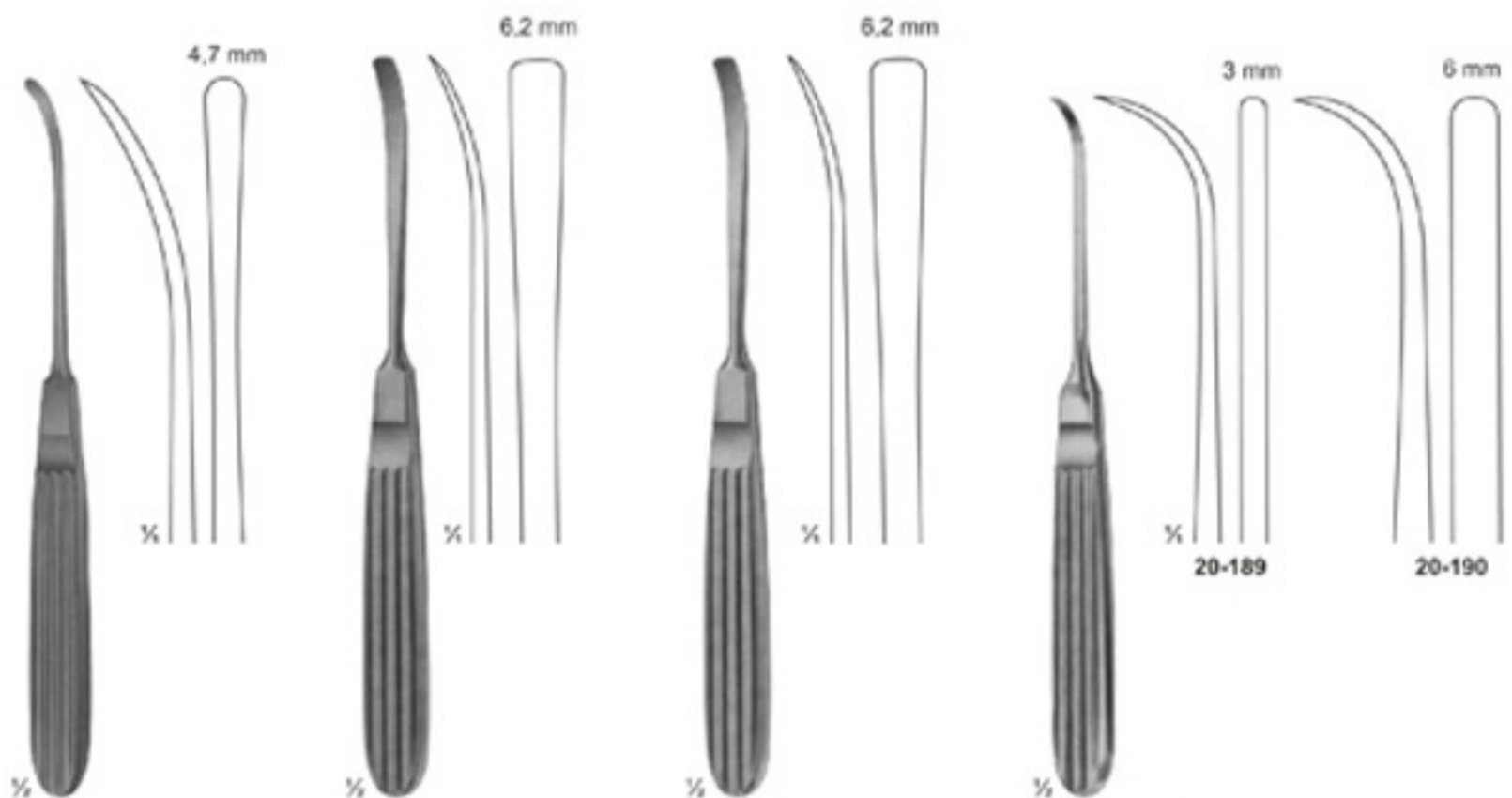

20-186
LANDOT
175 mm

20-187
CASPER
180 mm

20-188
CASPER
180 mm

20-189 - 190
170 mm

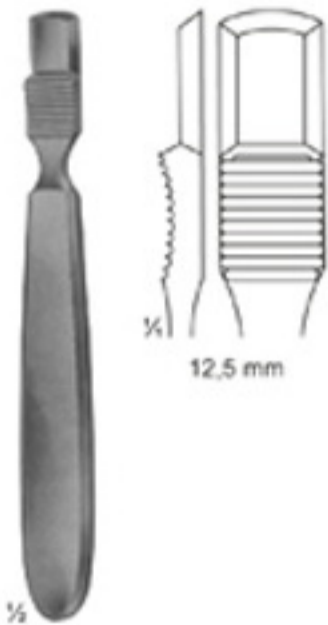

20-191
FARABEUF
140 mm



20-192
FARABEUF
140 mm

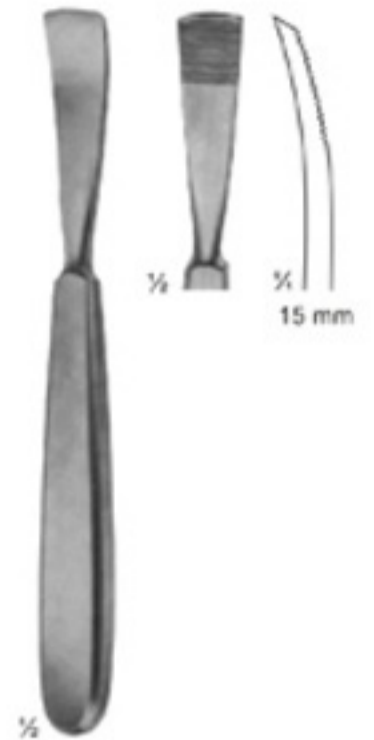

20-193
JANSEN
165 mm

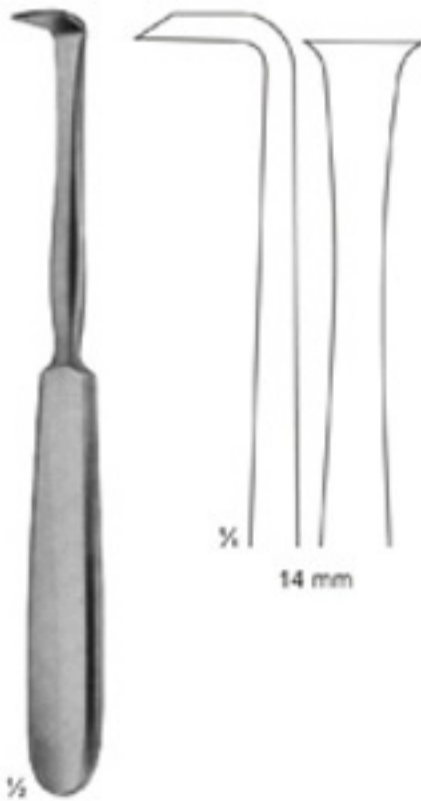

20-194
LANGENBACK
180 mm

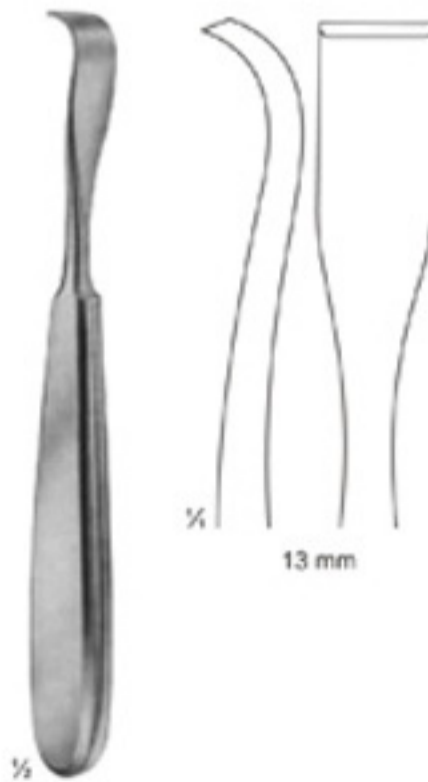

20-195
SCHNEIDER
175 mm

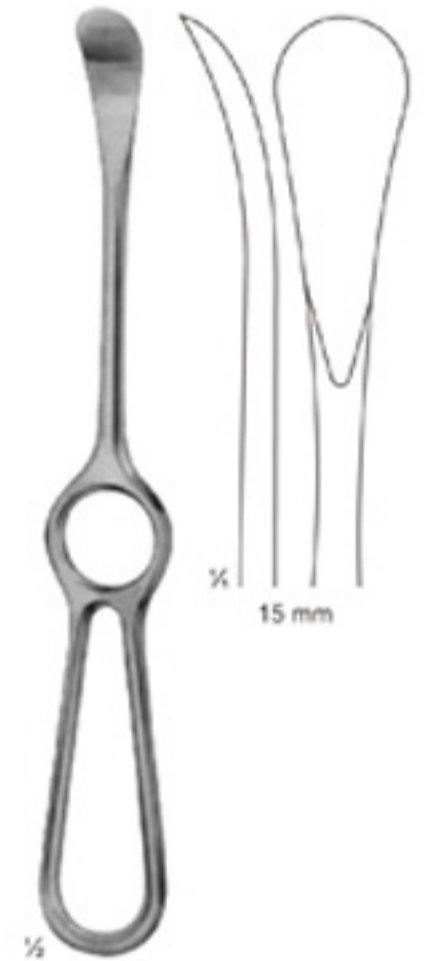

20-196
SEDILLOT
215 mm

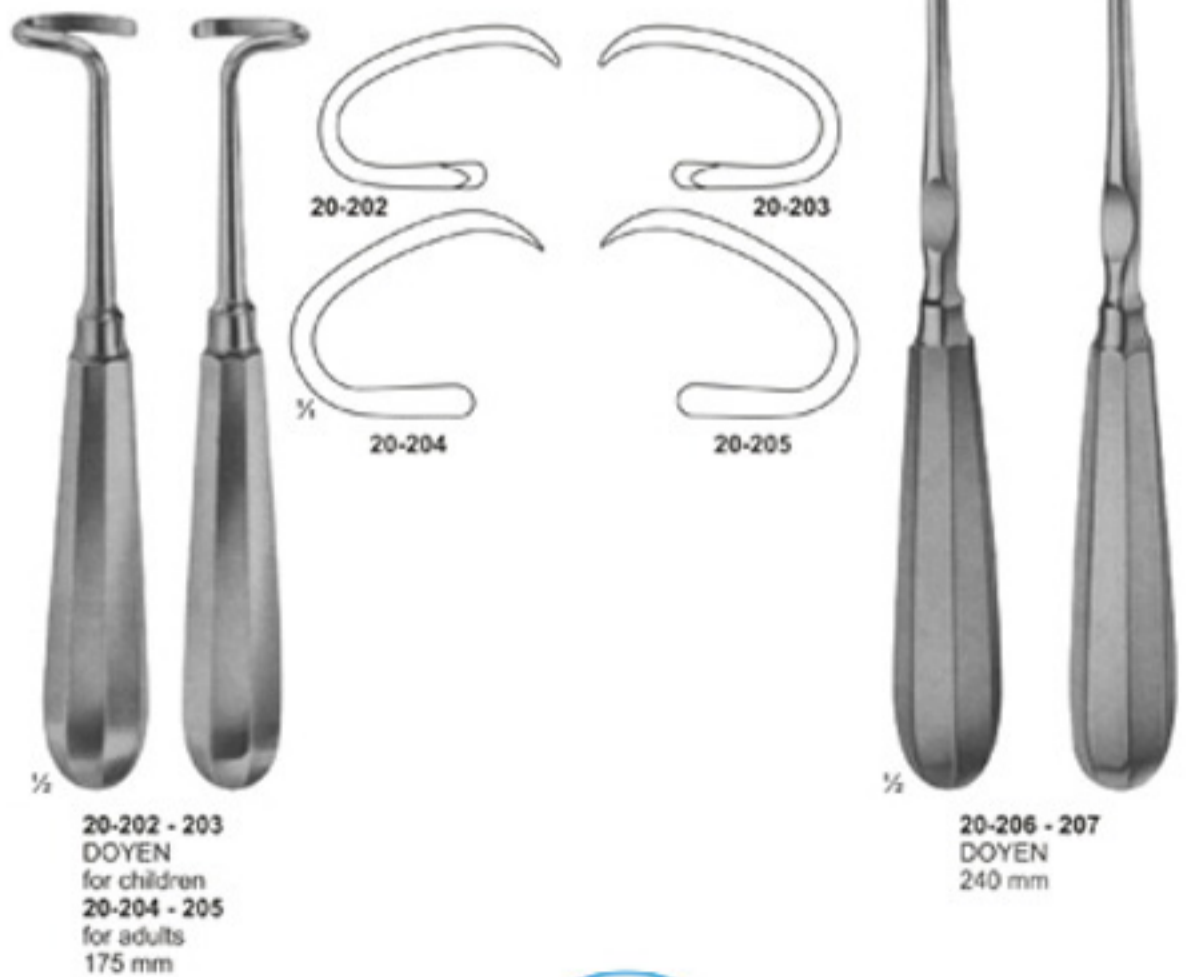
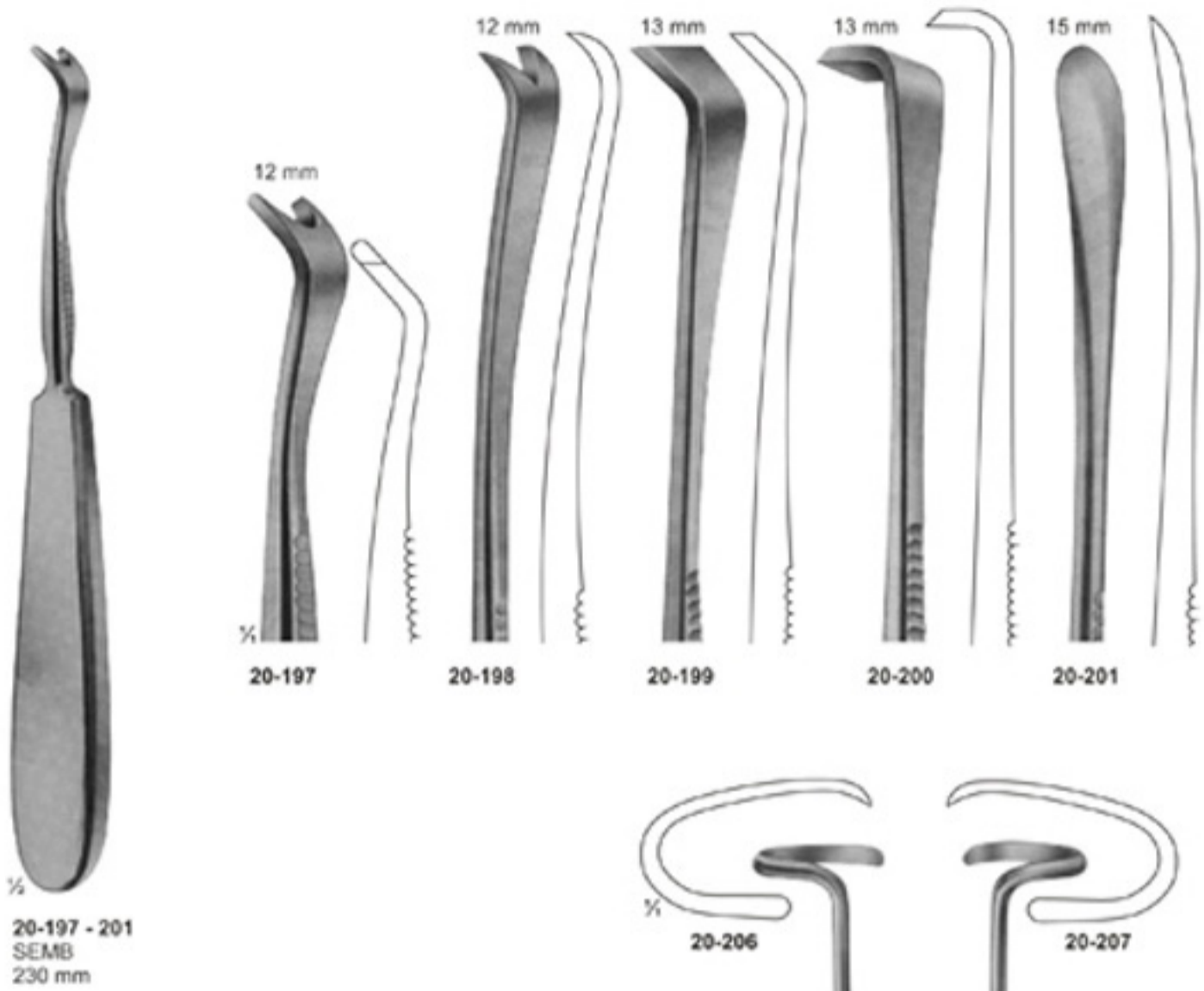



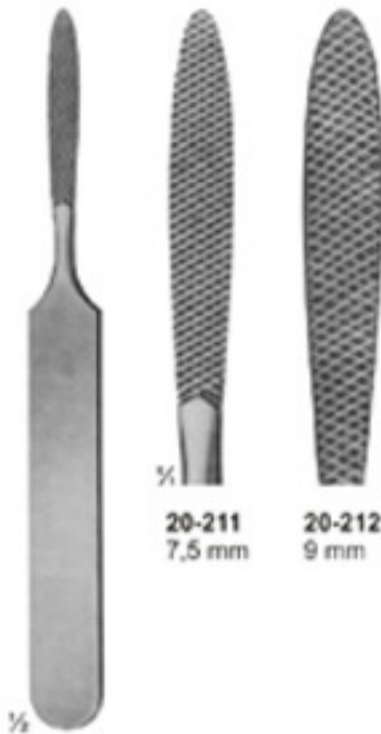

20-211
7,5 mm

20-212
9 mm

20-211
JOSEPH
fine, chequered

20-212
coarse, chequered
165 mm



20-215
9 mm

20-215
MALTZ
down stroke
180 mm

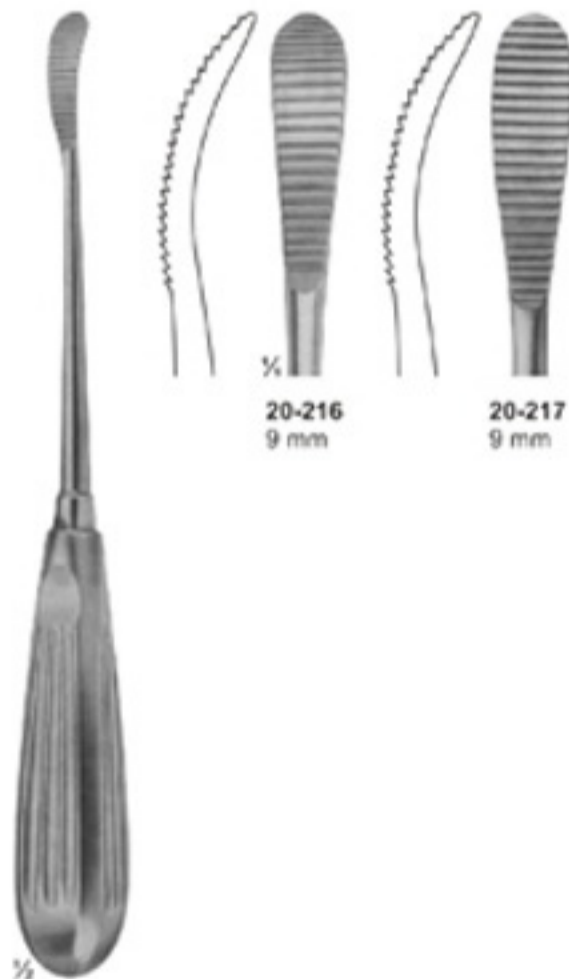

20-216
9 mm

20-217
9 mm

20-216
AUFRICHT
up stroke
20-217
down stroke
220 mm

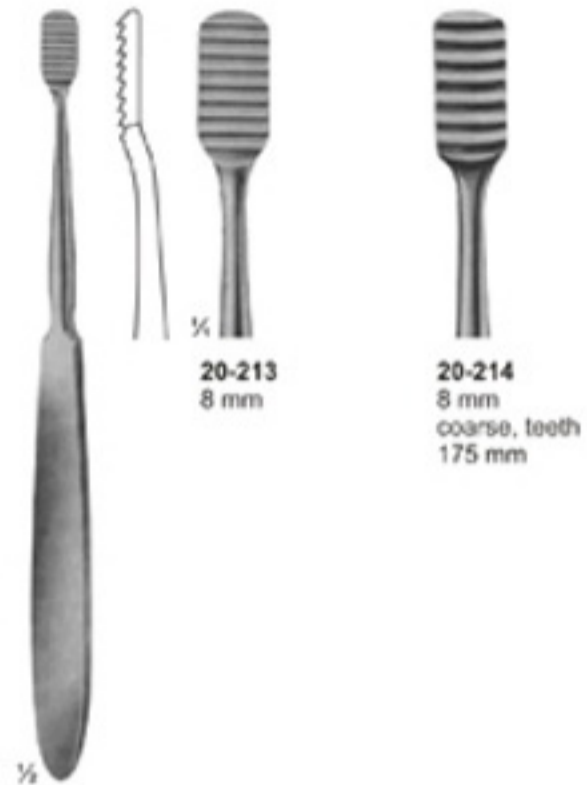

20-213
8 mm

20-214
8 mm
coarse, teeth
175 mm

20-213
LEWIS
fine, teeth



20-218
6,5 mm

20-218
GALLAHER
190 mm

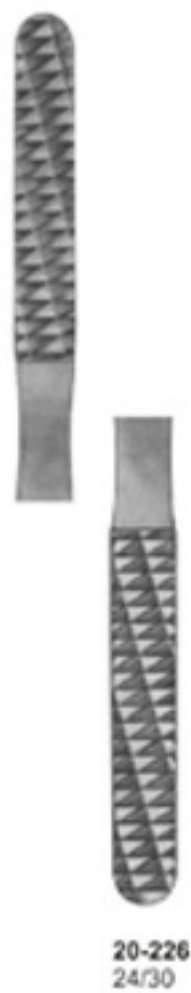
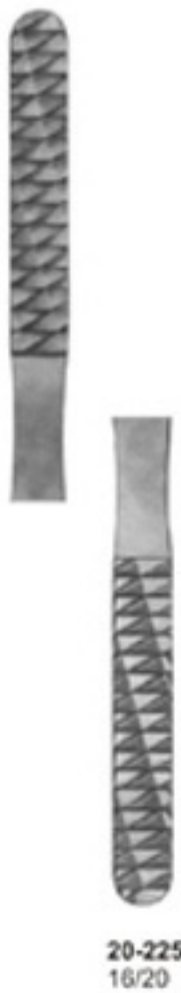
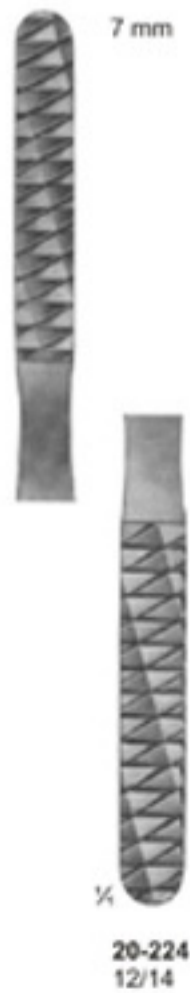
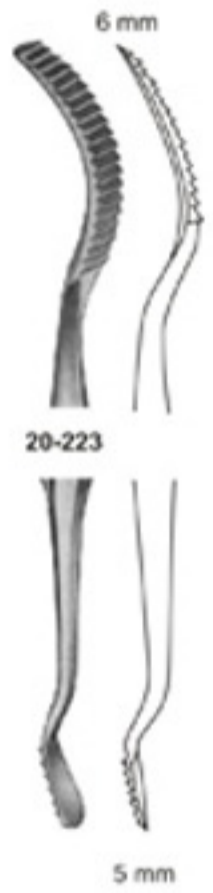
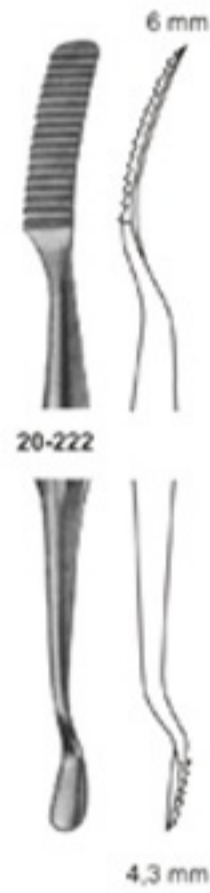
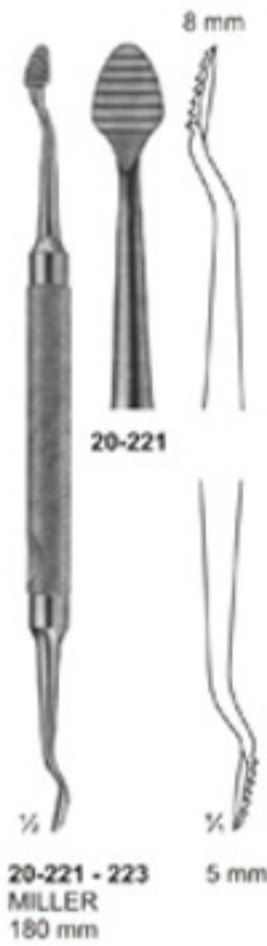
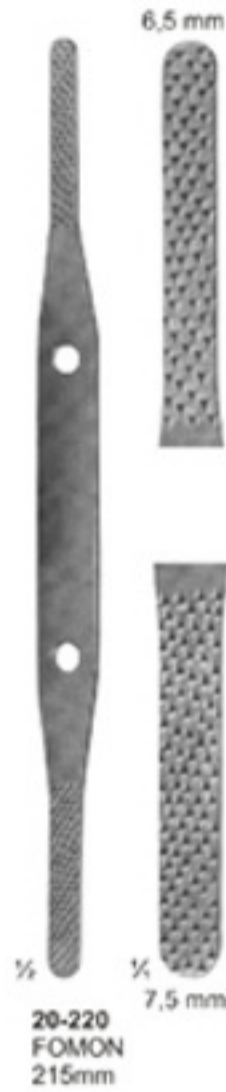

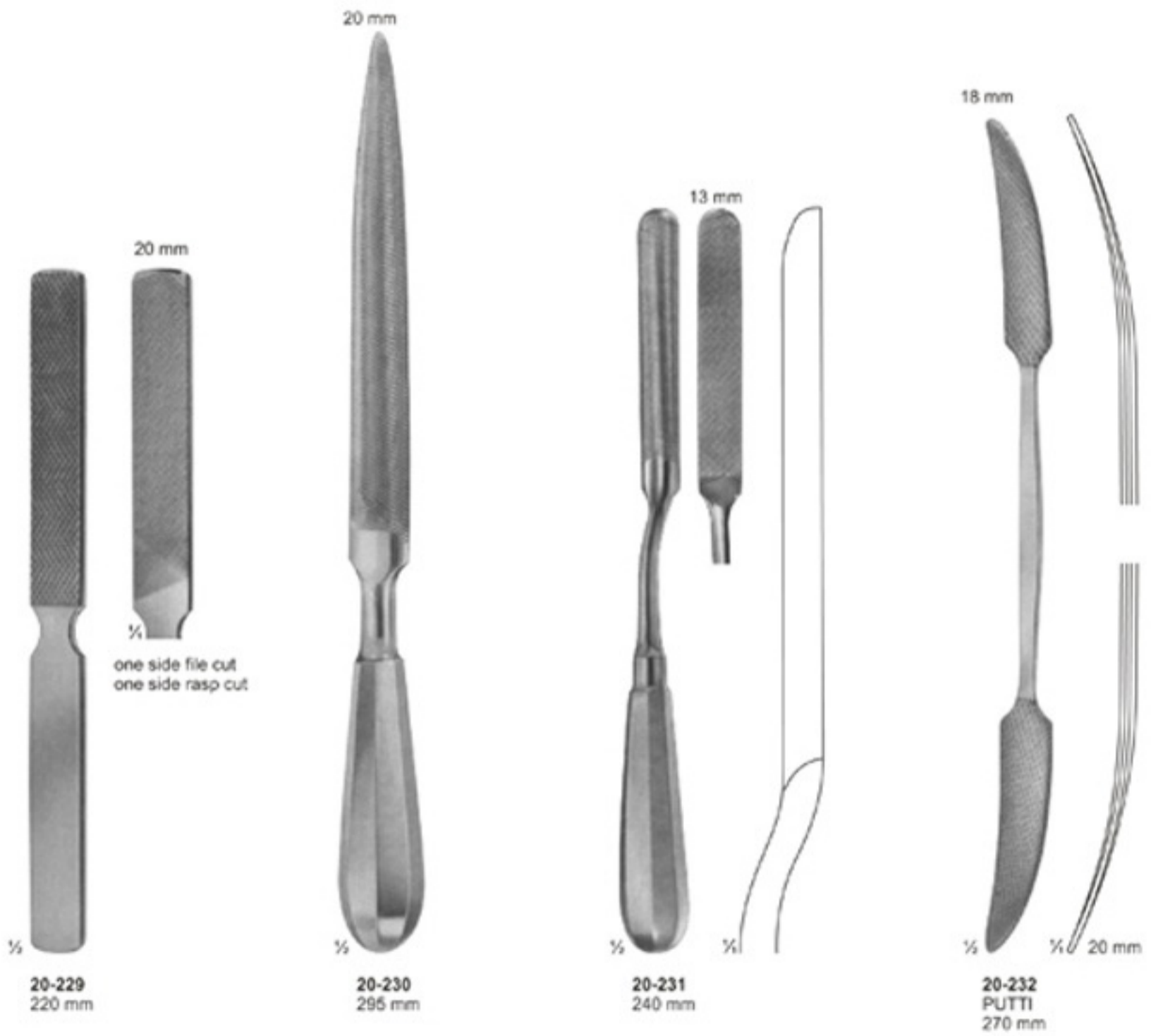



20-233
JACOBSON
140 mm



20-234
MARTINI
140 mm



20-235
MARTINI
140 mm



20-236
WILLIGER
145 mm



20-237
JANSEN
160 mm



20-238
BARTH
180 mm



20-239
VOLKMANN
130 mm

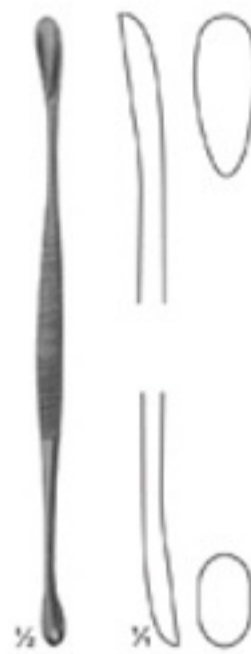

20-240
VOLKMANN
145 mm

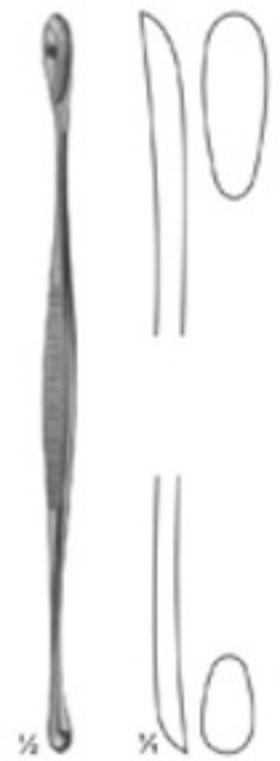

20-241
VOLKMANN
170 mm



20-242
JANSEN
160 mm



20-243
HEMINGWAY
170 mm



20-244
HEMINGWAY
175 mm



20-245
LUCAS
180 mm



20-246
LUCAS
185 mm

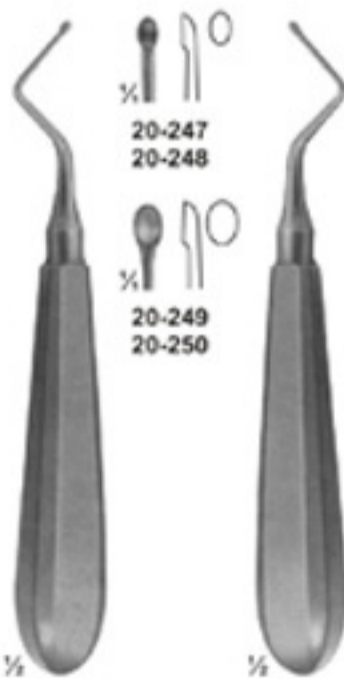

20-247 - 248
KERPEL
145 mm



20-249 - 250
KERPEL
145 mm

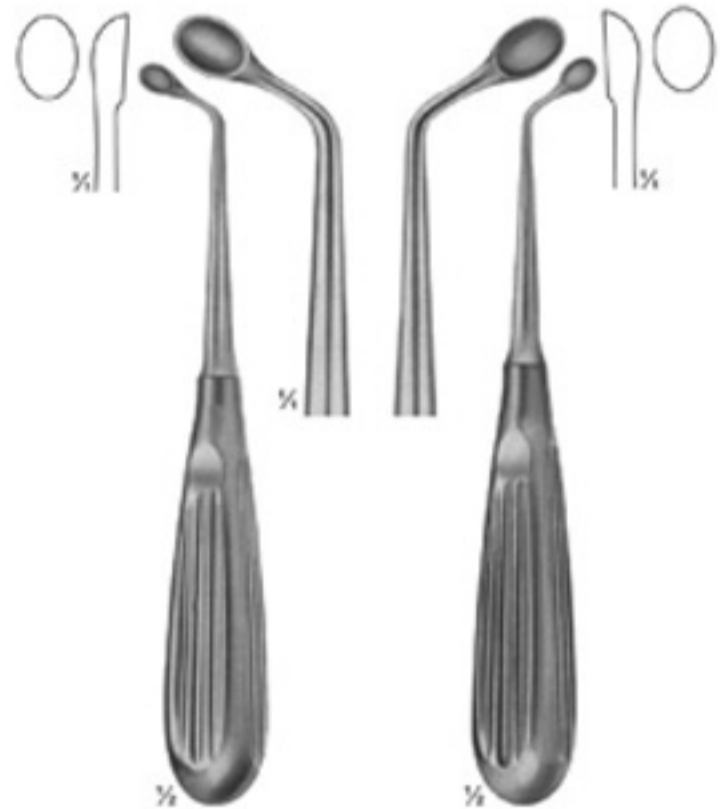

20-251
UFFENDORDE
170 mm

20-252
UFFENDORDE
170 mm



1/2

20-253 - 259
BRUNS
165 mm

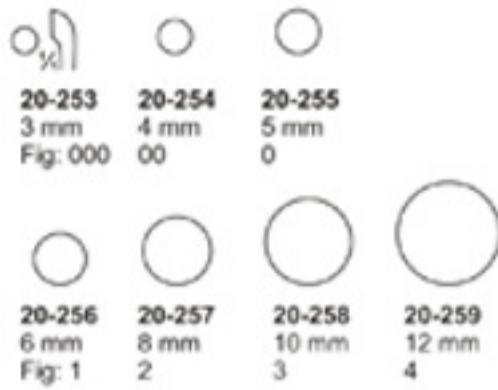

1/2

20-260 - 266
SCHEDE
170 mm

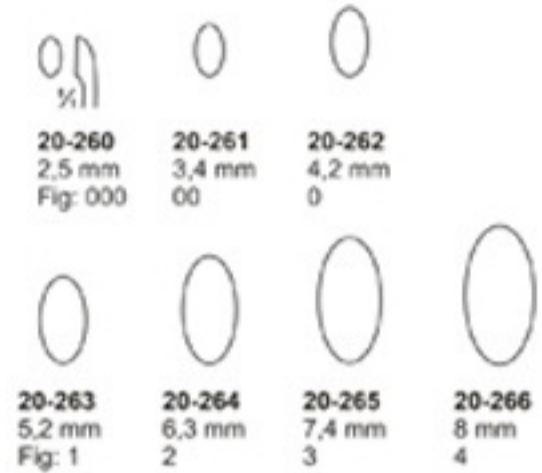

1/2

20-267 - 276
VOLKMANN
170 mm

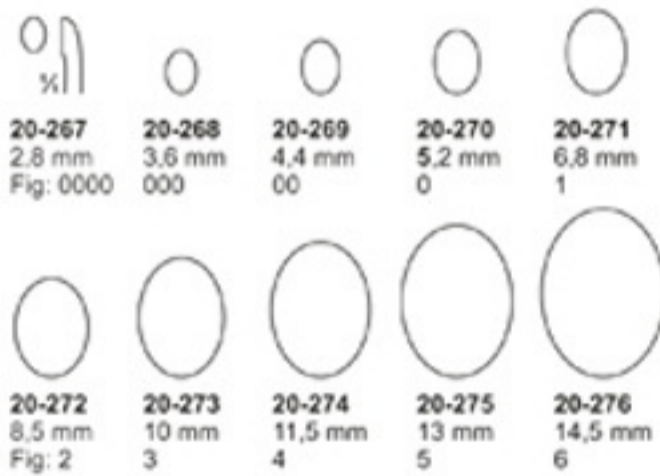

1/2

20-277 - 278
WILLIGER
170 mm



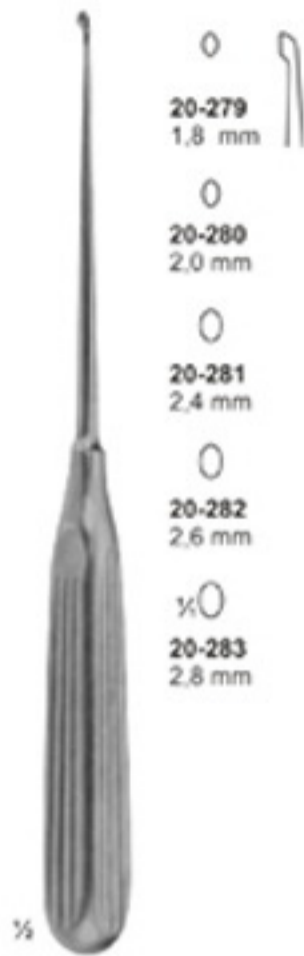

20-279
1,8 mm

20-280
2,0 mm

20-281
2,4 mm

20-282
2,6 mm

20-283
2,8 mm

1/2

20-279 - 283
LEMPERT
215 mm



20-284
4,4 mm
Fig: 00

20-285
5,2 mm
Fig: 0

20-286
6,8 mm
Fig: 1

1/2

20-284 - 286
HALLE
215 mm



20-287
4,4 mm
Fig: 0000

20-288
5,2 mm
Fig: 000

20-289
5,2 mm
Fig: 00

20-290
6,8 mm
Fig: 0

1/2

20-287 - 290
DAUBENSPECK
200 mm

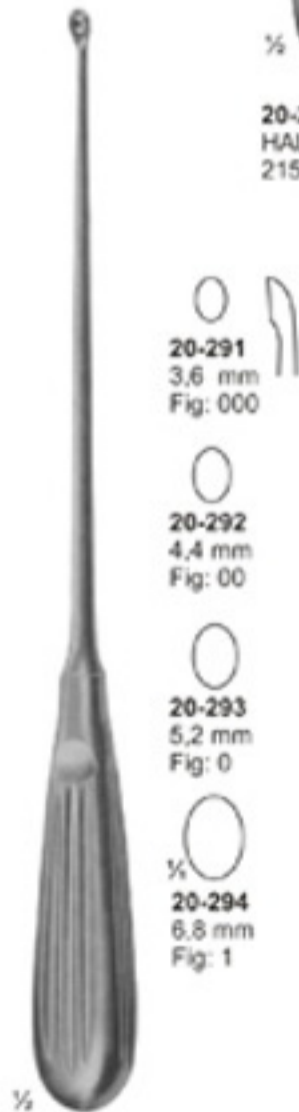

20-291
3,6 mm
Fig: 000

20-292
4,4 mm
Fig: 00

20-293
5,2 mm
Fig: 0

20-294
6,8 mm
Fig: 1

1/2

20-291 - 294
250 mm

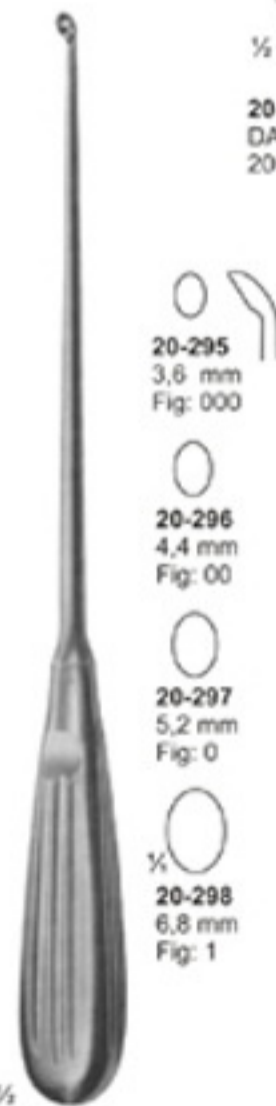

20-295
3,6 mm
Fig: 000

20-296
4,4 mm
Fig: 00

20-297
5,2 mm
Fig: 0

20-298
6,8 mm
Fig: 1

1/2

20-295 - 298
250 mm

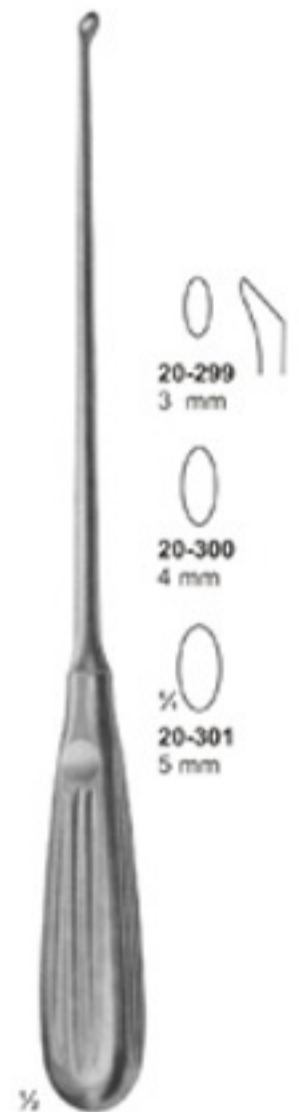

20-299
3 mm

20-300
4 mm

20-301
5 mm

1/2

20-299 - 301
BUSHE
250 mm

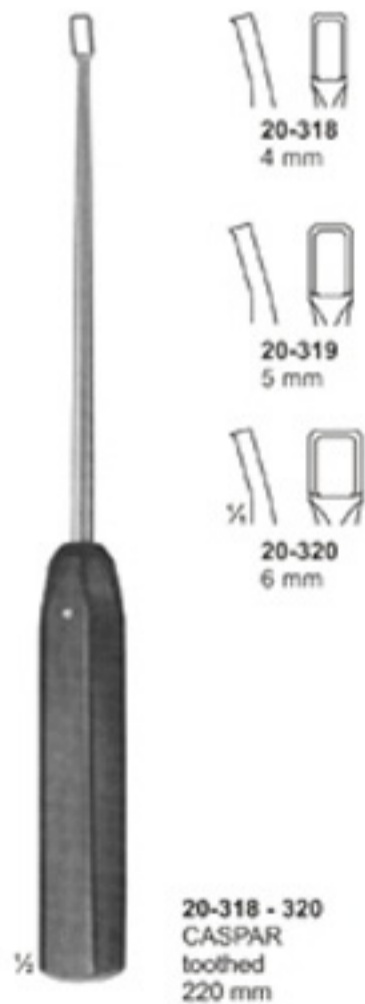
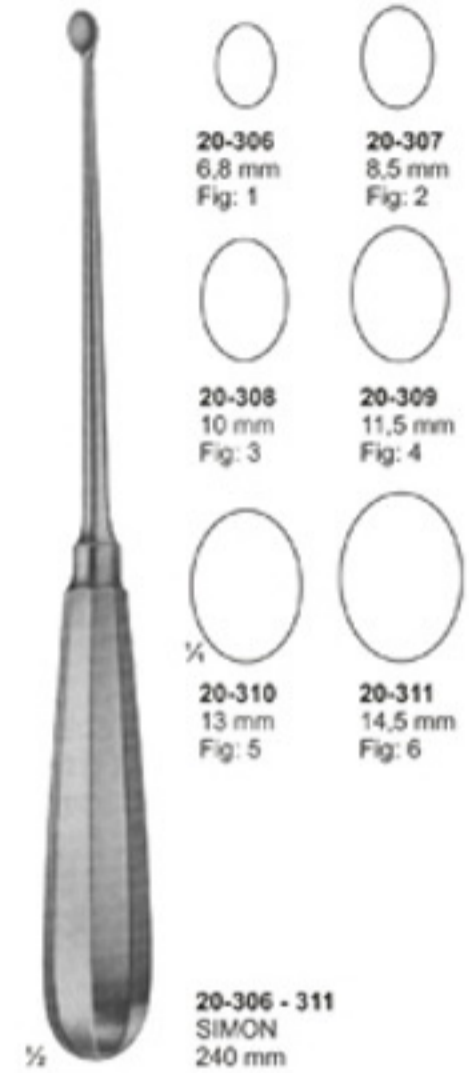

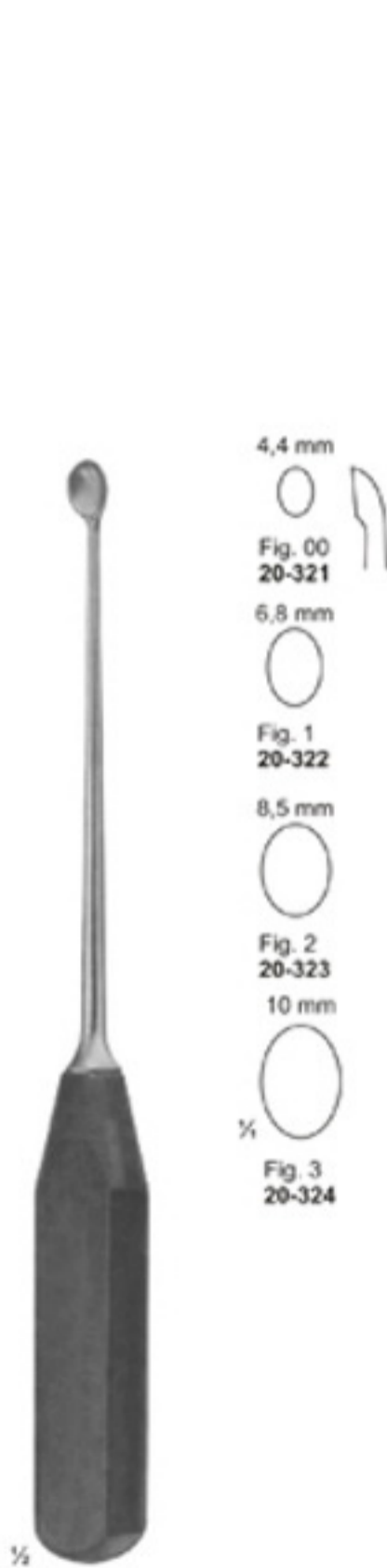

20-321 - 324
270 mm

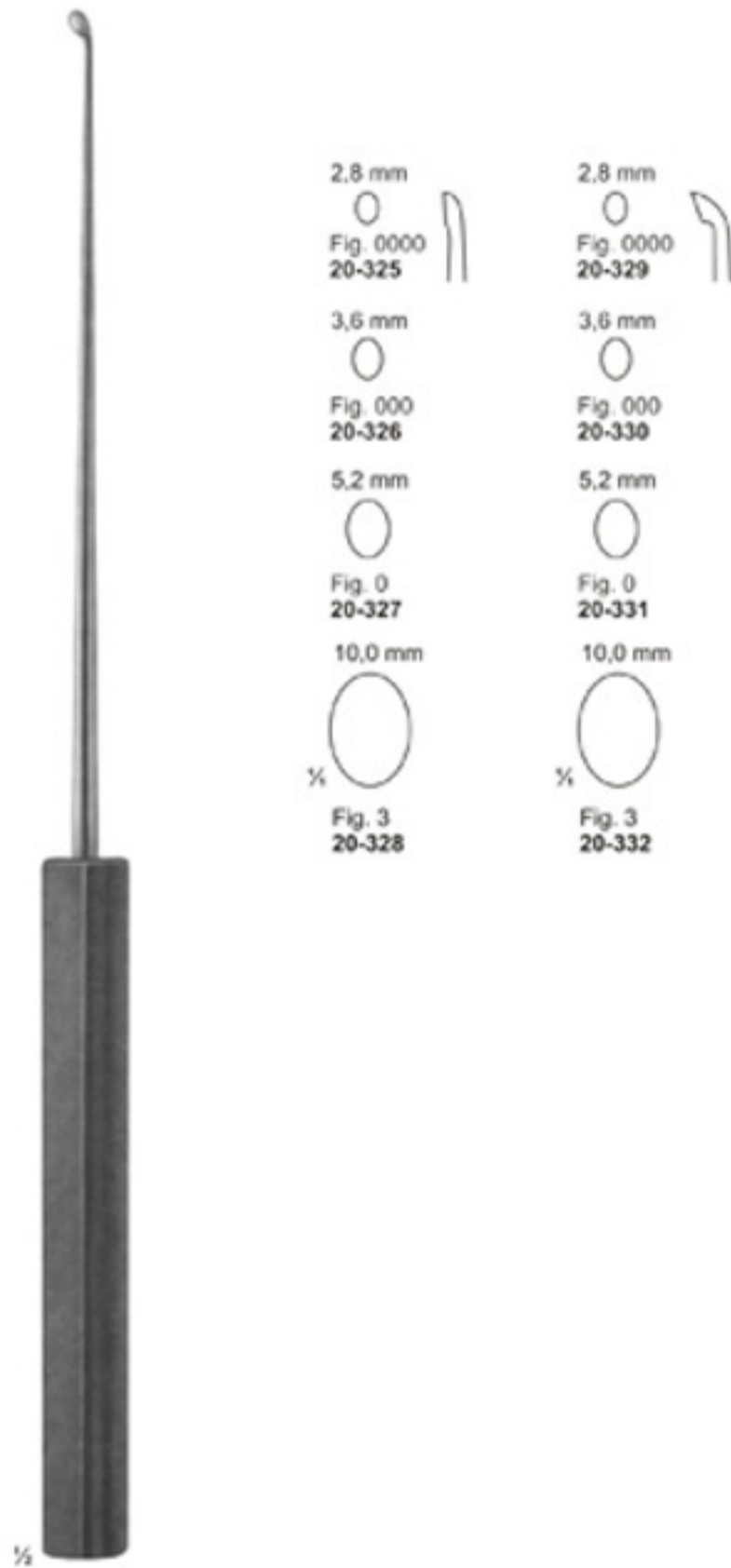

20-325 - 332
SYPERT
380 mm



21-101
MEAD
185 g
with interchangeable
plastic disks
190 mm
21-102
pair of spare disks



21-103
140 g
with interchangeable
plastic disks
185 mm
21-104
pair of spare disks



21-105
COTTLE
140 g
1 Seite convex
1 Side convex
185 mm



21-106
165 g
lead filled head
190 mm



21-107
HAJEK
140 g
215 mm



21-108
215 g
with interchangeable
plastic disks
245 mm
21-109
pair of spare disks



21-110 - 113
WAGNER
complete with:
1 pair of metal disks and
1 pair of plastic disks and
1 wrench 566
235 mm



21-111
1 metal disks, flat
1 metal disks, convex

21-112
1 plastic disks, flat
1 plastic disks, convex



21-113
Wrench

Mallet without disks 130 g



21-114
BERGMANN
245 mm



21-115
BERGMANN
235 mm



21-116
OMBREDANNE
240 mm



21-117
HEATH
copper filled head
700 g
185 mm



21-118
Haase
100 mm

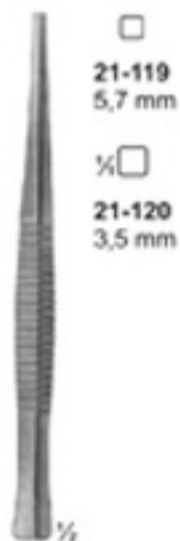

21-119 - 120
PASSOW
120 mm



21-121 - 123
CASPER
200 mm

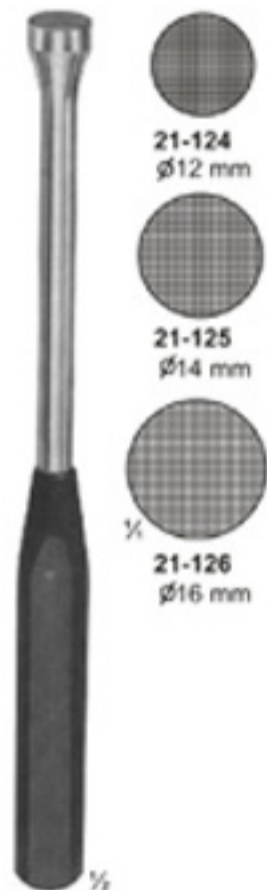

21-124 - 126
200 mm

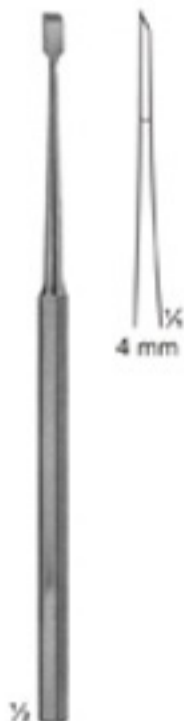

21-127
FREER
Chisel
160 mm

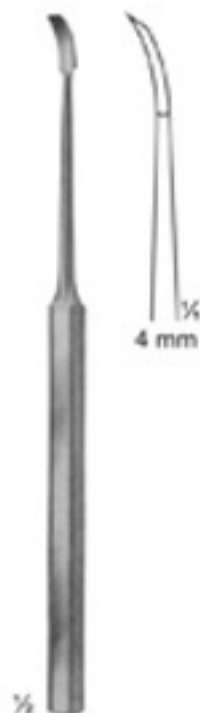

21-128
FREER
Chisel, curved
160 mm

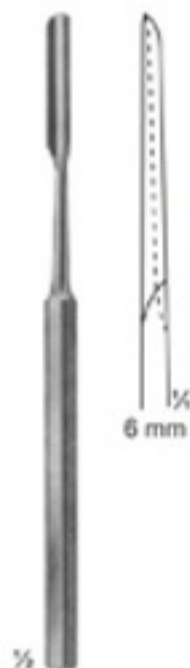

21-129
FREER
Gouge
150 mm

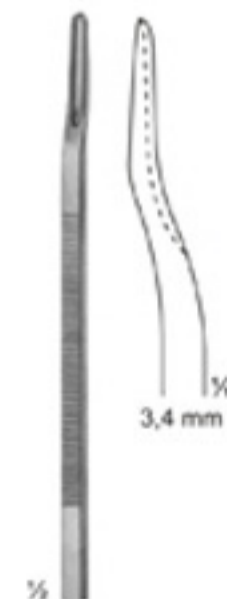

21-130
Scaphoid gouge,
downwards curved
135 mm

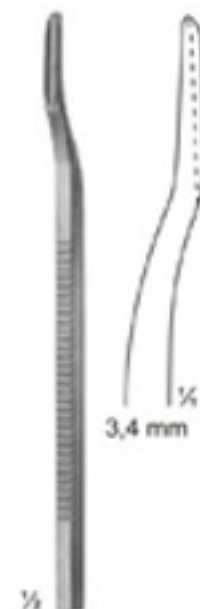

21-131
Scaphoid gouge,
upwards curved
135 mm



21-131A - 133
Mannerfelt
21-131A 4 mm
21-132 6 mm
21-133 8 mm
155 mm

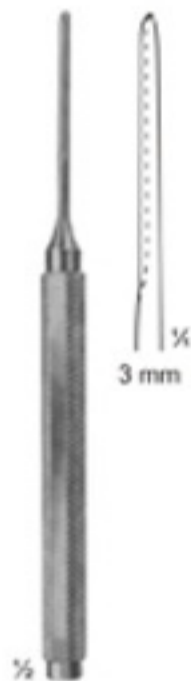

21-134
Mannerfelt
155 mm

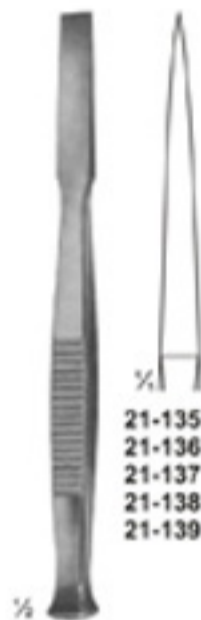

21-135 - 139
Osteotome
140 mm

21-135 4 mm
21-136 6 mm
21-137 8 mm
21-138 10 mm
21-139 12 mm

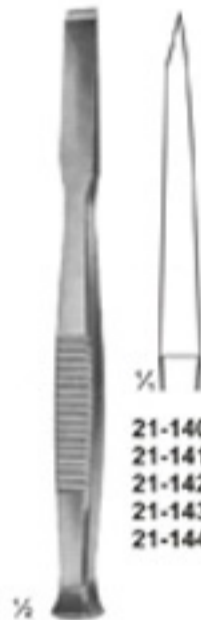

21-140 - 144
Chisels
140 mm

21-140 4 mm
21-141 6 mm
21-142 8 mm
21-143 10 mm
21-144 12 mm

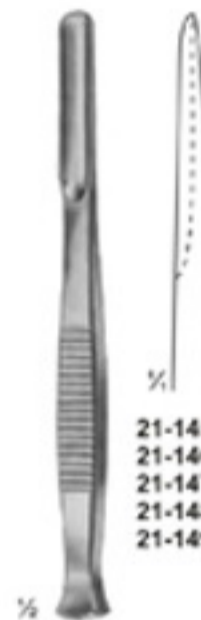

21-145 - 149
Gouges
140 mm

21-145 4 mm
21-146 6 mm
21-147 8 mm
21-148 10 mm
21-149 12 mm

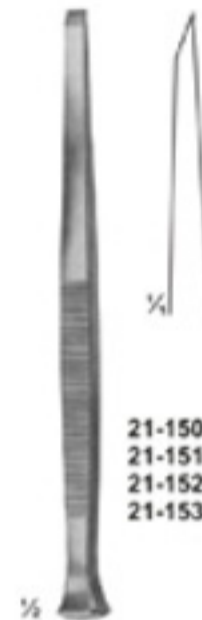

PARTSCH
21-150 - 153
Chisels
140 mm

21-150 3 mm
21-151 4 mm
21-152 5 mm
21-153 6 mm



PARTSCH
21-154 - 158
Chisels
170 mm

21-154 3 mm
21-155 4 mm
21-156 5 mm
21-157 6 mm
21-158 7 mm

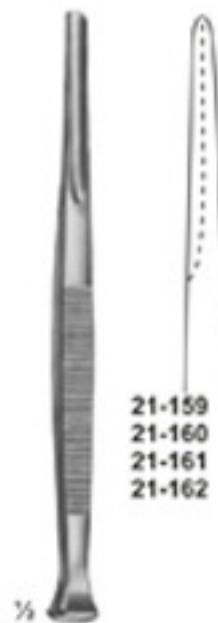

PARTSCH
21-159 - 162
Gouges
140 mm

21-159 3 mm
21-160 4 mm
21-161 5 mm
21-162 6 mm

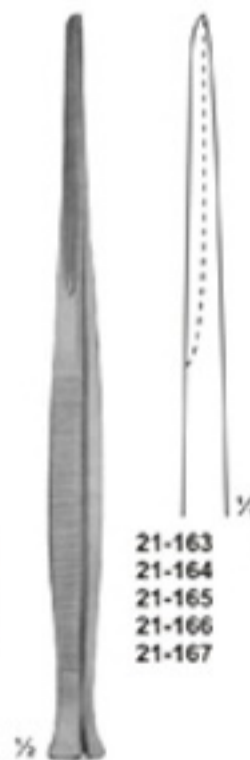

PARTSCH
21-163 - 167
Gouges
170 mm

21-163 3 mm
21-164 4 mm
21-165 5 mm
21-166 6 mm
21-167 7 mm



LUCAS
21-168 - 169
Chisels
160 mm

21-168 4 mm
21-169 6 mm

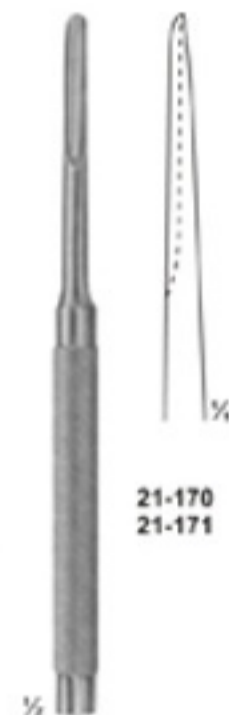

LUCAS
21-170 - 171
Gouges
160 mm

21-170 3 mm
21-171 5 mm

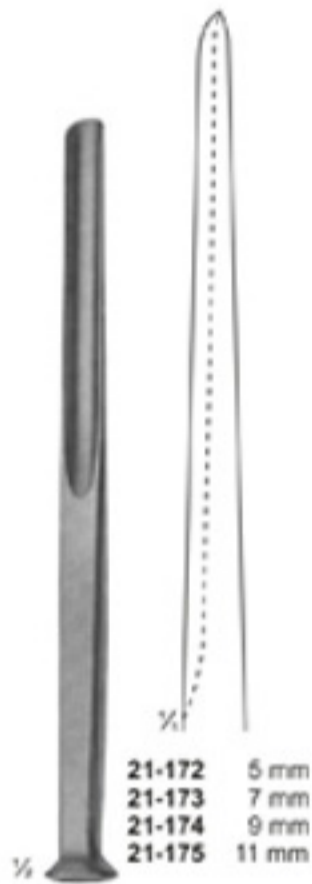

21-172 5 mm
21-173 7 mm
21-174 9 mm
21-175 11 mm

ALEXANDER
21-172 - 175
Gouges
170 mm



21-176 4 mm
21-177 6 mm
21-178 8 mm
21-179 10 mm
21-180 12 mm
21-181 15 mm

LAMBOTTE
21-176 - 181
Osteotome
125 mm

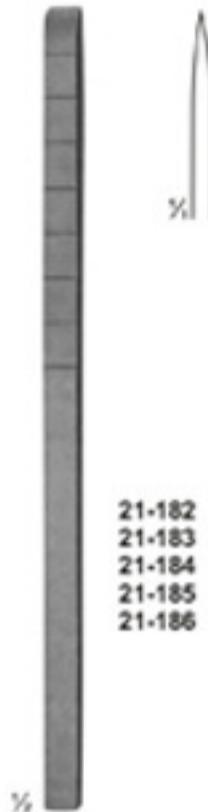

21-182 4 mm
21-183 6 mm
21-184 8 mm
21-185 10 mm
21-186 12 mm

COTTLE
21-182 - 186
Osteotome with depth
markings
180 mm



21-187 4 mm
21-188 7 mm
21-189 9 mm
21-190 12 mm

COTTLE
21-187 - 190
Chisel-Osteotomes
with depth markings
180 mm

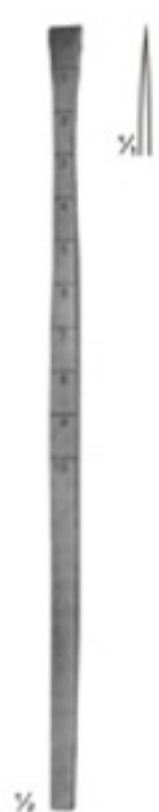

COTTLE
21-191
Fishtail Chisel,
with protected ends
180 mm



21-192 10 mm
21-193 12 mm
21-194 15 mm
21-195 20 mm
21-196 25 mm

STILLE
21-192 - 196
Chisels
205 mm

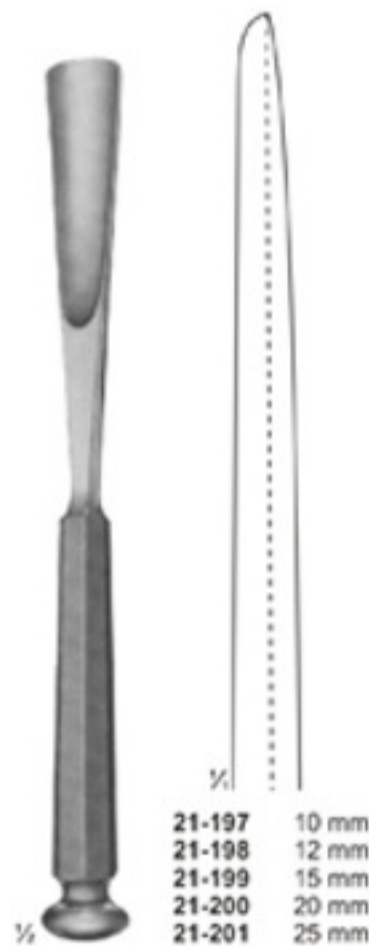

21-197 10 mm
21-198 12 mm
21-199 15 mm
21-200 20 mm
21-201 25 mm

STILLE
21-197 - 201
Gouges
205 mm

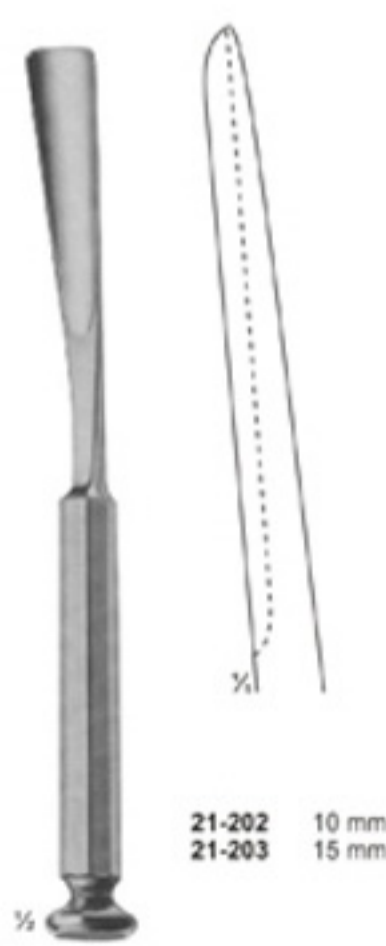

21-202 10 mm
21-203 15 mm

WALTER
21-202 - 203
Osteotomes
gouges for taking
grafts from the rib
205 mm



21-204 8 mm
21-205 12 mm
21-206 15 mm
21-207 20 mm
21-208 25 mm

STILLE
21-204 - 208
Osteotomes
205 mm



STILLE
21-209 - 213
Osteotomes
205 mm

STILLE
21-214 - 218
Osteotomes, curved
205 mm

LAMBOTTE
21-219 - 230
Osteotomes
245 mm

LAMBOTTE
21-231 - 236
Osteotomes, curved
245 mm

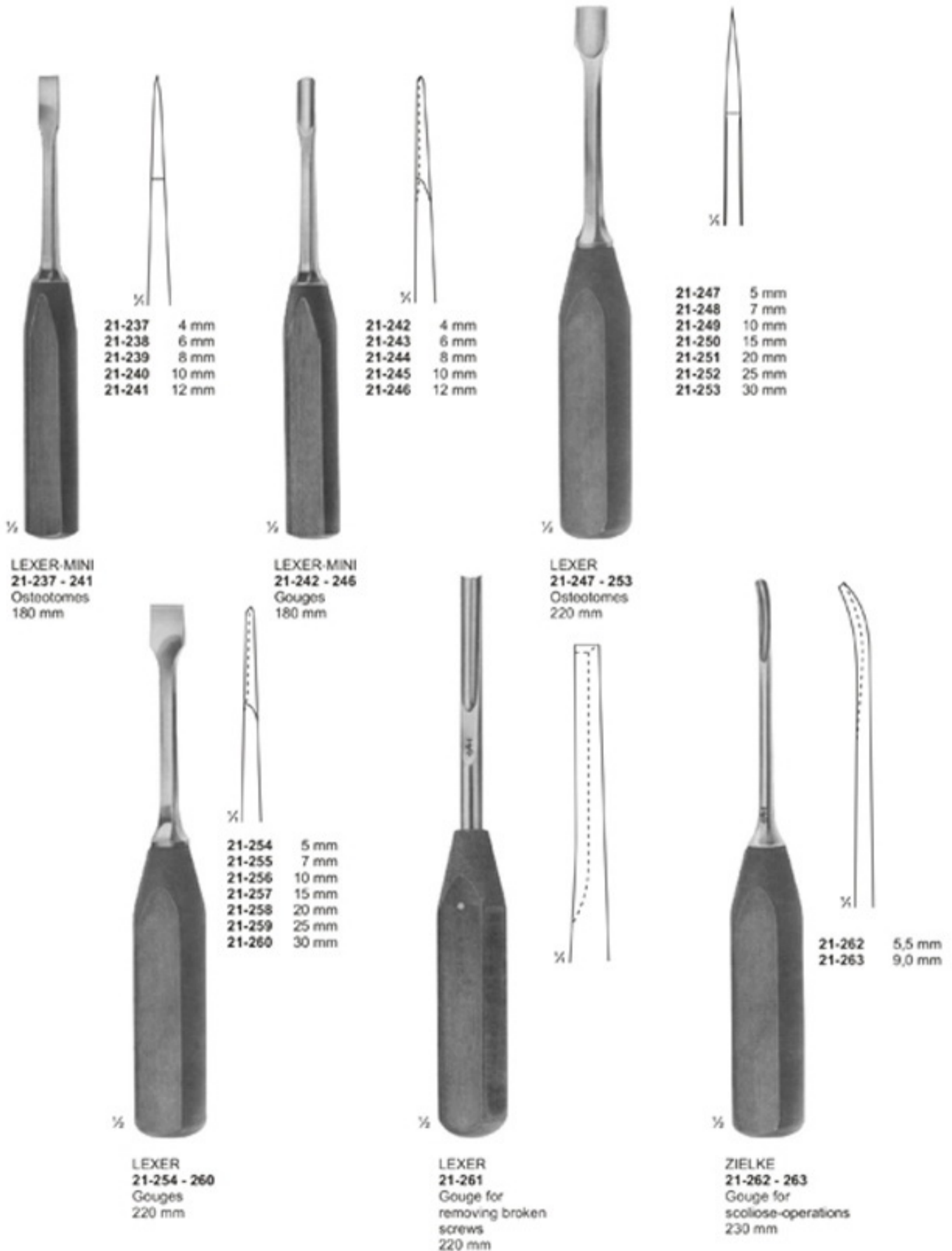

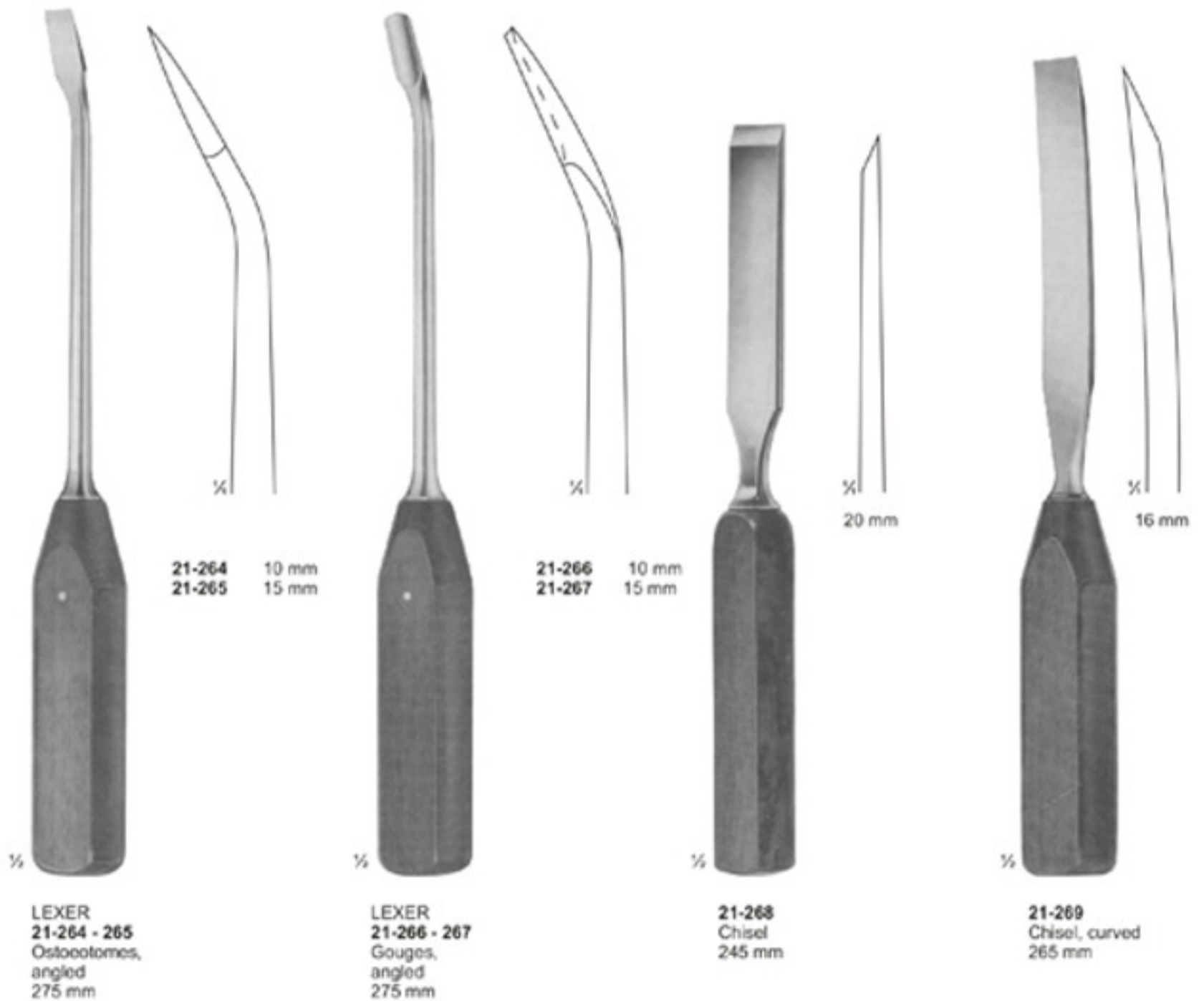



22-101
Reposition forceps,
for small fragments
135 mm



HAASE
22-102
Reposition forceps,
for mandibular
fractures
165 mm



REILL
22-103
Reposition forceps,
170 mm



22-104
Reposition forceps
205 mm



MEYER
22-105
Reposition forceps
for fingers, with drill
guide for KIRSCHNER
wires up to daim. 1.0 mm
170 mm



22-106
Patella forceps
185 mm



22-107
Forceps with
ratchet fixation
140 mm



22-108
Forceps with
thread fixation
170 mm



22-109
Forceps with
thread fixation
235 mm

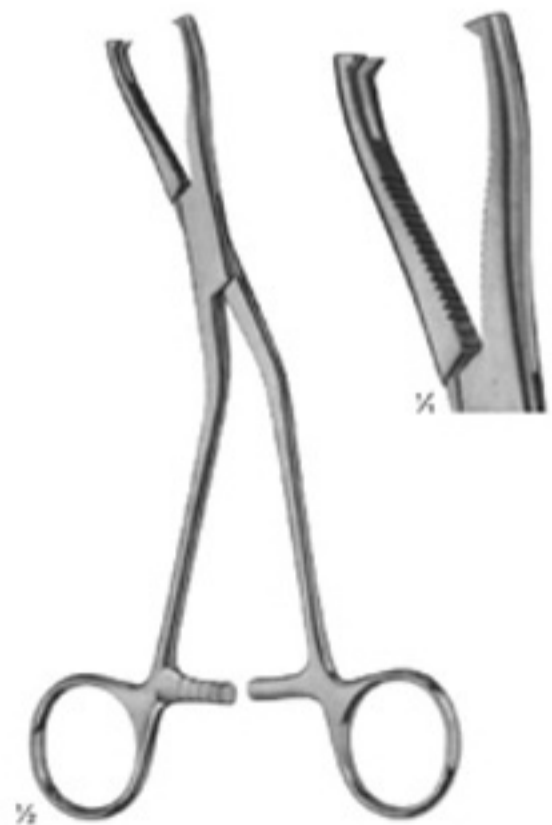

22-110
DINGMANN
185 mm



22-111
Sequestrum
forceps
200 mm



22-112
VAN BUREN
Sequestrum
forceps
225 mm



22-113
LANGENBECK
Sequestrum
forceps
205 mm



22-114
FERGUSSON
205 mm

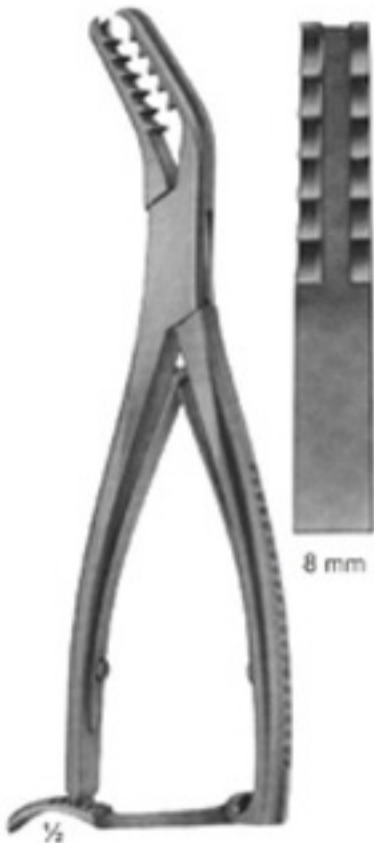
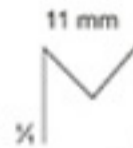
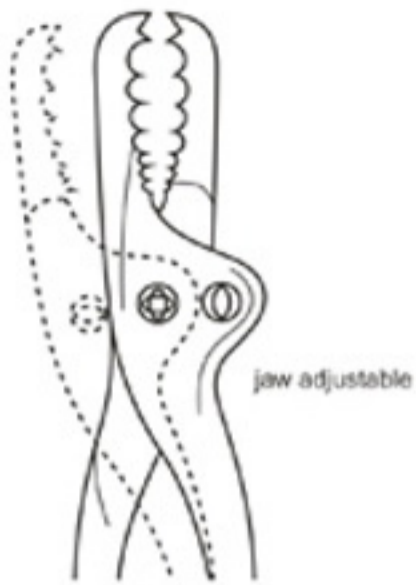

22-115
SEMB
190 mm



22-116
FARABEUF
230 mm



22-117
FARABEUF
255 mm



22-118
FARABEUF-LAMBOTTE
255 mm







22-124 - 128

- 22-124 145 mm
- 22-125 190 mm
- 22-126 240 mm
- 22-127 260 mm
- 22-128 280 mm

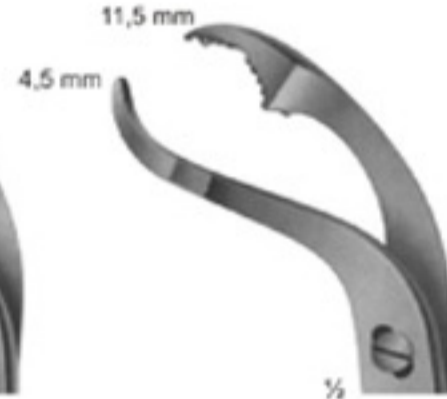
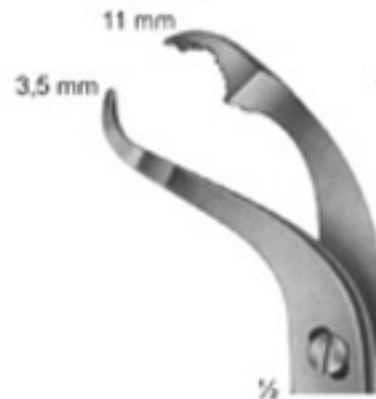
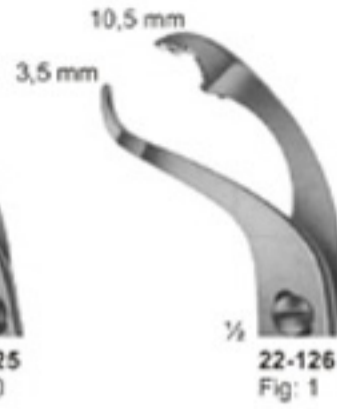

Self-centering forceps with thread fixation



22-129 - 131
VERBRUGGE
with lip joint



22-132
LAMBOTTE
265 mm



22-133 - 134
LOWMAN
22-133 170 mm
22-134 205 mm



22-135
LOWMAN-GERSTER
210 mm



22-136
LOWMAN-HOGLUND
175 mm



22-137 - 138
Synovectomy rongeur
width of jaws 1.2 mm
130 mm



22-139 - 140
Synovectomy rongeur
width of jaws 2.0 mm
130 mm



22-141
STELLBRINK
Synovectomy rongeur
175 mm



22-142
STELLBRINK
Synovectomy rongeur
170 mm



22-143
LURE-FRIEDMANN
145 mm



22-144
140 mm



22-145
LURE
150 mm



22-146
LURE
155 mm



22-147
BLUMENTHAL
155 mm



22-148
BLUMENTHAL
150 mm



22-149 - 150
JANSEN
175 mm

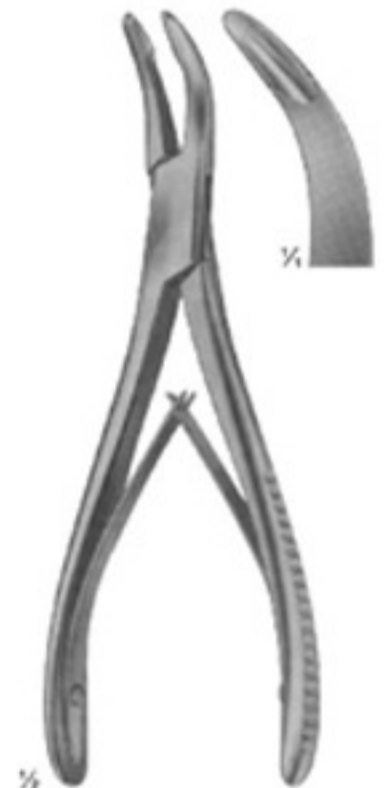

22-151
BANE-HARTMANN
175 mm



22-152
ALEXANDER
140 mm



22-153
JANSEN
190 mm

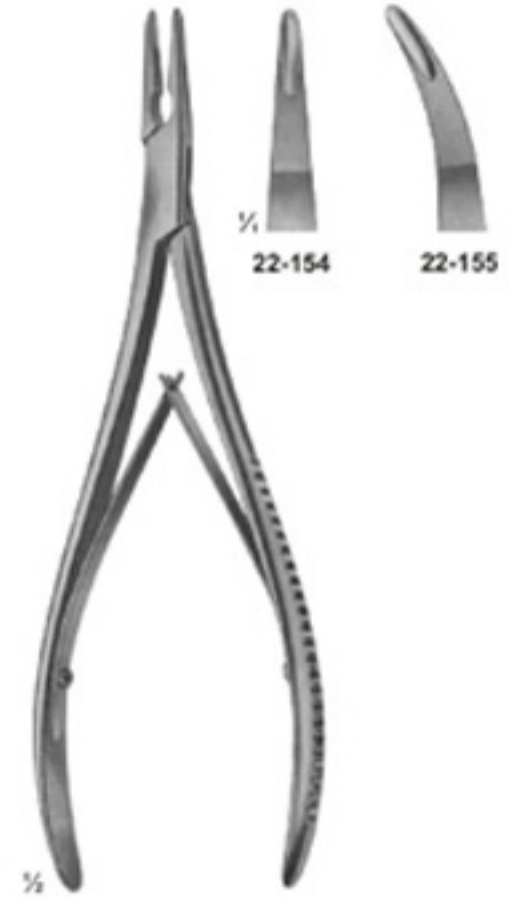

22-154 - 155
LEMPERT
200 mm

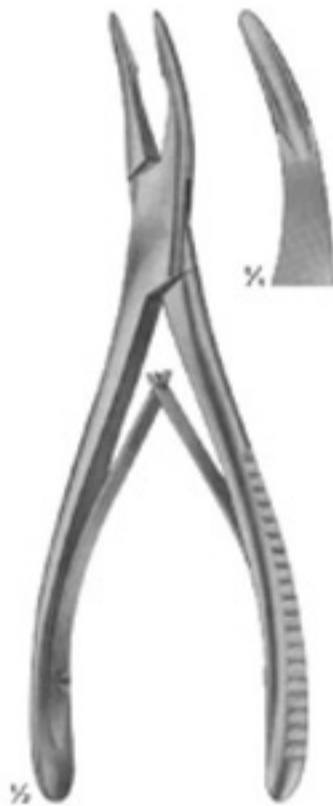

22-156
BEYER
180 mm



22-157
MEAD
165 mm



22-158
MEAD
165 mm

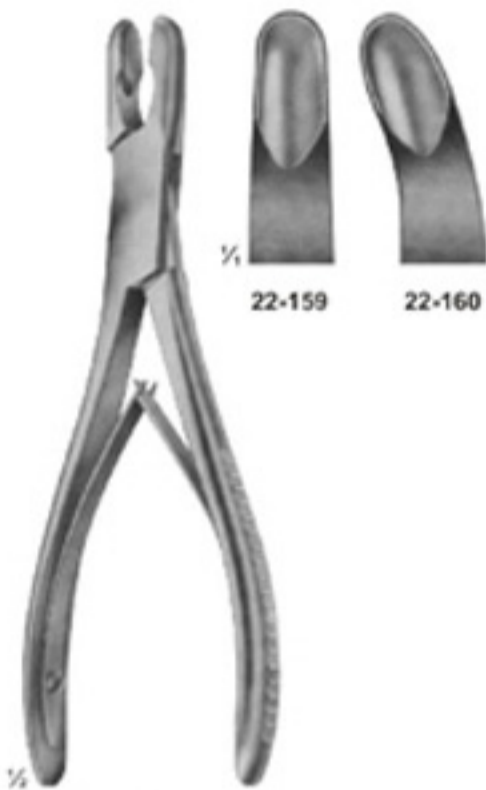

22-159 - 160
LURE
175 mm



22-161
LURE
180 mm



22-162
LURE
180 mm



22-163
OLIVECRONA
205 mm



22-164 - 165
BOHLER
155 mm



22-166
MARQUARTD
200 mm



22-167
RUSKIN
190 mm



22-168
ROTTGEN-RUSKIN
240 mm

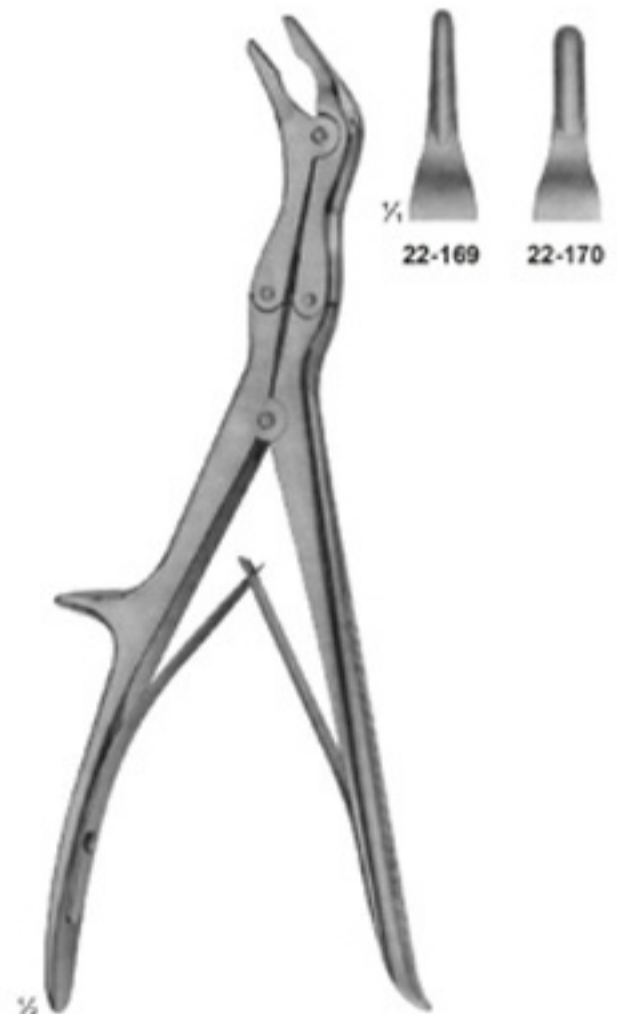

22-169 - 170
ECHLIN
230 mm



22-171
STILLE
235 mm



22-172
LEKSELL-STILLE
240mm



22-173
STILLE-RUSKIN
240mm



22-174
LURE-STILLE
225 mm



22-175
LURE-STILLE
225 mm

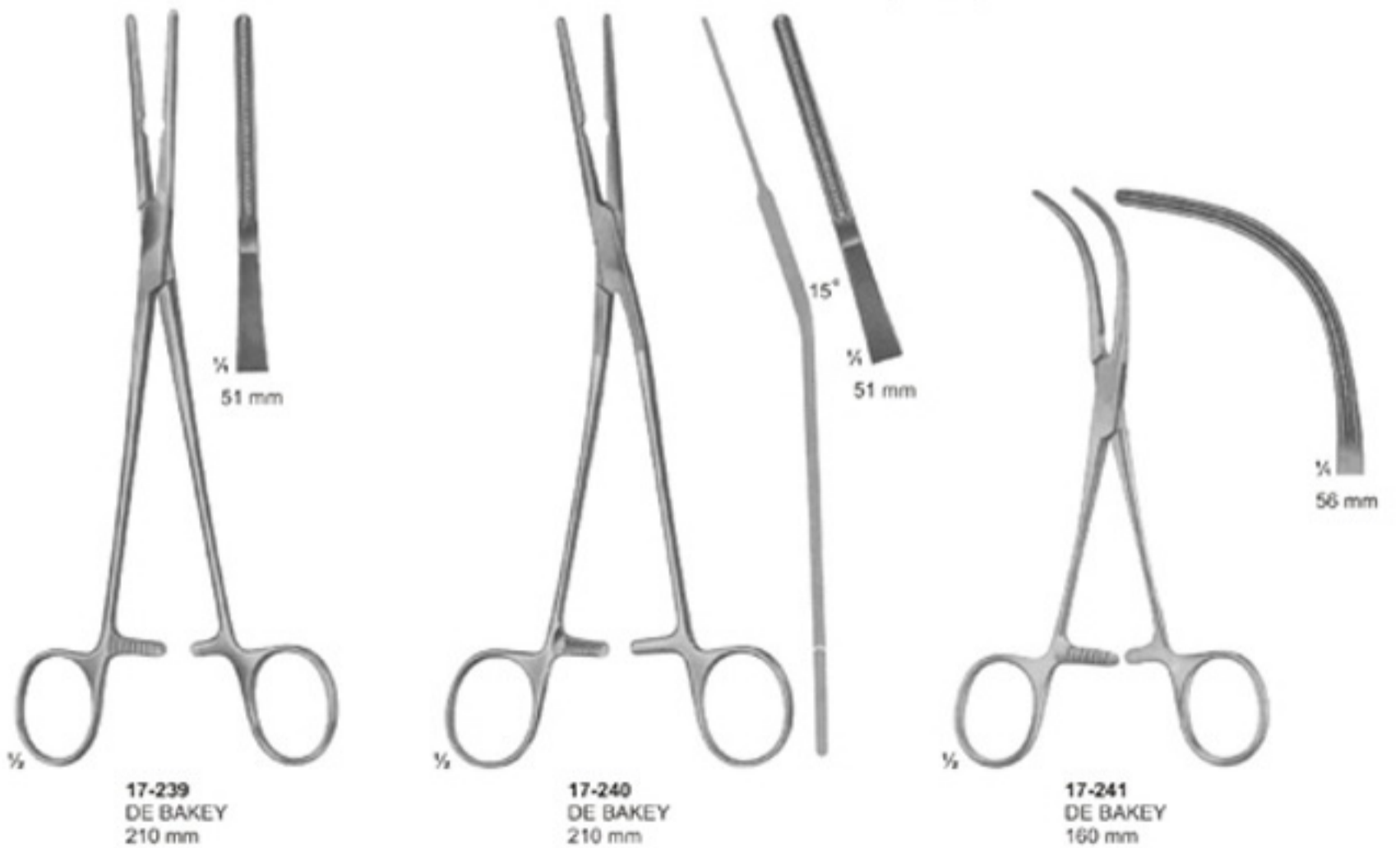
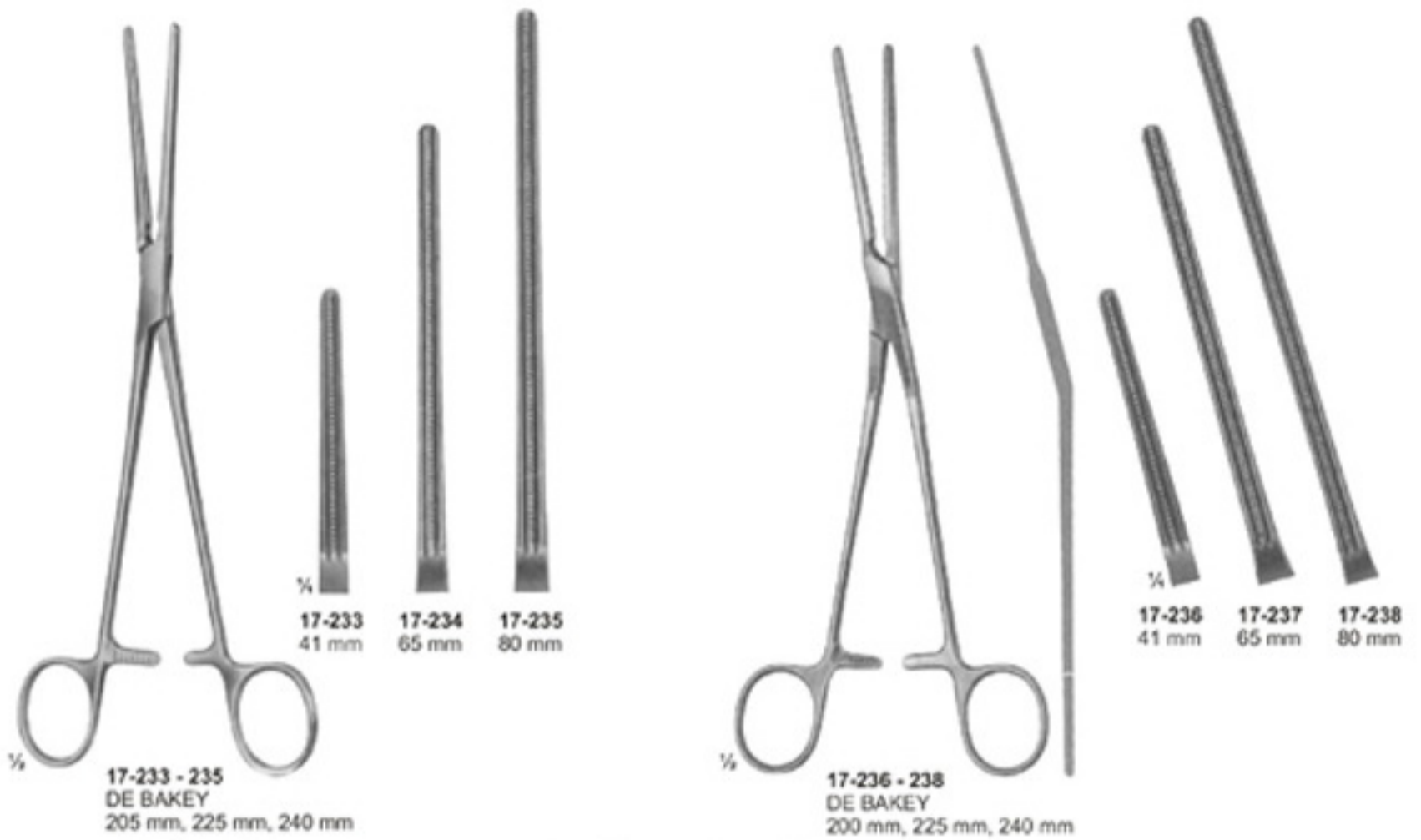



22-178
STAMM
150 mm



22-179
KAZANJIAN
185 mm



22-180 - 183
LISTON



22-180
140 mm



22-181
170 mm



22-183
220 mm



22-182
200 mm



22-184 - 186
LISTON



22-184
170 mm

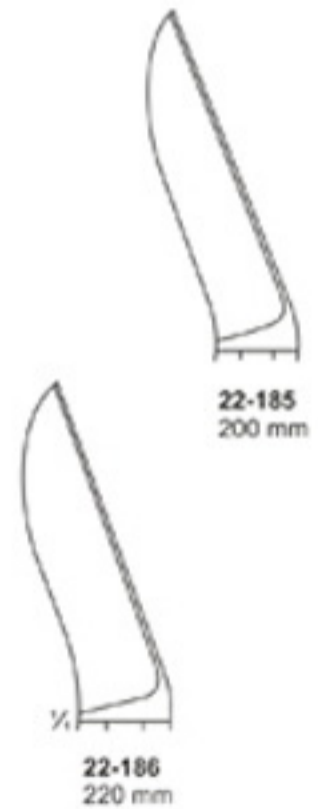

22-185
200 mm

22-186
220 mm



22-187
BOHLER
145 mm



22-188
RUSKIN-LISTON
190 mm

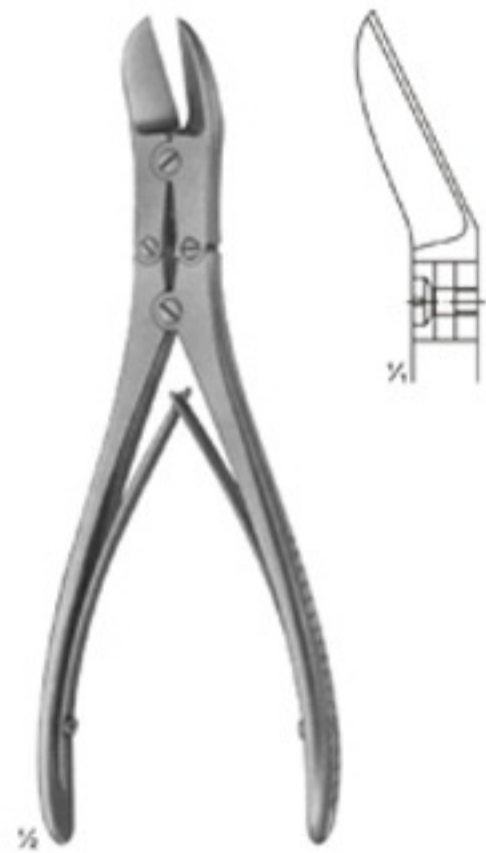

22-189
RUSKIN-LISTON
190 mm



22-190
LISTON
curved on flat
240 mm



22-191
LISTON
straight
280 mm

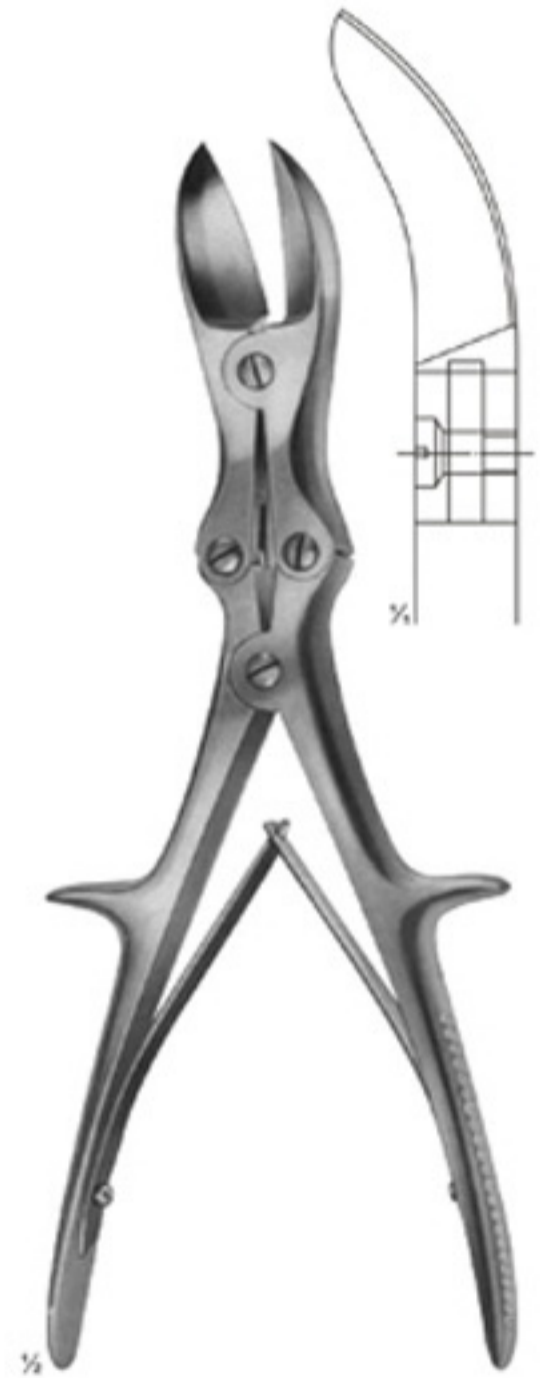

22-192
LISTON
curved on flat
280 mm



22-193
LISTON-STILLE
265 mm

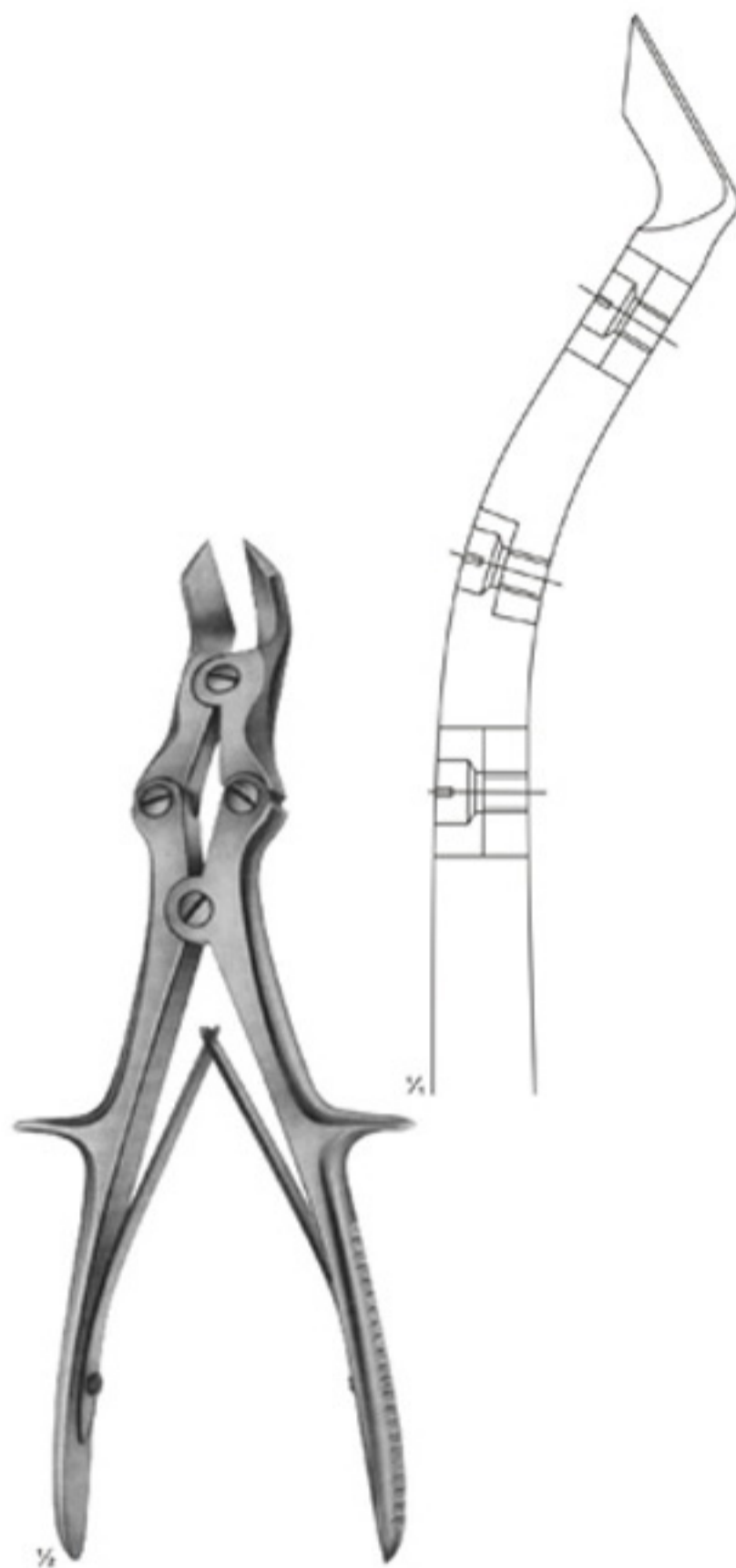

22-194
LISTON-KEY-HORSLEY
(TUDOR EDWARDS)
255 mm



22-195
BIRCHER
200 mm



22-196
BIRCHER
200 mm



22-197
WELLER
200 mm



22-198
BIRCHER-GANSKE
200 mm



22-199
BIRCHER-GANSKE
200 mm



22-200
MARTIN
205 mm



22-201
170 mm



22-202
NEFF
215 mm



22-203
NEFF
215 mm



22-204
WAGNER
215 mm



22-205
SALENIUS
220 mm



22-206
CHNAD.MODELL
200 mm

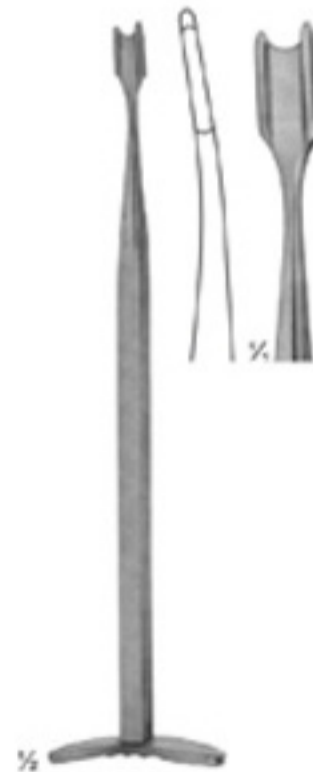

22-207
SMILLIE
170 mm

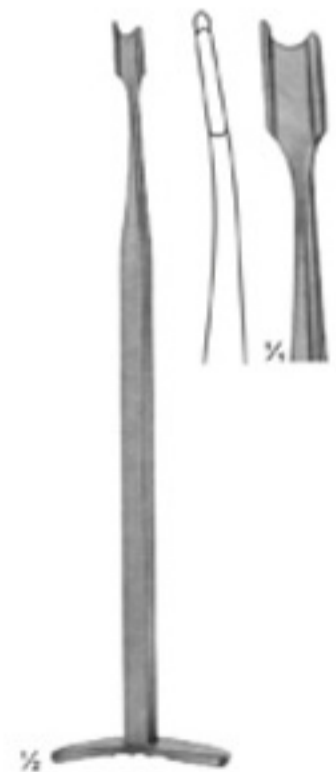

22-208
SMILLIE
170 mm

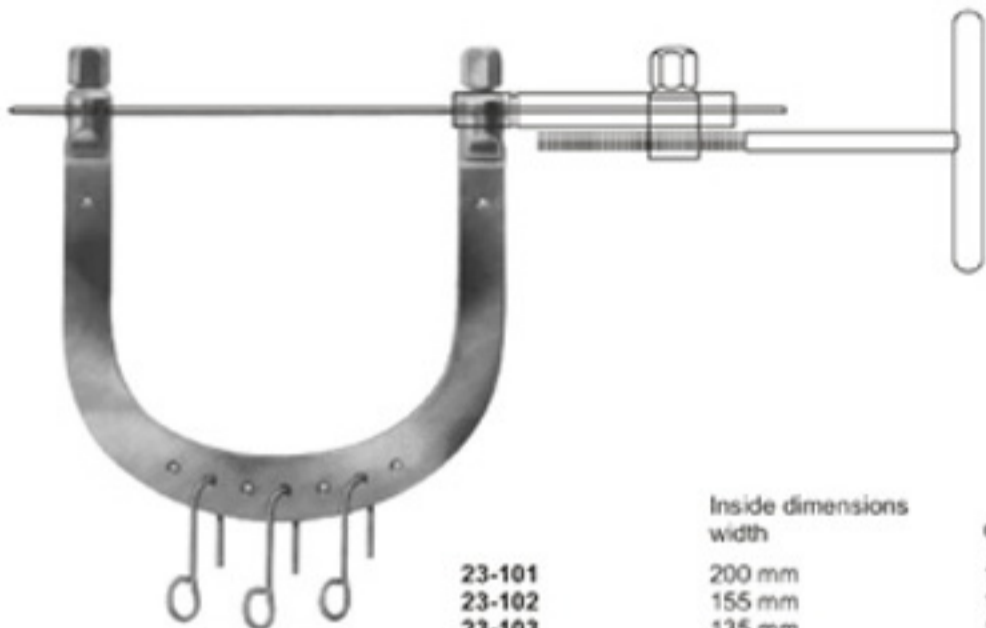

23-101 - 107
KIRSCHNER
 Wire traction bows,
 to be used with
 KIRSCHNER-wires
 up to 2.5 mm diam.,
 With 3 hooks,
 stainless steel

23-101
23-102
23-103
23-104
23-105
23-106
23-107

Inside dimensions
 width

200 mm
 155 mm
 135 mm
 120 mm
 105 mm
 95 mm
 95 mm

depth

155 mm
 155 mm
 130 mm
 120 mm
 100 mm
 110 mm
 70 mm



23-108
 Wrench, double - ended,
 for wire traction bows



23-109
 Wire tightener, with
 clamping jaws



23-110
 Traction hook only,
 large size



23-111
 Traction hook only,
 small size



23-112
 Fixation clamp, to secure clamping
 jaws of stainless steel

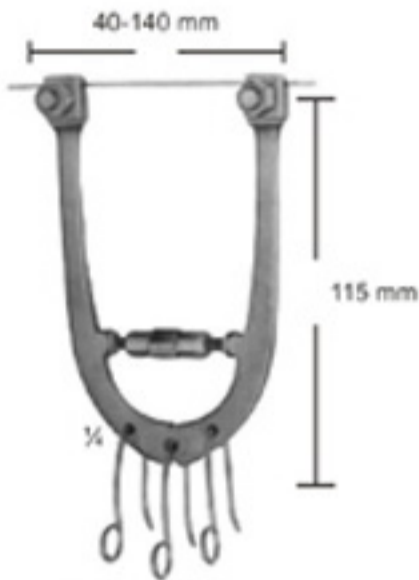

23-113
Wire traction bow, adjustable,
with 3 hooks, small size

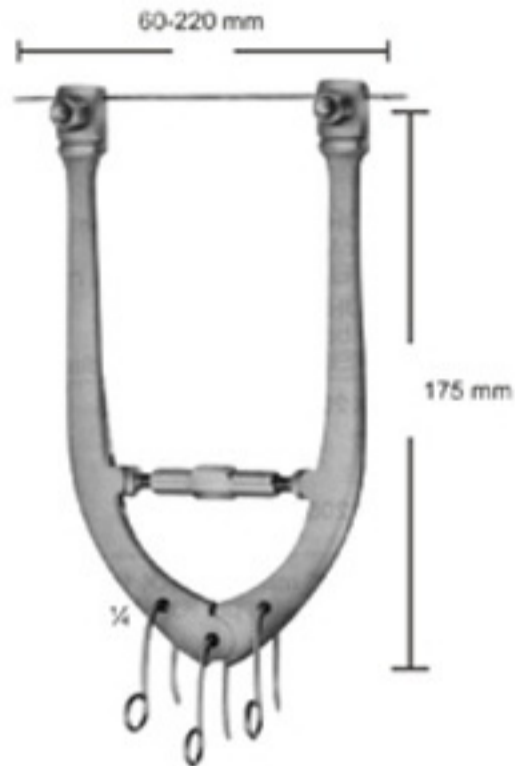

23-114
Wire traction bow, adjustable,
with 3 hooks, large size

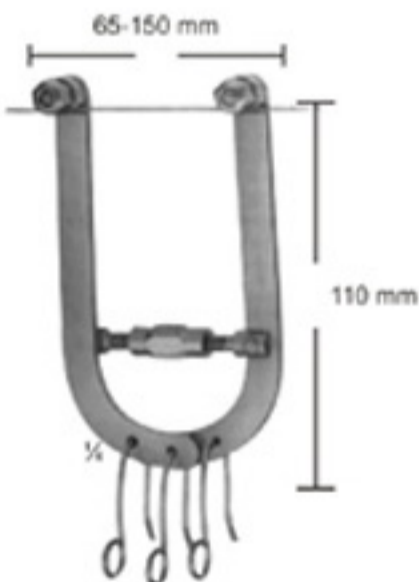

23-115
Wire traction bow, adjustable,
with 3 hooks, large size for
elbow and calcaneus, for
adolescents



23-116	105 mm
23-117	160 mm
23-118	200 mm
23-116	1,6 mm
23-117	2,0 mm
23-118	2,5 mm

23-116 - 118
KIRSCHNER
Wire traction bow, modified
adjustable in with width, holds wire
securely, with 1 hook



23-119
Fixation disc, slotted



23-121
Fixation disc, slotted



23-120
idem, aluminum, transparent
to X-rays



23-122
Screw driver, for above
fixations discs



23-123 - 130
Screw driver, for above
fixations discs

Steinmann pins, 4 mm daim.		Steinmann pins, 5 mm daim.
23-123 with pin		16x9cm Arm
23-124 without pin	23-129 without	
23-125 with pin		21x11cm Arm
23-126 without pin	23-130 without	
23-127 with pin		21x15cm Arm
23-128 without pin		



23-131
SCHWARZ
Traction bow for fingers,
to be used with KIRSCHNER-
wire up to 1.6 mm diam.



23-132
Small distractor
as a repositioning device for
distraction and compression of small bones,
for wires with 3.0 mm diam.



23-133 - 147
STEINMANN
 triangular shaft ended and trocar point

Length	4,0 mm	5,0 mm
80 mm	23-133	
100 mm	23-134	
120 mm	23-135	
140 mm	23-136	
150 mm	23-137	23-143
160 mm	23-138	
180 mm	23-139	23-144
200 mm	23-140	23-145
210 mm	23-141	
250 mm	23-142	23-146
300 mm		23-147



$\frac{1}{4}$
23-148
 Protection cap
 for 4,0 mm STEINMANN Pins



$\frac{1}{4}$
23-149
 Protection cap
 for 5,0 mm STEINMANN Pins



23-150
REILL
Drilling chuck,
cannulated,
for shanks from
2.0 - 2.5 mm diam
115 mm



23-151
Drilling chuck,
cannulated,
for shanks from
0.8 - 2.0 mm diam
150 mm



23-152
Drilling chuck,
cannulated,
for shanks up to
4.5 mm diam
with key
140 mm



23-153
LOUTE
Wire tightener, improved pattern,
with movable tip,
for wires up to 1.0 mm diam.
220 mm



23-154
Drilling chuck, cannulated,
for shanks up to 6.35 mm diam.,
To be tightened by hand
100 mm



23-155
Drilling chuck, cannulated,
for shanks up to 4.5 mm diam.,
And for triangular shaft width
across flats 4.7 mm



23-156
Drilling chuck, cannulated,
for shanks up to 6.35 mm diam.,
With key
160 mm

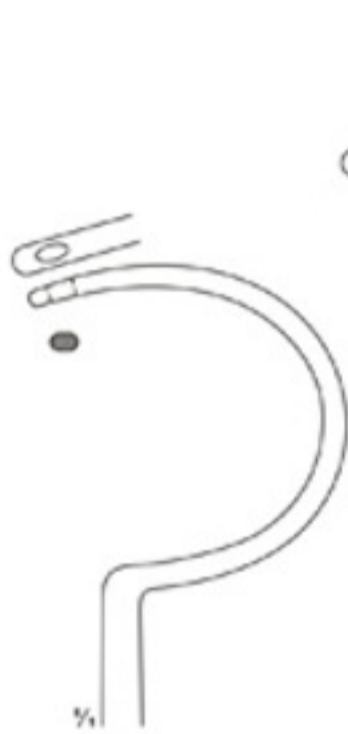

23-157
275 mm



23-158
285 mm

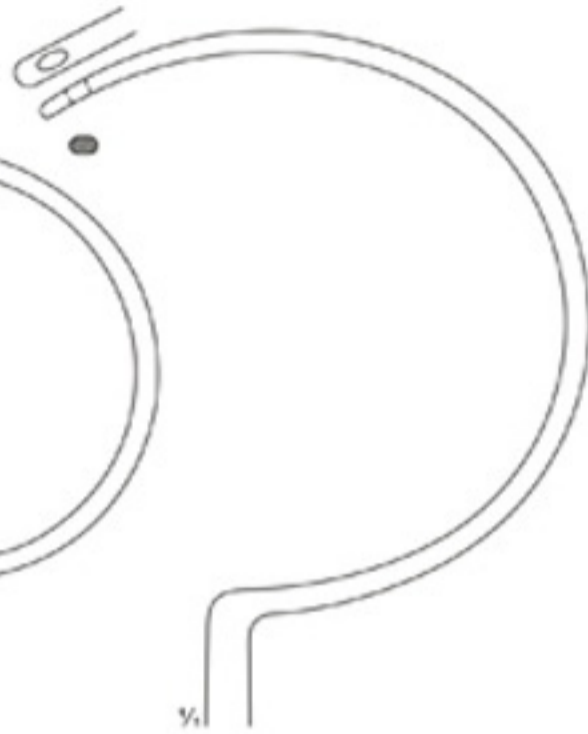

23-159
305 mm



23-157 - 159
DEMEL
Wire guides

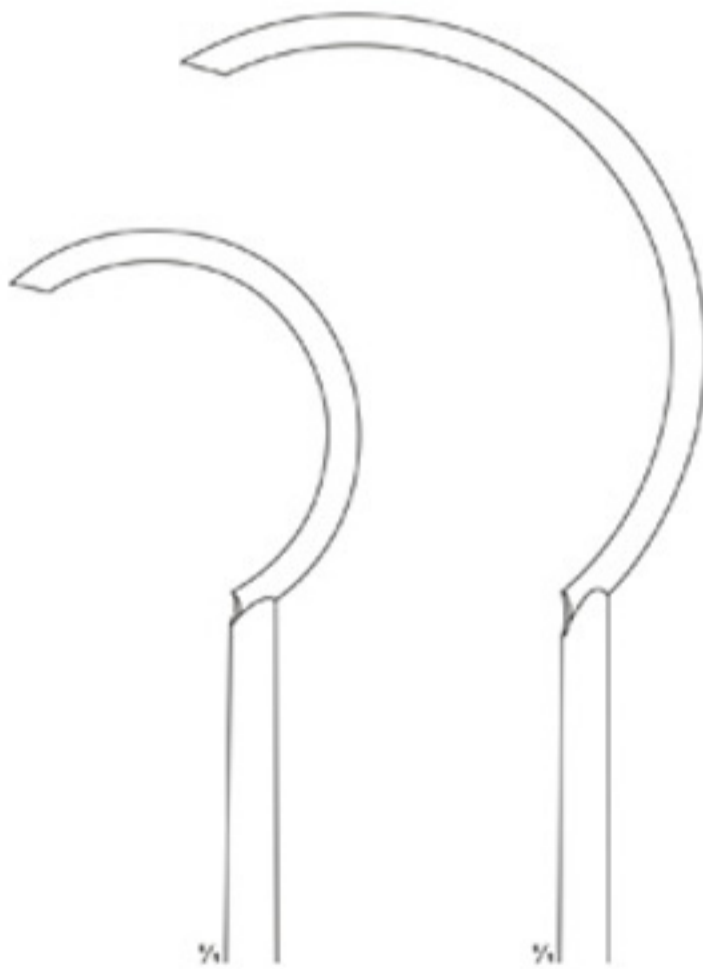

23-160
240 mm

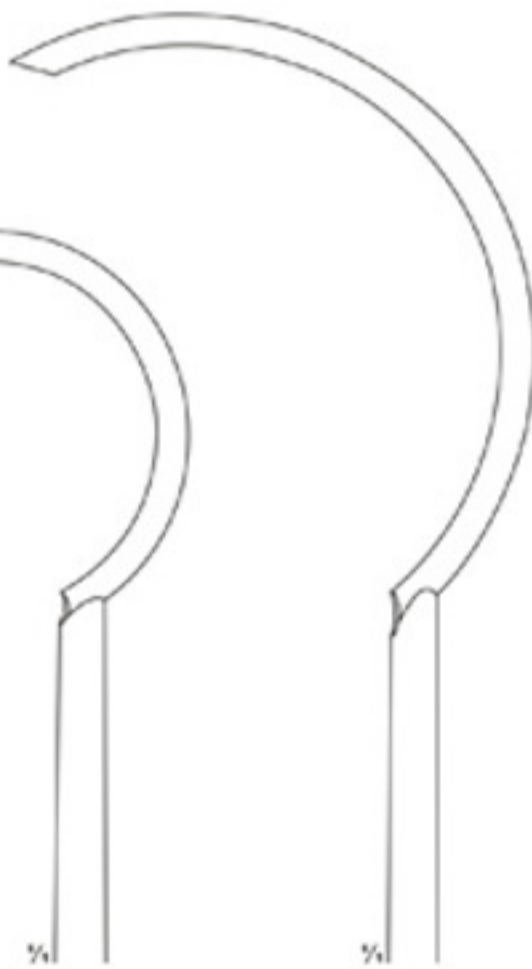

23-161
270 mm



23-162
225 mm



23-163
JORDAN
Wire tightener



23-164
JORDAN
Wire twister
170 mm



23-165
JORDAN
Wire catcher
180 mm



23-166
JORDAN
Probe, cannulated
170 mm



23-167
DUROGRIP
Holding forceps for cerclage wire, with lateral jaws to avoid wire slipping off
170 mm



23-168
DUROGRIP
Wire, tightening pliers, Ligature pliers
150 mm



23-169
DUROGRIP
Wire, tightening pliers, Ligature pliers
150 mm



23-170
with serrated jaws
140 mm



23-171
one jaws smooth, one jaws serrated
140 mm



23-172
with serrated jaws
23-173
with longitudinal and transversal grooves
170 mm



23-174
190 mm

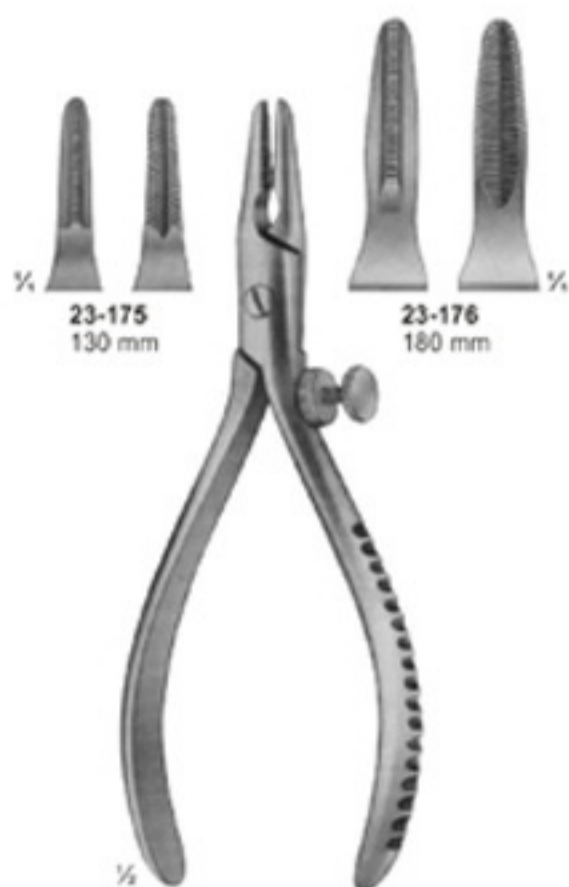

23-175
130 mm

23-176
180 mm

23-175 - 176
Extraction pliers
for boring wires



23-177
Flat-nosed pliers,
parallel
185 mm

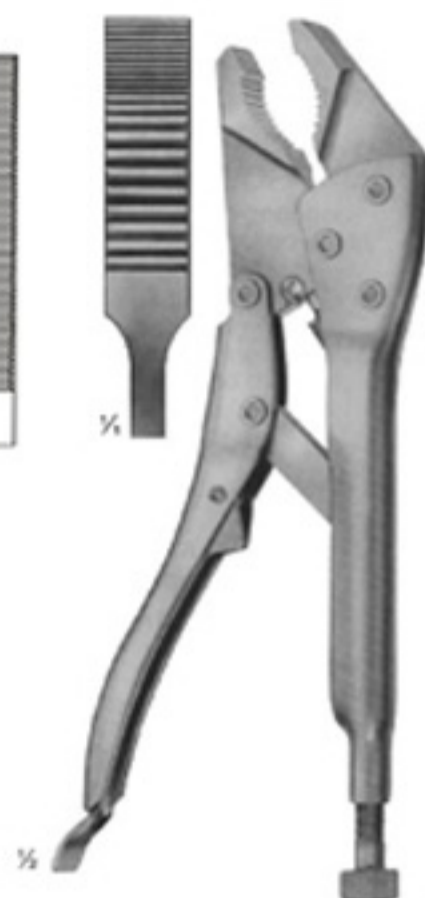

23-178
Vise grip
200 mm



23-179 - 183
Round pliers
180 mm

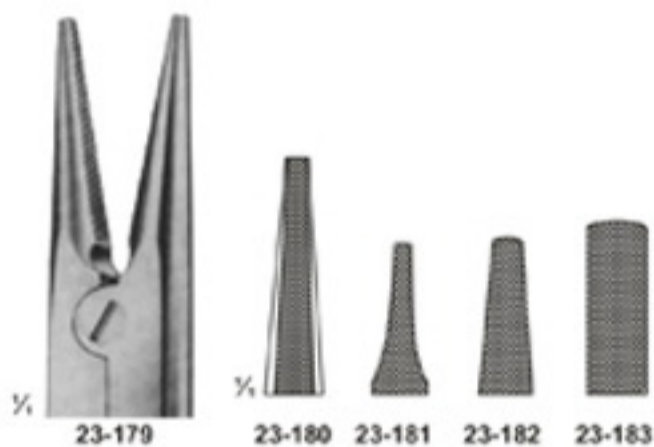

23-180
23-181 145 mm
23-182 180 mm
23-183 180 mm
Extraction pliers for wires



23-184
Bending pliers
for wires up to
1.8 mm diam.



23-185
ANGLE
130 mm

for soft wire
up to diam.
for hard wire
up to diam.

23-186
DURCTIP
ANGLE
130 mm

0,5 mm 0,6 mm
0,3 mm 0,4 mm

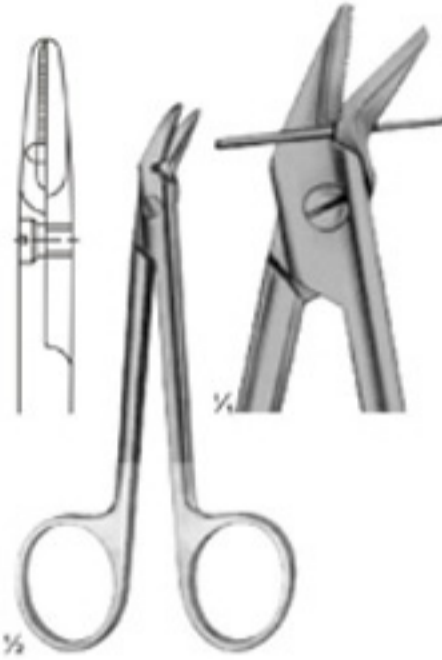

23-187
120 mm

for soft wire
up to diam.
for hard wire
up to diam.

23-188
DUROTIP
120 mm

1,2 mm 1,2 mm
0,8 mm 0,8 mm



23-189
HARVEY
125 mm

0,4 mm
0,3 mm



23-190
150 mm

for soft wire
up to diam
for hard wire
up to diam

1,5 mm
1,0 mm



23-191
160 mm

1,5 mm
1,2 mm



23-192
140 mm

1,5 mm
1,0 mm



23-193
180 mm

for soft wire
up to diam. 2,0 mm
For hard wire 1,5 mm
up to diam
specially hardened
cutting edges, front
and lateral cutting
action



23-194
REILL
175 mm

for soft wire
up to diam. 2,0 mm
For hard wire 1,6 mm
up to diam
specially hardened
cutting edges, for
cutting off wires close
to the bone



23-195
235 mm

for soft wire
up to diam. 3,0 mm
For hard wire 2,2 mm
up to diam



23-196
240 mm

for soft wire
up to diam. 2,0 mm
For hard wire
up to diam. 1,6 mm



23-197
140 mm

for soft wire
up to diam. 1,5 mm
For hard wire
up to diam. 1,0 mm



23-198
145 mm

for soft wire
up to diam. 2,0 mm
For hard wire
up to diam. 1,5 mm



23-199
220 mm

for soft wire
up to diam. 3,5 mm
For hard wire
up to diam. 2,5 mm



Cutter for cutting off
KIRSCHNER wires,
Tibia head screws,
bolts, pins, up to 3 mm diam.

1/2

23-200
320 mm

for soft wire up to diam. 3,0 mm
For hard wire up to diam. 3,0 mm



Durotip

23-201
Cutter for cutting off
KIRSCHNER wires,
Tibia head screws,
bolts, pins, up to 6 mm diam.
470 mm

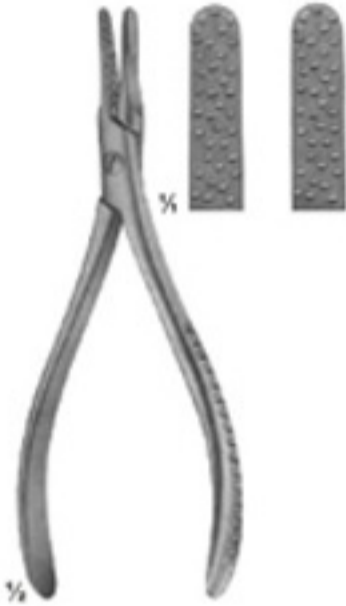

23-202
Nail extracting
forceps
135 mm



23-203
Nail extracting
forceps
145 mm



23-204 - 206
Finger nail drill
with 3 points

Drill points only

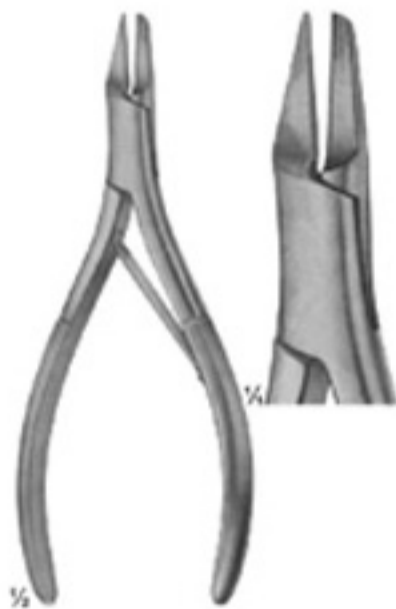

23-207
Nail splitting
forceps
135 mm



23-208
SYSTRUNK
Scissors, for splitting
finger nails
130 mm



23-209
Finger ring saw
150 mm

Spare blade



with ebony handle

24-101
HOPKINS
200 mm



24-102
ESMARCH
180 mm



24-103
ENGEL
160 mm



1/2

24-104 - 112

- | | | | |
|--------|-------|--------|-------------|
| 24-104 | black | 24-108 | yellow |
| 24-105 | red | 24-109 | white |
| 24-106 | blue | 24-110 | orange |
| 24-107 | green | 24-111 | lavender |
| | | 24-112 | bright pink |



1/2

24-113 - 121

- | | | | |
|--------|-------|--------|-------------|
| 24-113 | black | 24-117 | yellow |
| 24-114 | red | 24-118 | white |
| 24-115 | blue | 24-119 | orange |
| 24-116 | green | 24-120 | lavender |
| | | 24-121 | bright pink |

For small plaster dressings





24-129
STILLE-AESCULAP
260 mm



24-130
STILLE-AESCULAP
360 mm

Blade with reinforced back



24-131
STILLE
230 mm

24-132
Spare blade



24-133
STILLE
370 mm

24-134
Spare blade



24-135
STILLE
240 mm

24-136
Spare blade



24-137
HENING
270 mm



24-138
MOD.USA
230 mm



24-139
290 mm



with removable jaws



24-140 - 141
WOLFF
24-140 180 mm
24-141 240 mm

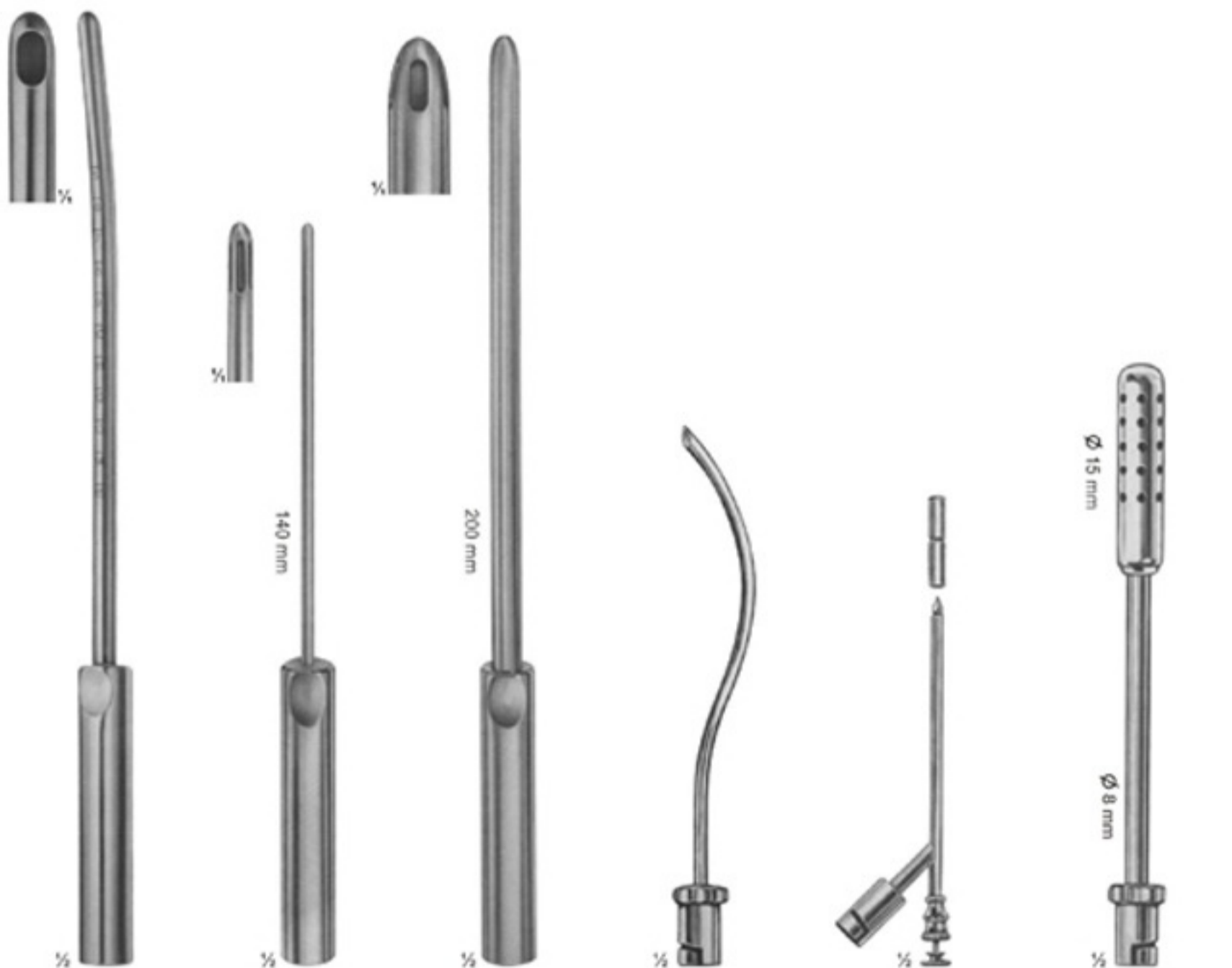

25-101 - 106
BIEMER
25-101 ø 4 mm
25-102 ø 6 mm
25-103 ø 8 mm
25-104 ø 10 mm
25-105 ø 12 mm
25-106 ø 14 mm
Curettes for aspiration lipectomy, graduated, slightly curved

25-107 - 108
BIEMER
25-107 ø 4 mm
25-108 ø 6 mm
Curettes for aspiration lipectomy, with three apertures, slightly curved malleable

25-109 - 111
BIEMER
25-109 ø 8 mm
25-110 ø 10 mm
25-111 ø 12 mm
Curettes for aspiration lipectomy, with three apertures, slightly curved malleable

25-112
For aspirating fluid from the excretory ducts of large glands and for keeping the operating area clear
170 mm

25-113
Trocar
For puncturing
150 mm

25-114
For clearing large quantities of fluid
190 mm



25-115
Trocar
For puncturing
170 mm



25-116
Hollow needle,
sharp
150 mm



25-117
double curved
For general
surgery
230 mm



25-118
For tonsillectomy,
oral and laryngeal
operations
190 mm



25-119
For tonsillectomy,
oral and laryngeal
operations
220 mm

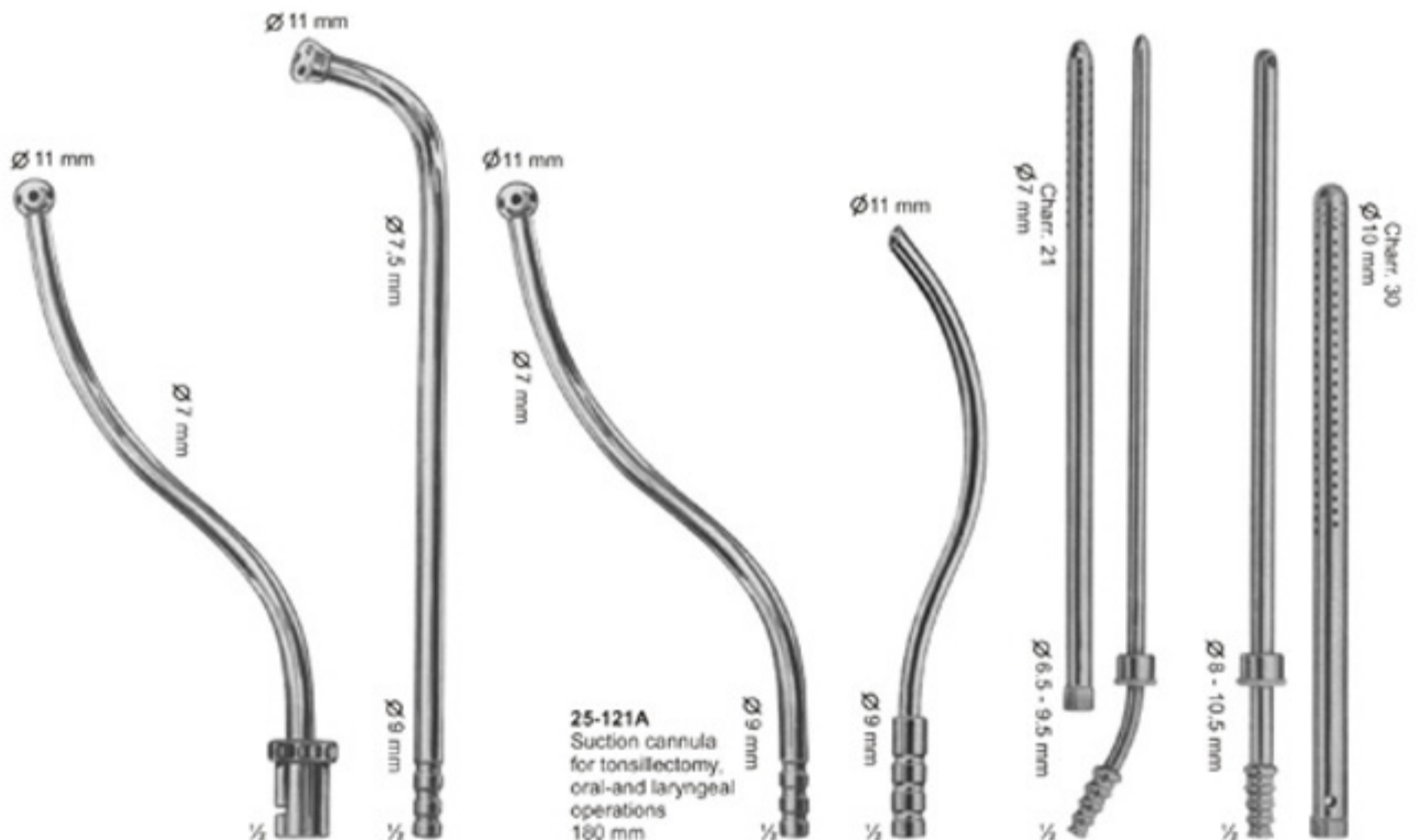

25-120
For tonsillectomy,
oral-and laryngeal
operations
180 mm

25-121
Suction cannula
for tonsillectomy,
oral-and laryngeal
operations
220 mm

25-121A
Suction cannula
for tonsillectomy,
oral-and laryngeal
operations
180 mm

25-122
S-shaped blunt cannula
for aspirating fluid from
the excretory ducts of
large glands and for
keeping the operations
area clear
170 mm

25-123
POOL
Suction cannula,
with outer tube
to be screwed of
225 mm

25-124
POOL
Suction cannula,
with outer tube
to be screwed of
225 mm

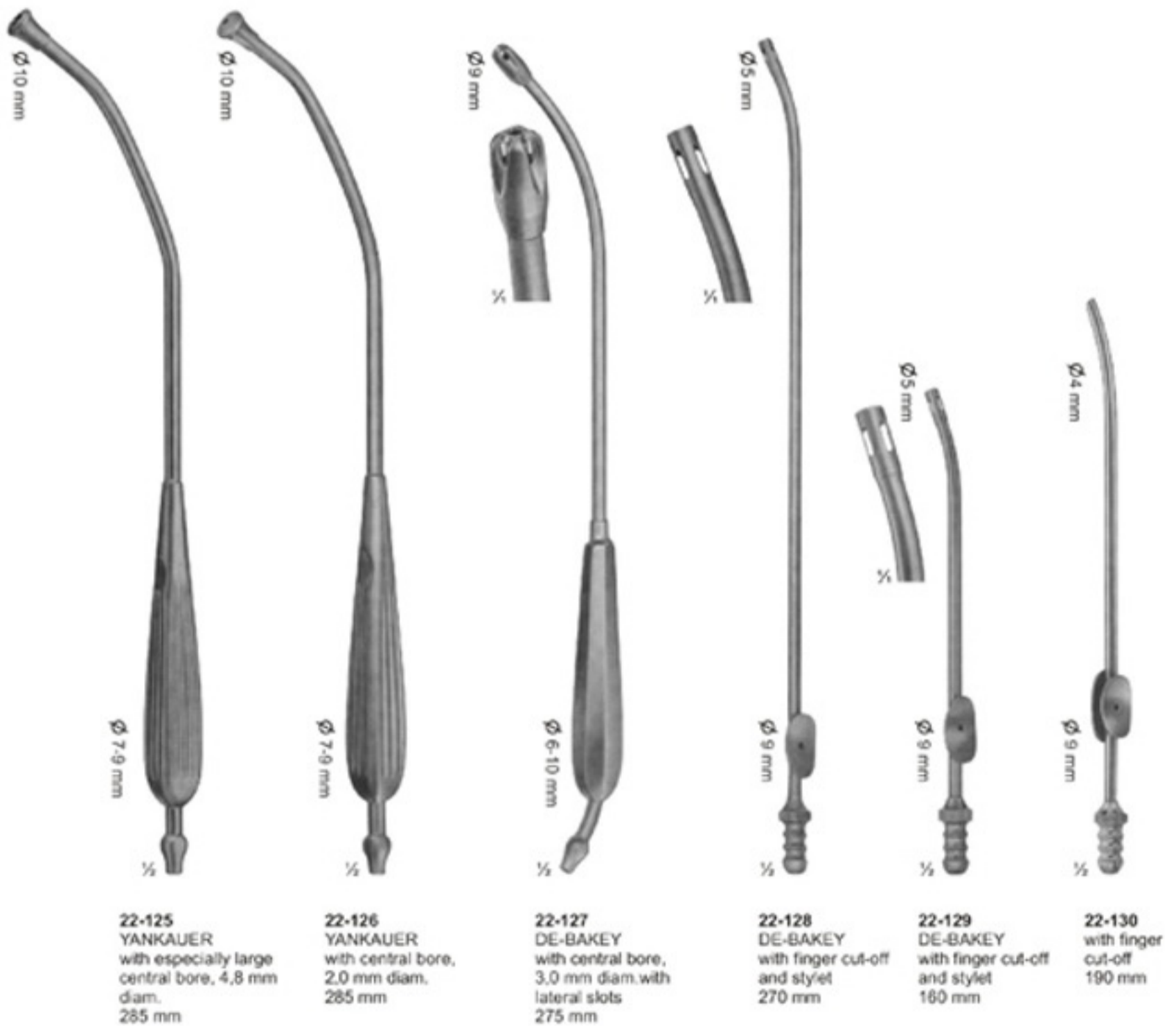

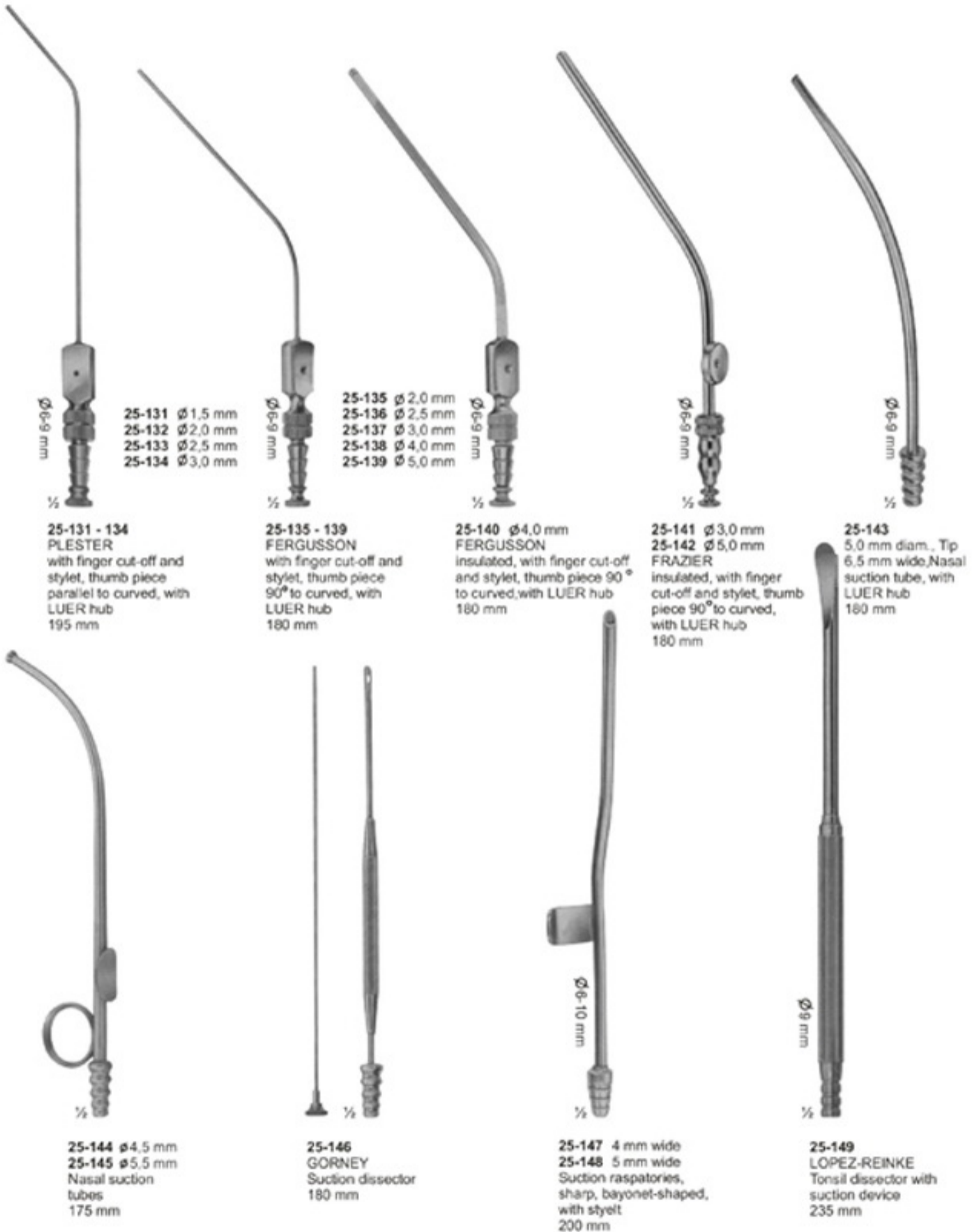

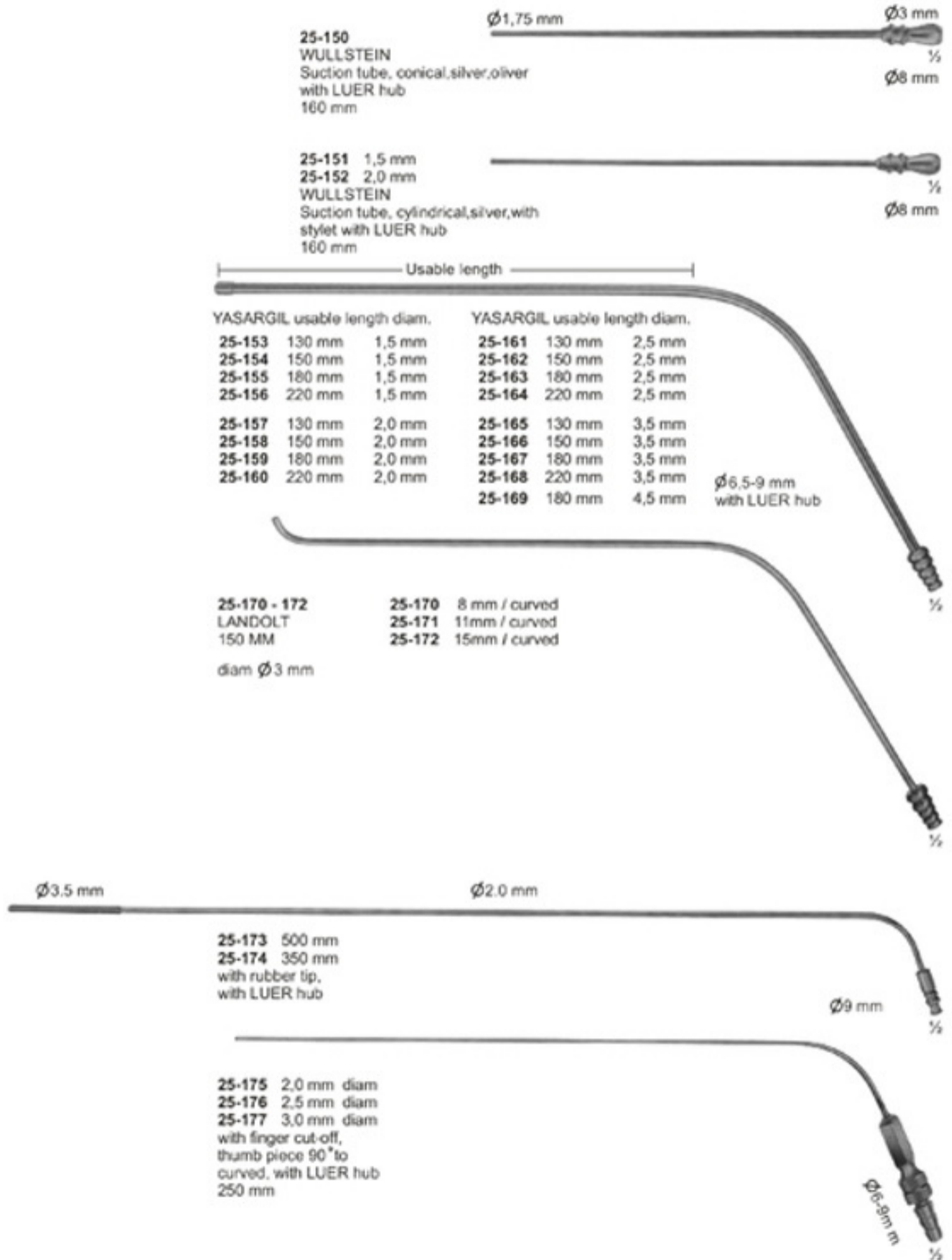

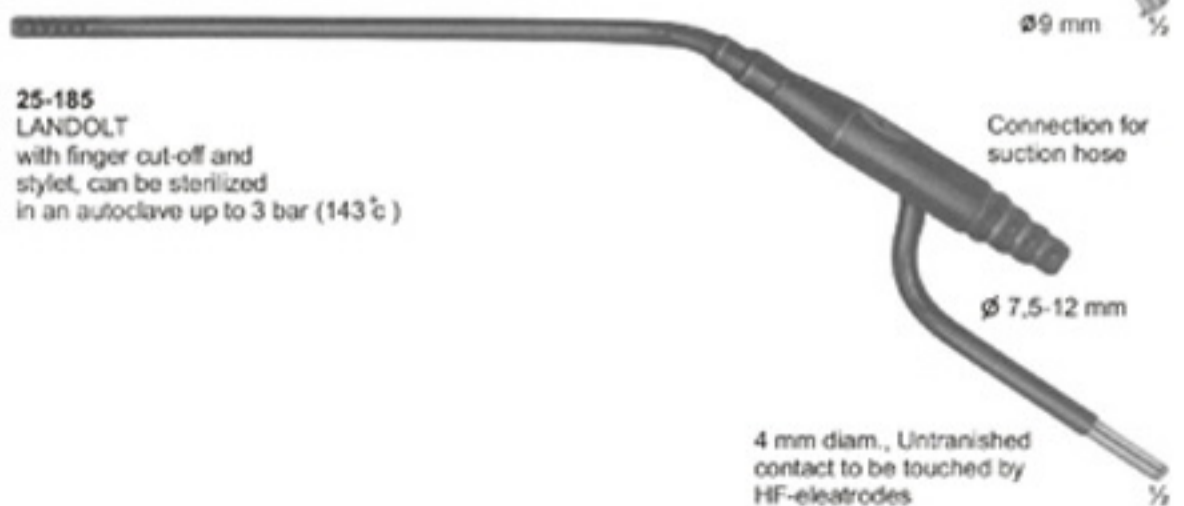
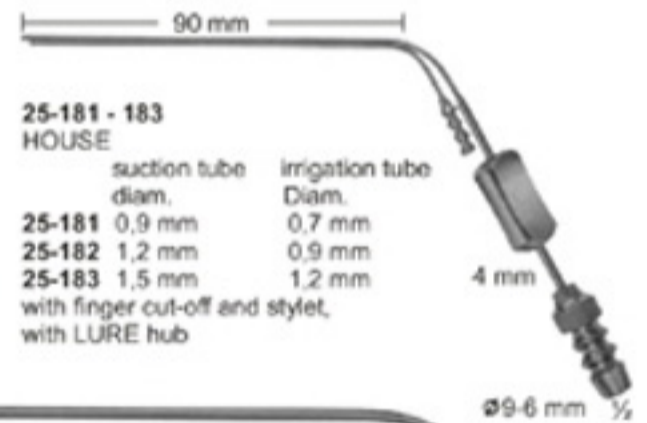
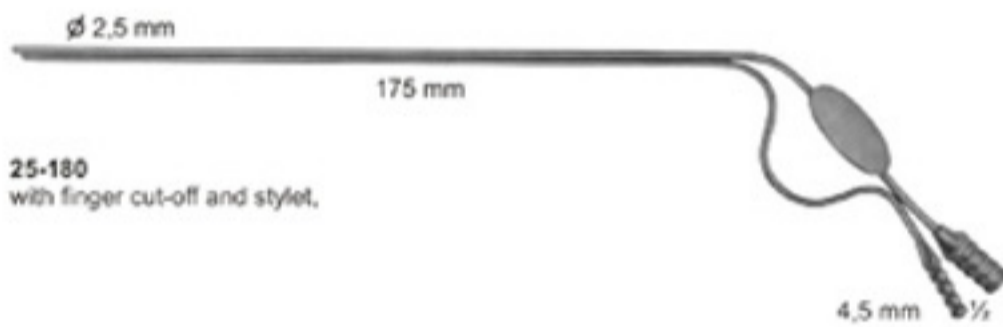
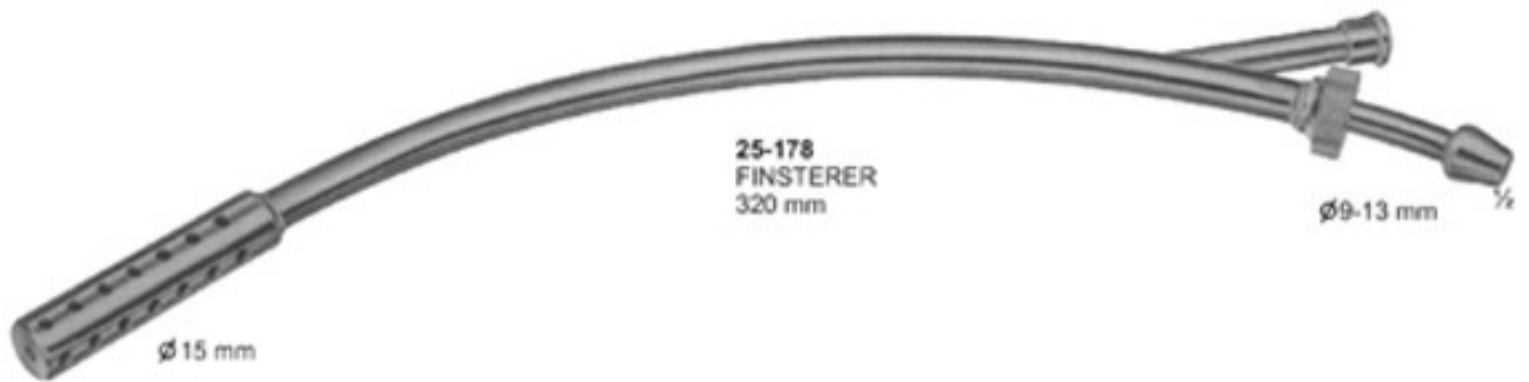



26-101
Standard

14,5cm
16,5cm
18,5cm



26-102
Standard

14,5cm
16,5cm
18,5cm



26-103
Standard

14,5cm
16,5cm
18,5cm



26-104
Standard

14,5cm
16,5cm
18,5cm



26-105
Standard

14,5cm
16,5cm
18,5cm



26-106
Standard

14,5cm
16,5cm
18,5cm

Scissors with Tungsten Carbide Inserts













26-136
Universal
12cm



26-137
Ligature Scissors
1 Black & 1 Goldplated ring
14cm 17cm 23cm



26-138
Adson
12cm 15cm



26-139
Cushing
17,5cm



26-140
Cushing
18cm



26-141
Cushing-Taylor
18cm



26-142
Dissecting Forceps
15cm



26-143
Semken
15cm

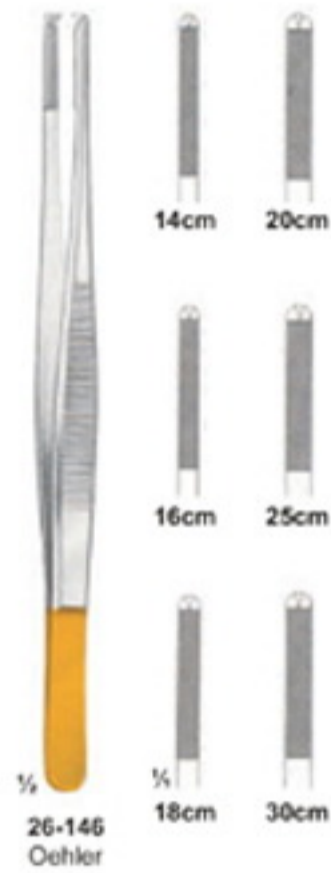
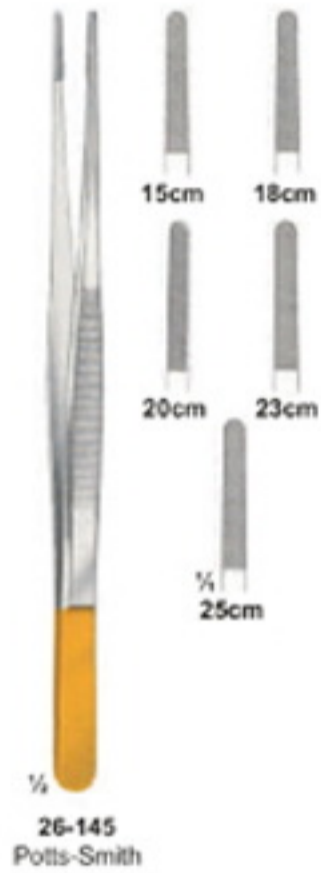



26-152
Arruga
16cm



26-153
Castroviejo
13cm



26-154
Hegar
20cm 24cm

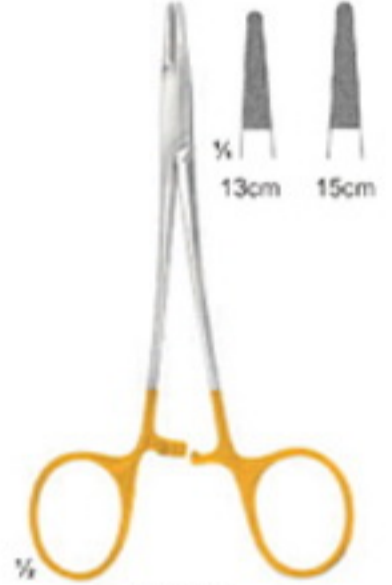

26-155
Halsey
13cm 15cm



26-156
Mayo-Hegar
16cm 18cm 20cm
24cm 26cm 30cm



26-157
De-Bakey
18cm 20cm 23cm
26cm 31cm 37cm



26-158
Hegar-Vascular
14cm 18cm
20cm 23cm



26-159
Bozemann-Wertheim
20cm 24cm 26cm



26-160
Stratte
22cm 23cm

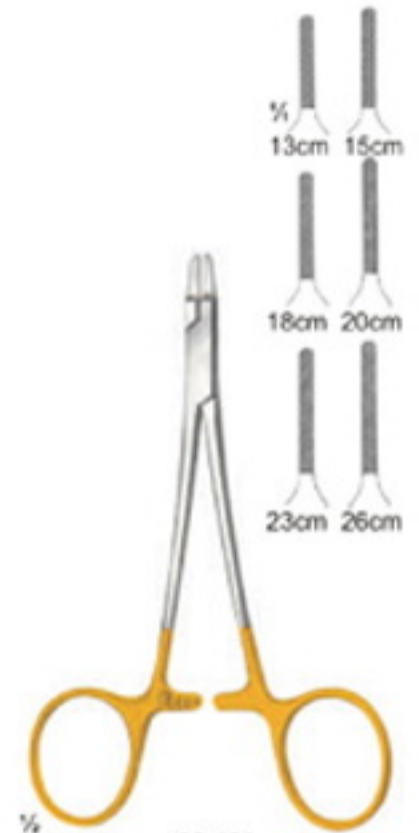

26-161
Ryder
13cm 15cm 18cm
20cm 23cm 26cm



26-162
Ryder-Vascular
13cm 15cm 18cm
20cm 23cm 26cm



26-163
Martin
15cm 17cm 20cm



26-164
Sarot
18cm 20cm 26cm





1/2
26-172
Mathieu-Ryder
17cm
20cm 24cm



1/2
26-173
Lichtenberg
20cm



1/2
26-174
Langhals
20cm 25cm



1/2
26-175
Lichtenberg
20cm 25cm



1/2
26-176
Luehty-Beck
20cm 25cm



1/2
26-177
Luehty-Beck
20cm 25cm



1/2
26-178
Langebeck
18cm
20cm 23cm



1/2
26-179
Langebeck-beck
18cm
20cm 23cm





27-101 - 115
Schimmelbusch

	Ø x H sizes in mm
27-101	80 x 80
27-102	105 x 120
27-103	140 x 140
27-104	160 x 120
27-105	160 x 150
27-106	190 x 150
27-107	190 x 190
27-108	240 x 160
27-109	240 x 240
27-110	290 x 160
27-111	290 x 240
27-112	340 x 160
27-113	340 x 340
27-114	390 x 190
27-115	390 x 290



27-116
Box
120 x 65 x 13mm
(without Bulldog clamps,
without silicone tape)



27-117
Box with support
120 x 65 x 13 mm
(ohne Bulldogklemmen)



27-118
Box with support for
needle electrodes,
without instruments

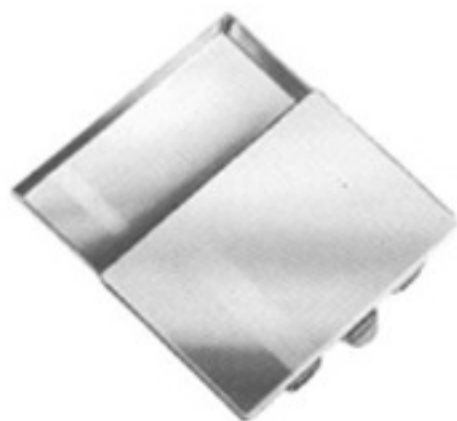

27-119 - 121
50 x 25 x 4,5 mm
27-120
65 x 42 x 8 mm
27-121
75 x 25 x 4,5 mm



27-122
Ø 65mm x 15mm



27-123 - 131

	Ø x H
27-123	30 x 90 mm
27-124	50 x 100 mm
27-125	50 x 130 mm
27-126	50 x 175 mm
27-127	75 x 100 mm
27-128	75 x 130 mm
27-129	75 x 175 mm
27-130	100 x 175 mm
27-131	100 x 200 mm



27-132 - 139

27-132	165 x 85 x 35 mm
27-133	200 x 100 x 35 mm
27-134	200 x 100 x 50 mm
27-135	230 x 130 x 50 mm
27-136	260 x 150 x 50 mm
27-137	270 x 235 x 50 mm
27-138	300 x 200 x 50 mm
27-139	325 x 275 x 50 mm



27-140
205 x 105 x 35 mm



27-141 - 142

- 27-141** Martin Sterilizing Forceps
 consisting of:
 1 Sterilizing Forceps, curved, 25 cm,
 without ratchet, with lid for jar
 1 jar with bottom plate (anti-tilt)
- 27-142** ditto, with 32 cm long Sterilizing Forceps



27-143 - 148

	Ø x H
27-143	75 x 60 mm
27-144	75 x 75 mm
27-145	100 x 60 mm
27-146	100 x 100 mm
27-146A	125 x 80 mm
27-147	125 x 125 mm
27-148	150 x 150 mm



27-149
25 cc

27-150
50 cc



27-151
20 cc
Medicine Spoon



27-152
Ø75 x 12 mm
Tablet Tray



27-153
Ø90 x 90 mm
Metal Cup



27-154
Ø75 x 80 mm
Sputum Cup



Kidney Dish



27-155 - 157

27-155	170 x 100 x 35 mm
27-156	250 x 140 x 40 mm
27-157	275 x 150 x 45 mm



27-158 - 165



27-166 - 170

	Ø x H		
27-158	40 x 19	mm	0.05L
27-159	61 x 30	mm	0.07L
27-160	80 x 40	mm	0.14L
27-161	116 x 50	mm	0.35L
27-162	128 x 55	mm	0.45L
27-163	147 x 65	mm	0.70L
27-164	167 x 75	mm	1.10L
27-165	187 x 85	mm	1.60L

27-166	116 x 35	mm	0.30L
27-167	128 x 38	mm	0.40L
27-168	147 x 40	mm	0.50L
27-169	157 x 45	mm	0.75L
27-170	187 x 45	mm	1.00L



27-171
Ø 110 x 28 mm 0.15L



27-172
100 cc 0.1L



27-173 - 176
27-173 0.25L
27-174 0.50L
27-175 1.00L
27-176 2.00L



27-177
235 x 190 x 40 mm



27-178
Ø 220 x 70 mm



27-179
 ϕ 50 x 100 mm
 Powder Pot



27-180
 ϕ 50 x 75 mm
 Methot With Lid



27-181
 ϕ 50 x 75 mm
 Methot Without Lid



27-182

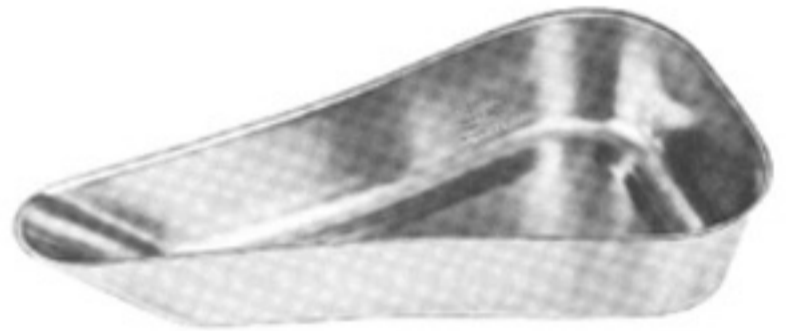

27-183



27-184

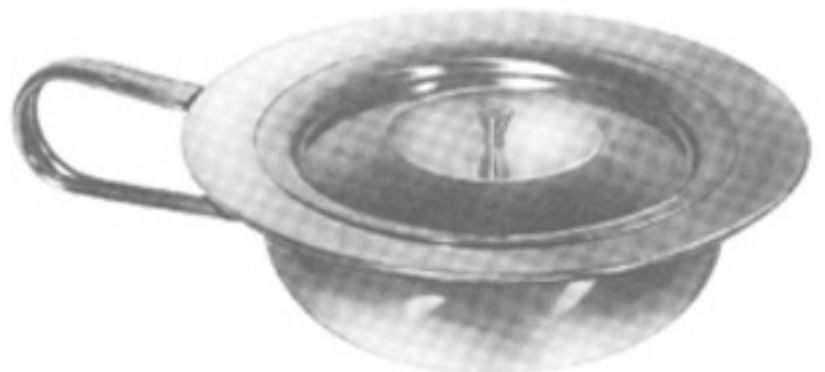

27-185 - 186

27-185 ϕ 235 mm
27-186 ϕ 310 mm



27-187
Sauerbruch
210 x 125 x 17 mm



27-188
Sauerbruch
210 x 125 x 17 mm



27-189
150 x 95 x 13 mm



27-190
150 x 95 x 13 mm



27-191
150 x 95 x 13 mm



27-192
150 x 95 x 13 mm



27-193
150 x 95 x 13 mm



27-194
150 x 95 x 13 mm



27-195
150 x 95 x 11 mm



27-196
Deponette
245 x 135 x 35mm



27-197
Deponette
245 x 135 x 50mm



27-198
Deponette
245 x 135 x 60mm

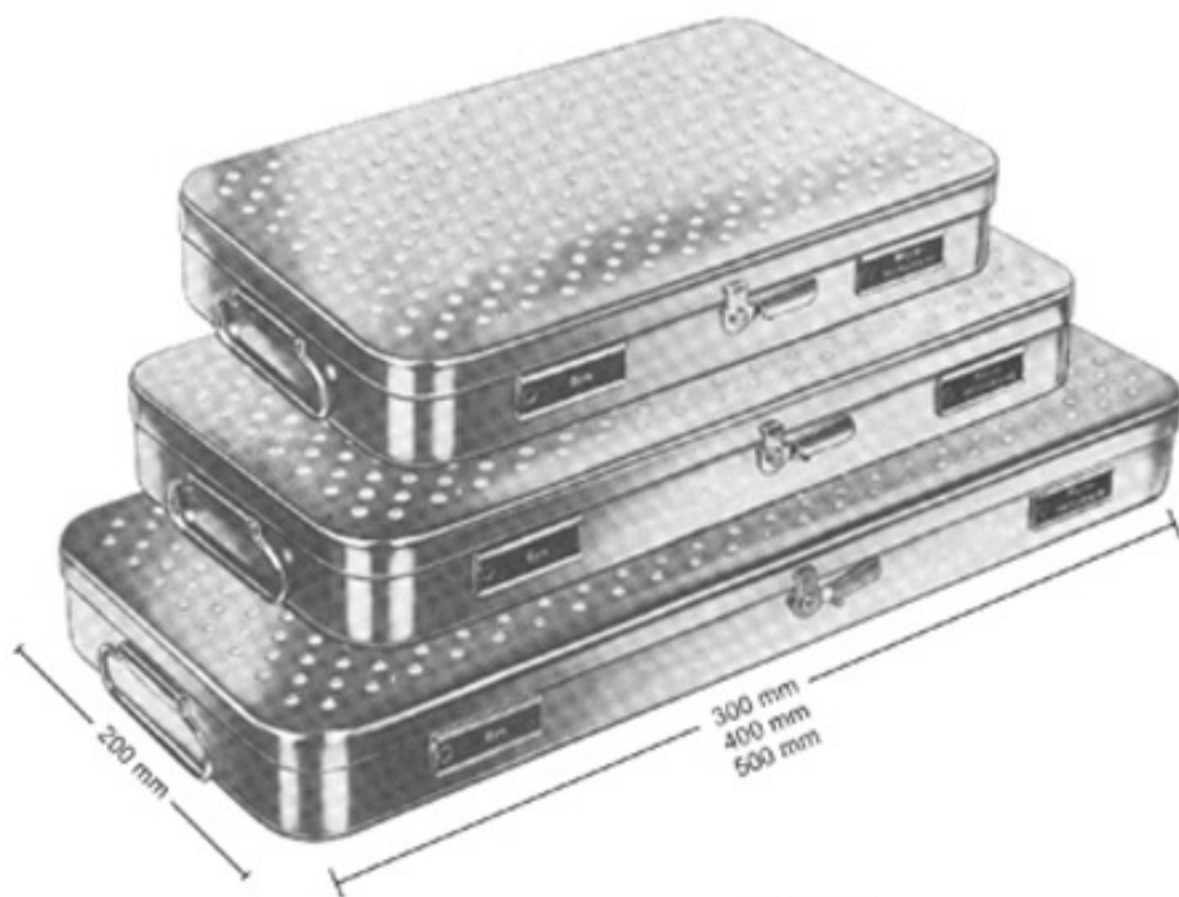

27-199 - 209

27-199	230 x 130 x 50	mm
27-200	260 x 150 x 50	mm
27-201	275 x 235 x 50	mm
27-202	300 x 200 x 50	mm
27-203	325 x 275 x 50	mm
27-204	420 x 175 x 50	mm
27-205	230 x 130 x 75	mm
27-206	260 x 150 x 75	mm
27-207	300 x 200 x 75	mm
27-208	325 x 275 x 75	mm
27-209	420 x 175 x 75	mm



27-210 - 212

27-210	480 x 250 x 50	mm
27-211	520 x 250 x 75	mm
27-212	520 x 250 x 100	mm



27-213 - 218

27-213	240 x 240 x 50	mm
27-214	240 x 240 x 80	mm
27-215	240 x 240 x 100	mm
27-216	480 x 260 x 50	mm
27-217	520 x 260 x 80	mm
27-218	520 x 260 x 100	mm

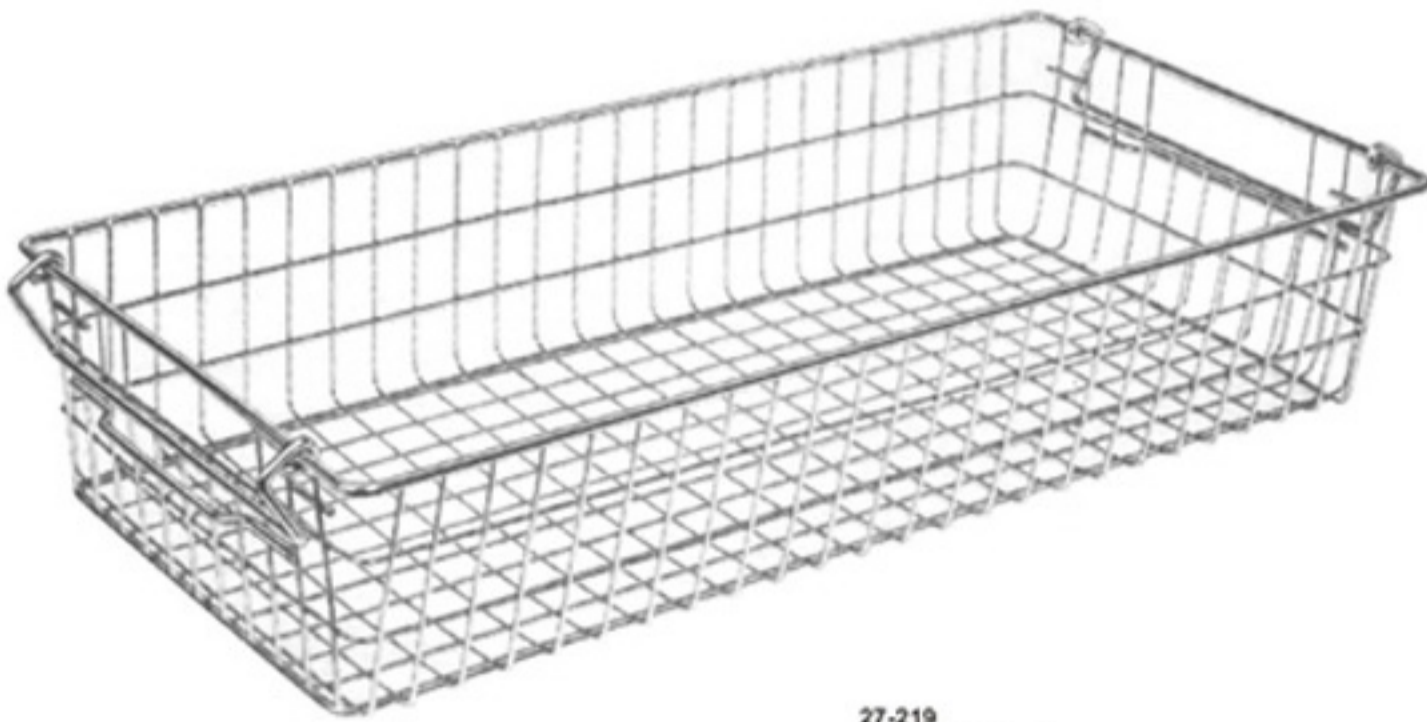

27-219
(60 x 30 x 15 cm)
Nominal dimensions



Buyers you Please Know OUR TERMS OF BUSINESS

01. All prices are F.O.B. while C.I.F. destination are also given.
02. Bank and Trade references should accompany with new orders from our new clients.
03. Payments against irrevocable letter of Credit. Bills on Sight draft will be drawn only if bank refernces are satisfactory.
04. Orders are subject to our acceptance without any liability on our part.
05. Special Instruments are prepared to the specifications of the clients to meet specific needs.
06. We will brand name and special marks on the products without charges if so desired.
07. Please give full shipping instructions on each order.
08. Shipment of goods made approximately of the date required unless otherwise stated on their order.
09. It cancels all our previous Export price List.
10. ***Contracts After Having Been Confirmed Are Strictly Binding.***



📍 **Saqalain International**
"Shabbir Villa" Khadim Ali Road,
P.O. Box 2716 Sialkot-Pakistan.

☎ (+92) 52-3552000

✉ info@saqalain.com

🌐 www.saqalain.com